



US00D929229S

(12) **United States Design Patent** (10) **Patent No.:** **US D929,229 S**  
**Pindor et al.** (45) **Date of Patent:** **\*\* Aug. 31, 2021**

- (54) **SPRAY CAN ACTUATOR**
- (71) Applicant: **B'laster LLC**, Valley View, OH (US)
- (72) Inventors: **Randy M Pindor**, Brecksville, OH (US); **Theodore Bradley**, North Ridgeville, OH (US); **Gregory L Skillicorn**, Akron, OH (US)
- (73) Assignee: **B'LASTER LLC**, Valley View, OH (US)
- (\*\*) Term: **15 Years**
- (21) Appl. No.: **29/708,310**
- (22) Filed: **Oct. 4, 2019**

- 6,293,436 B2 9/2001 Faughnder et al.
  - D476,558 S \* 7/2003 Cho ..... D9/685
  - 6,796,464 B1 9/2004 Tung
  - 7,070,072 B2 7/2006 Bonham
  - D536,970 S 2/2007 Shannan
  - 7,249,692 B2 \* 7/2007 Walters ..... B05B 11/3014  
222/153.11
  - D587,576 S \* 3/2009 Miller ..... D9/448
  - D659,534 S \* 5/2012 Taylor ..... D9/443
- (Continued)

**Related U.S. Application Data**

- (63) Continuation-in-part of application No. 16/138,576, filed on Sep. 21, 2018, now Pat. No. 10,464,736, and a continuation-in-part of application No. 29/664,157, filed on Sep. 21, 2018, now Pat. No. Des. 907,491.
- (51) **LOC (13) Cl.** ..... **09-07**
- (52) **U.S. Cl.**  
USPC ..... **D9/448**
- (58) **Field of Classification Search**  
USPC ..... D7/387, 392.1, 396.2; D9/434-436, 440, D9/443, 446-449, 454, 455, 499  
CPC ..... B65D 83/303; B65D 83/205  
See application file for complete search history.

**References Cited**

**U.S. PATENT DOCUMENTS**

- 3,083,872 A 4/1963 Meshberg
- 4,690,312 A 9/1987 Crapser
- 5,154,323 A 10/1992 Query et al.
- D358,989 S 6/1995 Woods
- D371,738 S \* 7/1996 Lamb ..... D9/448
- D380,384 S \* 7/1997 Ferrara, Jr. .... D9/448
- 6,105,882 A 8/2000 Woltjen

**OTHER PUBLICATIONS**

YouTube. B'laster ProStraw by BlasterCorpVideos. Sep. 23, 2019. [https://www.youtube.com/watch?v=tDtU249-dkw&feature=emb\\_logo](https://www.youtube.com/watch?v=tDtU249-dkw&feature=emb_logo) (Year: 2019).\*

*Primary Examiner* — Darcey E Gottschalk

(57) **CLAIM**

The ornamental design for a spray can actuator, as shown and described.

**DESCRIPTION**

FIG. 1 is a left side rear bird's eye perspective view of a spray can actuator of our new design, and with a movable straw shown in a down position;

FIG. 2 is a left side front ant's eye perspective view the design of FIG. 1;

FIG. 3 is a rear view of the design of FIG. 1;

FIG. 4 is a front view of the design of FIG. 1;

FIG. 5 is a right side view of the design shown in FIG. 4;

FIG. 6 is a left side view of the design of FIG. 4;

FIG. 7 is a top view of the design of FIG. 4;

FIG. 8 is a bottom view of the design of FIGS. 6 and 7; and,

FIG. 9 is a left side front bird's eye perspective view of the spray can actuator of FIG. 1, and with the moveable straw shown in an up position.

In the drawings, the broken lines depict unclaimed subject matter only and form no part of the claimed design.

**1 Claim, 6 Drawing Sheets**

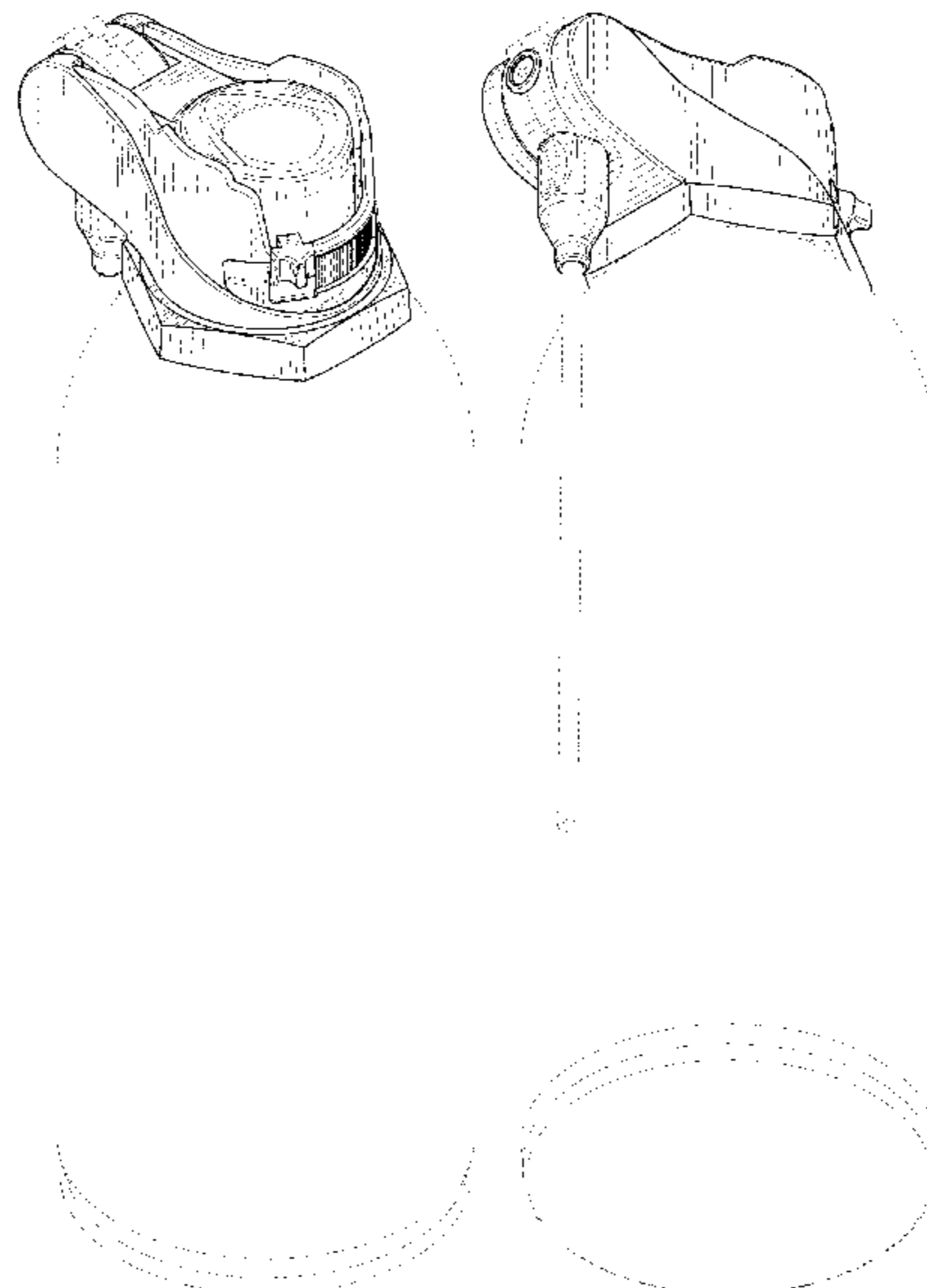

(56)

**References Cited**

U.S. PATENT DOCUMENTS

8,353,465	B2	1/2013	Tryon	
D691,040	S	10/2013	Wade et al.	
D710,697	S *	8/2014	Lind .....	D9/448
D723,368	S	3/2015	Checklin et al.	
D734,151	S *	7/2015	Herbst .....	D9/448
D746,135	S *	12/2015	Lind .....	D9/448
9,248,457	B2	2/2016	Hanson	
9,352,896	B2	5/2016	Deutsch	
10,065,791	B1	9/2018	Charles	
10,464,736	B1 *	11/2019	Pindor .....	B65D 83/303
2002/0053579	A1	5/2002	Baumgart	
2004/0164105	A1	8/2004	Stern	
2005/0173465	A1	8/2005	Roden	
2017/0203908	A1	7/2017	Sater et al.	
2019/0077580	A1 *	3/2019	Starzman .....	B05B 1/1645

\* cited by examiner



**Fig. 1**

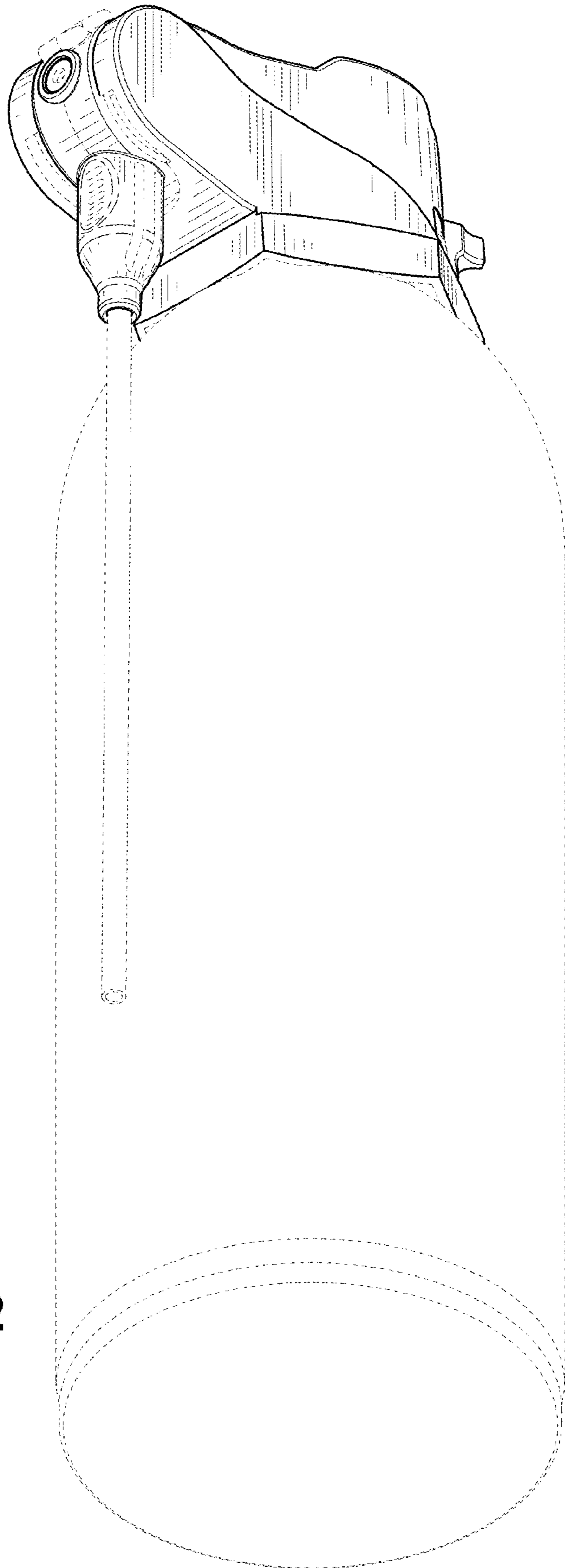

**Fig. 2**

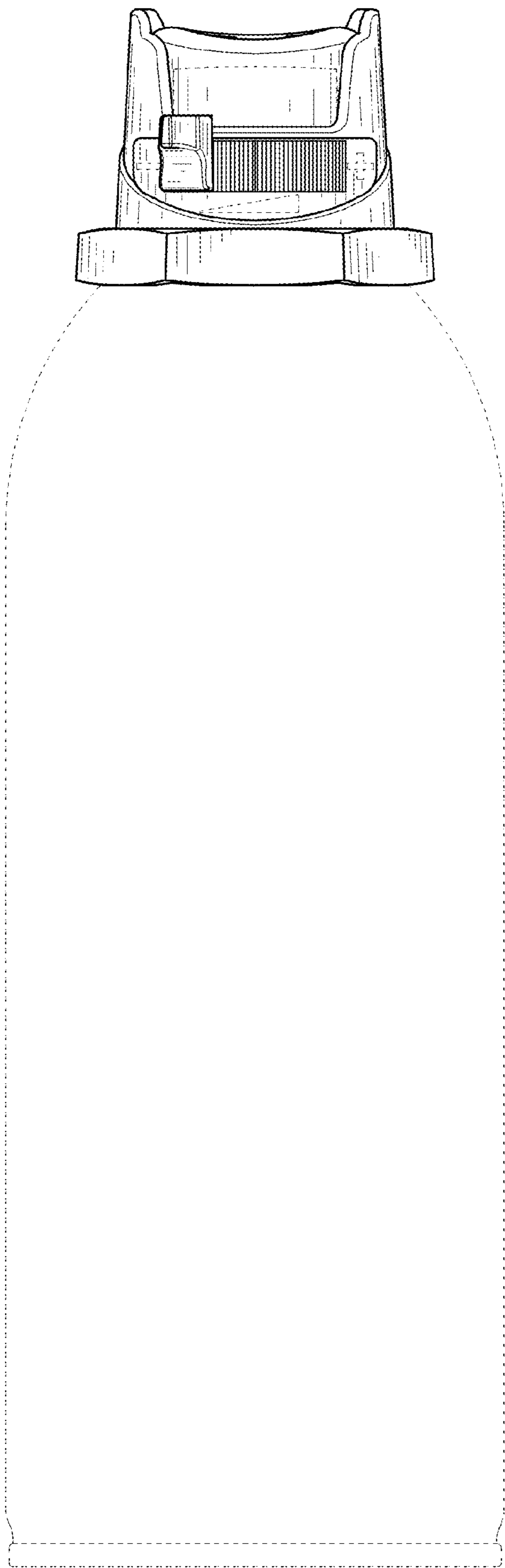

Fig. 3

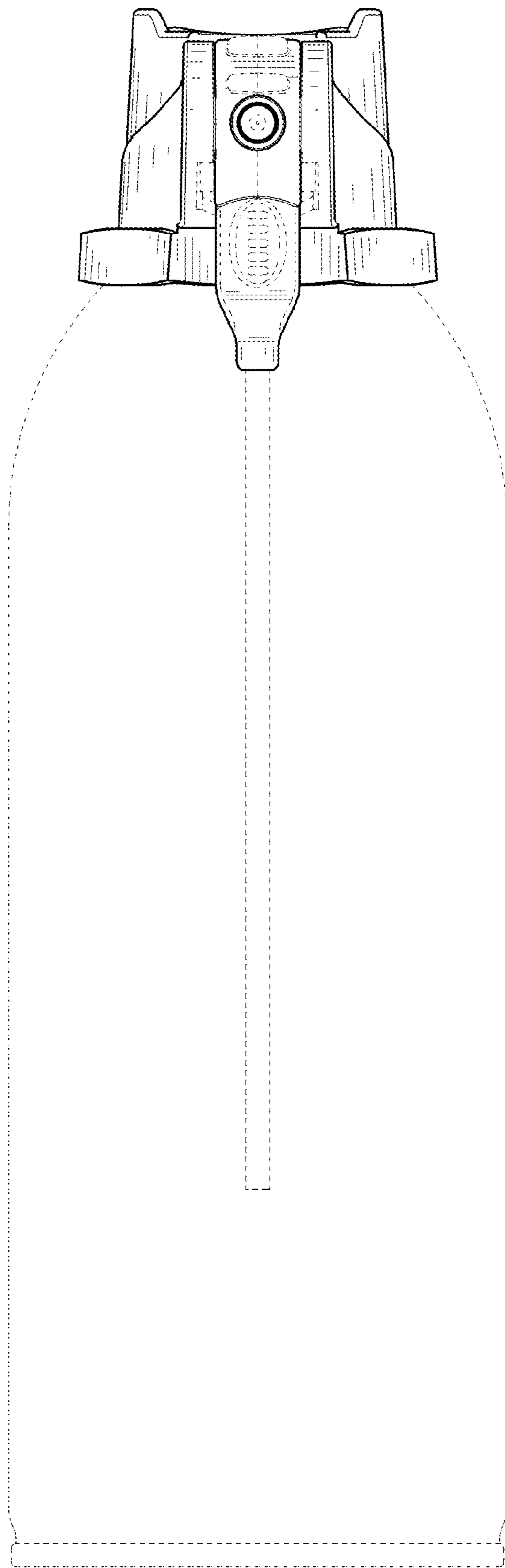

Fig. 4

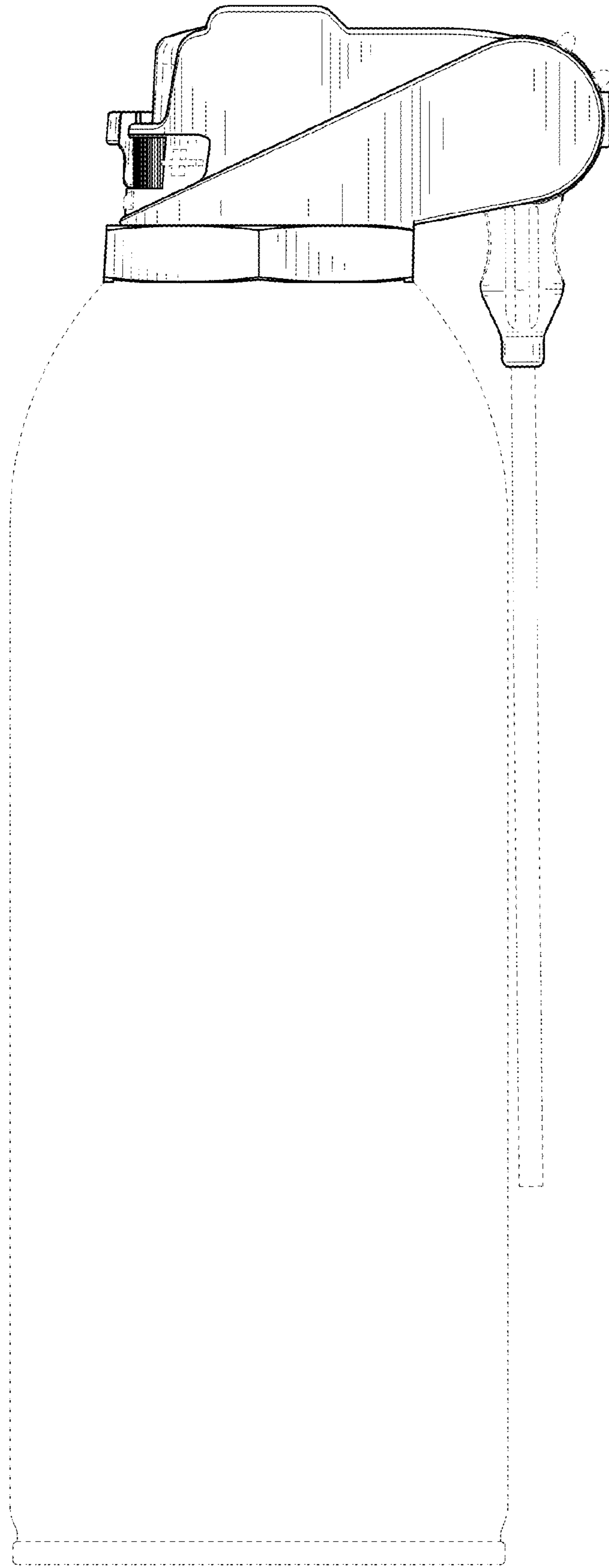
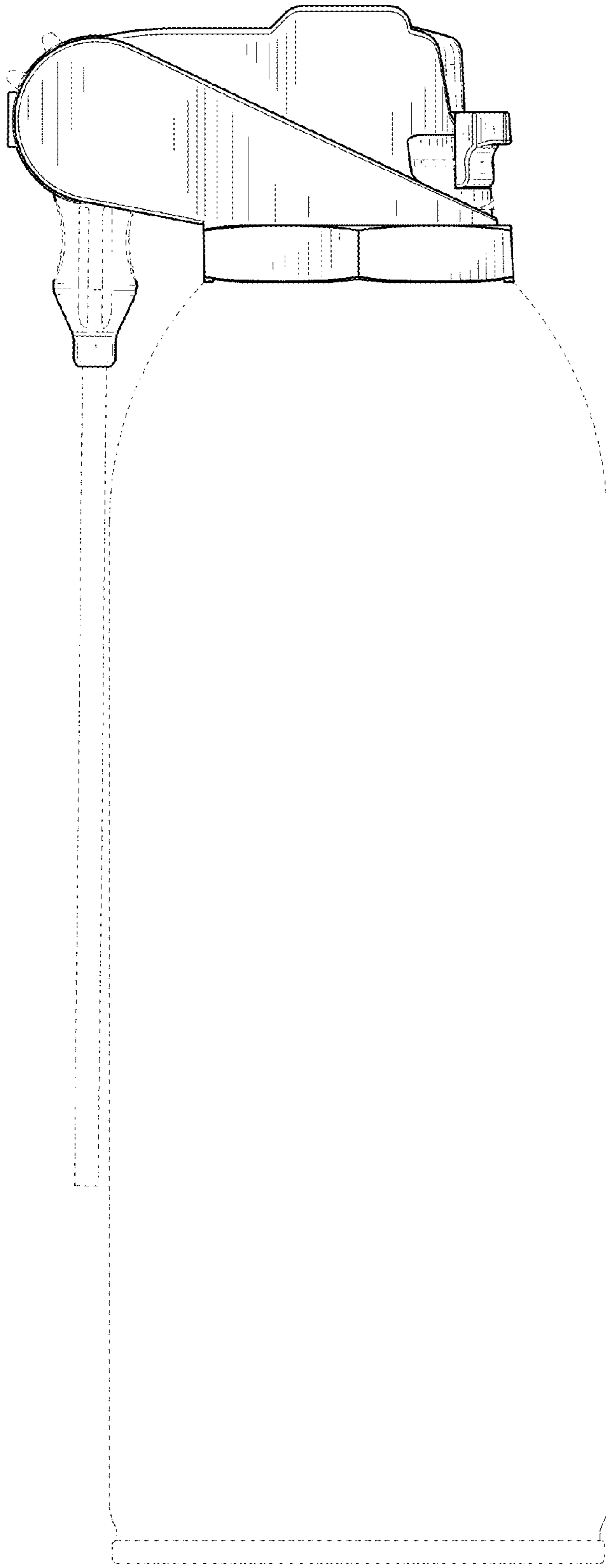
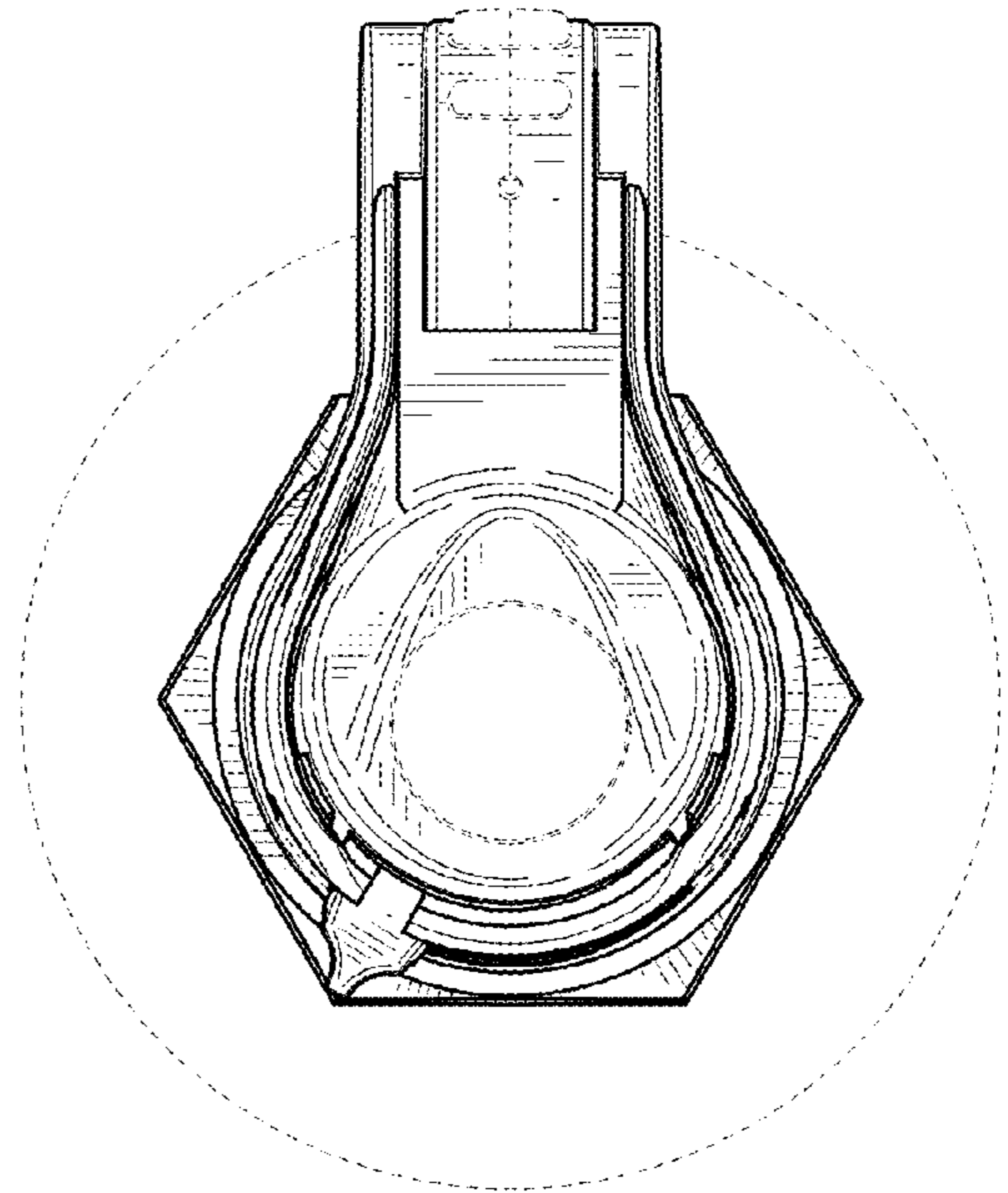

Fig. 5



**Fig. 6**



**Fig. 7**

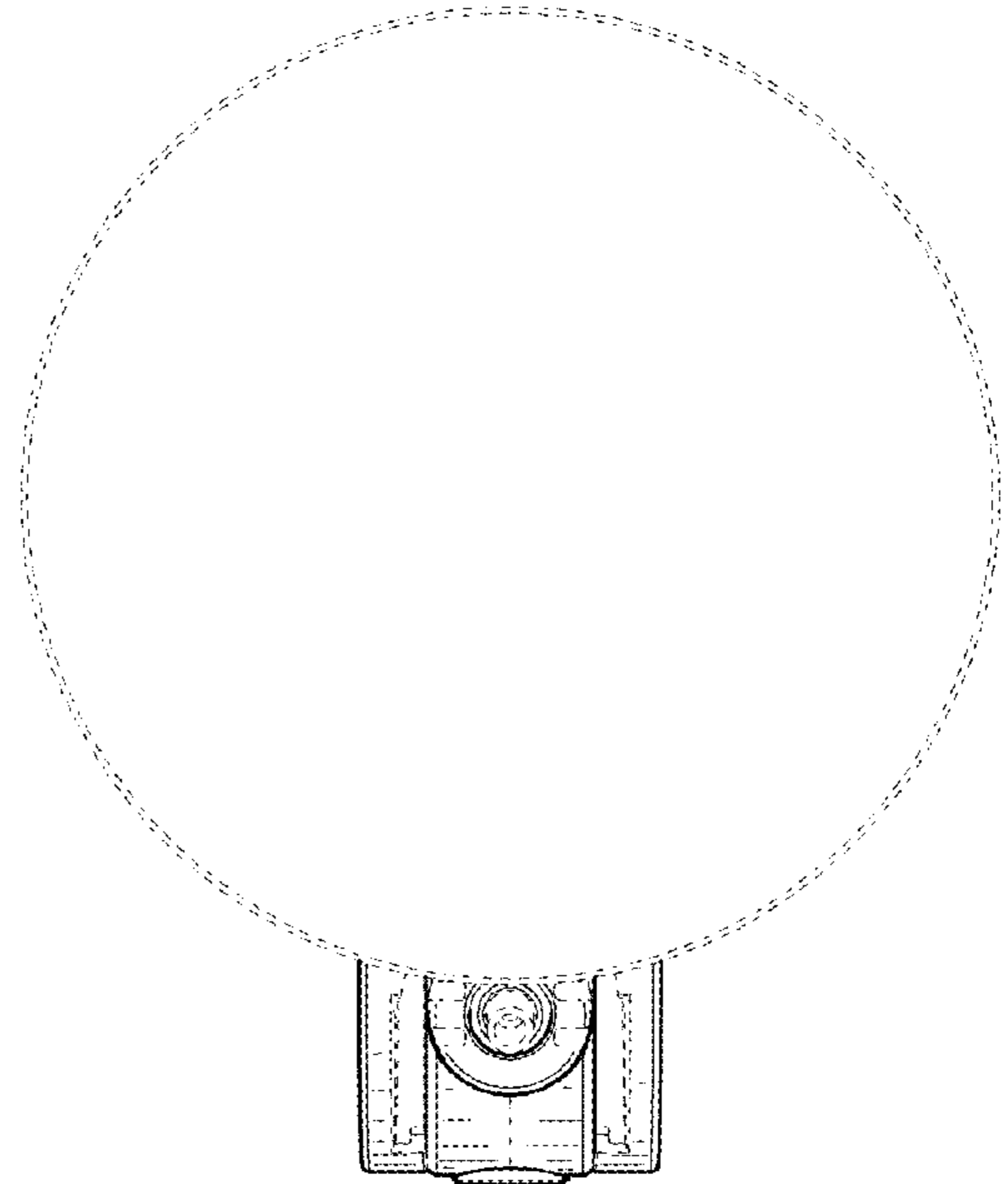

**Fig. 8**

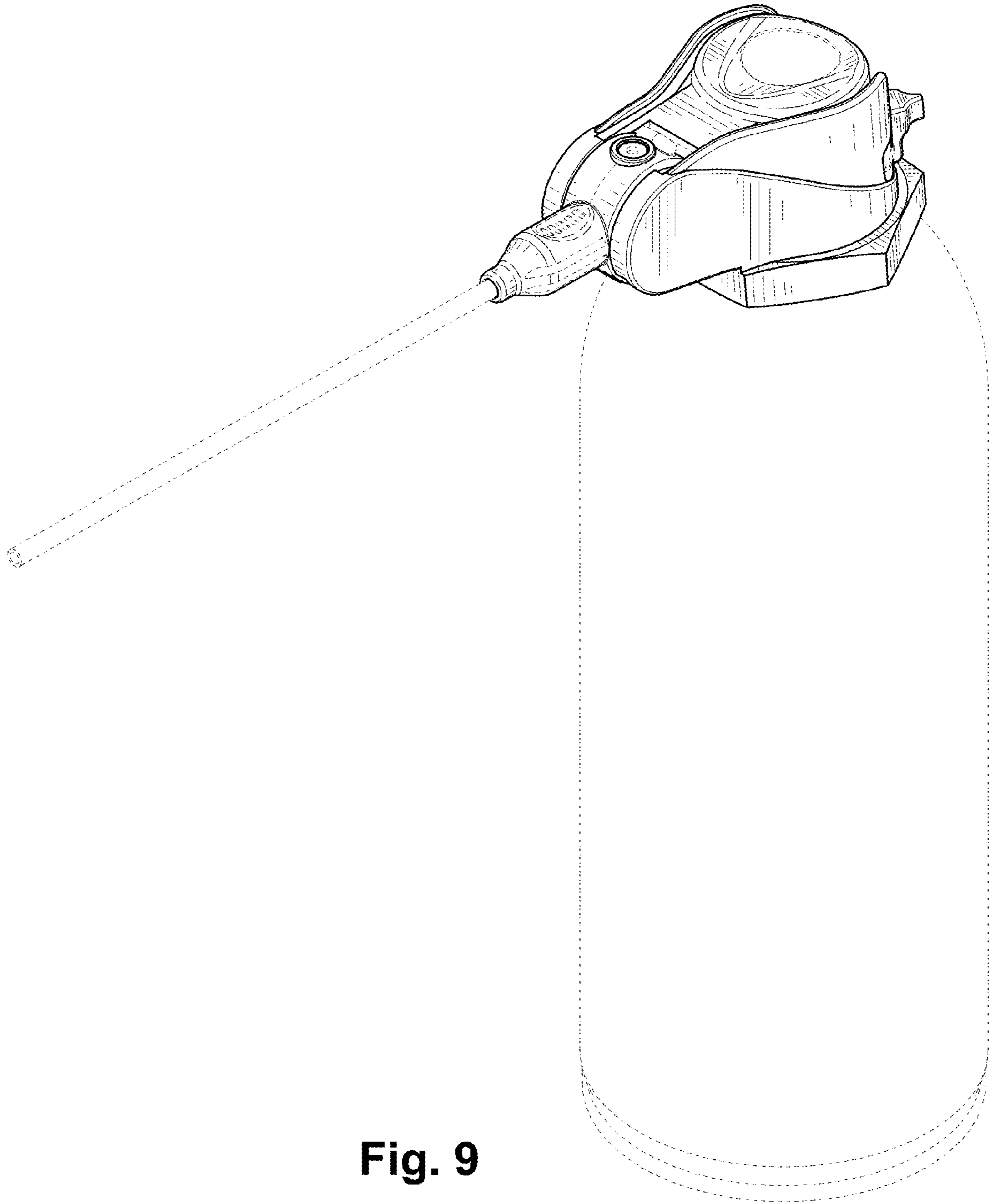

**Fig. 9**