

US00D929225S

(12) **United States Design Patent** (10) **Patent No.:** **US D929,225 S**
Schatz (45) **Date of Patent:** **** Aug. 31, 2021**

(54) **PACKAGING ORNAMENTATION**
(71) Applicant: **BSN Medical GmbH**, Hamburg (DE)
(72) Inventor: **Ole Schatz**, Hamburg (DE)
(**) Term: **15 Years**

D650,273 S * 12/2011 Tekulve D9/432
D651,896 S * 1/2012 Ren D9/434
D655,155 S * 3/2012 Tekulve D9/432
D660,145 S * 5/2012 Tekulve D9/432
D675,521 S * 2/2013 Gregory D9/434
D677,580 S * 3/2013 Powers D9/669

(Continued)

(21) Appl. No.: **35/001,726**
(22) Filed: **Aug. 14, 2019**

OTHER PUBLICATIONS

“Medical Solutions” [online], essity.com. [Retrieved on Jun. 19, 2021], Retrieved from the Internet: <<https://www.essity.com/company/essitys-business-and-operations-worldwide/personal-care/medical-solutions/medical-solutions/>>.*

(80) **Hague Agreement Data**
Int. Filing Date: **Aug. 14, 2019**
Int. Reg. No.: **DM/207652**
Int. Reg. Date: **Aug. 14, 2019**
Int. Reg. Pub. Date: **May 8, 2020**

Primary Examiner — Mojtaba Tehrani
(74) *Attorney, Agent, or Firm* — Shumaker, Loop & Kendrick, LLP

(30) **Foreign Application Priority Data**

(57) **CLAIM**

Feb. 14, 2019 (EM) 006253787

The ornamental design for a packaging ornamentation, as shown and described.

(51) **LOC (13) Cl.** **09-07**

(52) **U.S. Cl.**
USPC **D9/434**

(58) **Field of Classification Search**
USPC D9/414, 417, 418, 432, 433, 434, 452, D9/667
CPC B65D 75/14; B65D 75/36; B65D 75/527; B65D 75/54; B65D 5/20; B65D 5/00; B65D 5/02; B65D 5/18
See application file for complete search history.

DESCRIPTION

47.1-61.1 Packaging Ornamentation

- 47.1 : Front
- 48.1 : Front
- 49.1 : Front
- 50.1 : Front
- 51.1 : Front
- 52.1 : Front
- 53.1 : Front
- 54.1 : Front
- 55.1 : Front
- 56.1 : Front
- 57.1 : Front
- 58.1 : Front
- 59.1 : Front
- 60.1 : Front
- 61.1 : Front

(56) **References Cited**

U.S. PATENT DOCUMENTS

D567,080 S * 4/2008 Bone D9/432
D600,551 S * 9/2009 Bruno D9/434
D612,234 S * 3/2010 Westemeyer D9/434
D613,156 S * 4/2010 Francis D9/434
D613,157 S * 4/2010 Francis D9/434
D621,702 S * 8/2010 Tekulve D9/432
D636,680 S * 4/2011 Cocchioni D9/627
D640,140 S * 6/2011 Zhang D9/658
D649,874 S * 12/2011 Barclay D9/432

(Continued)

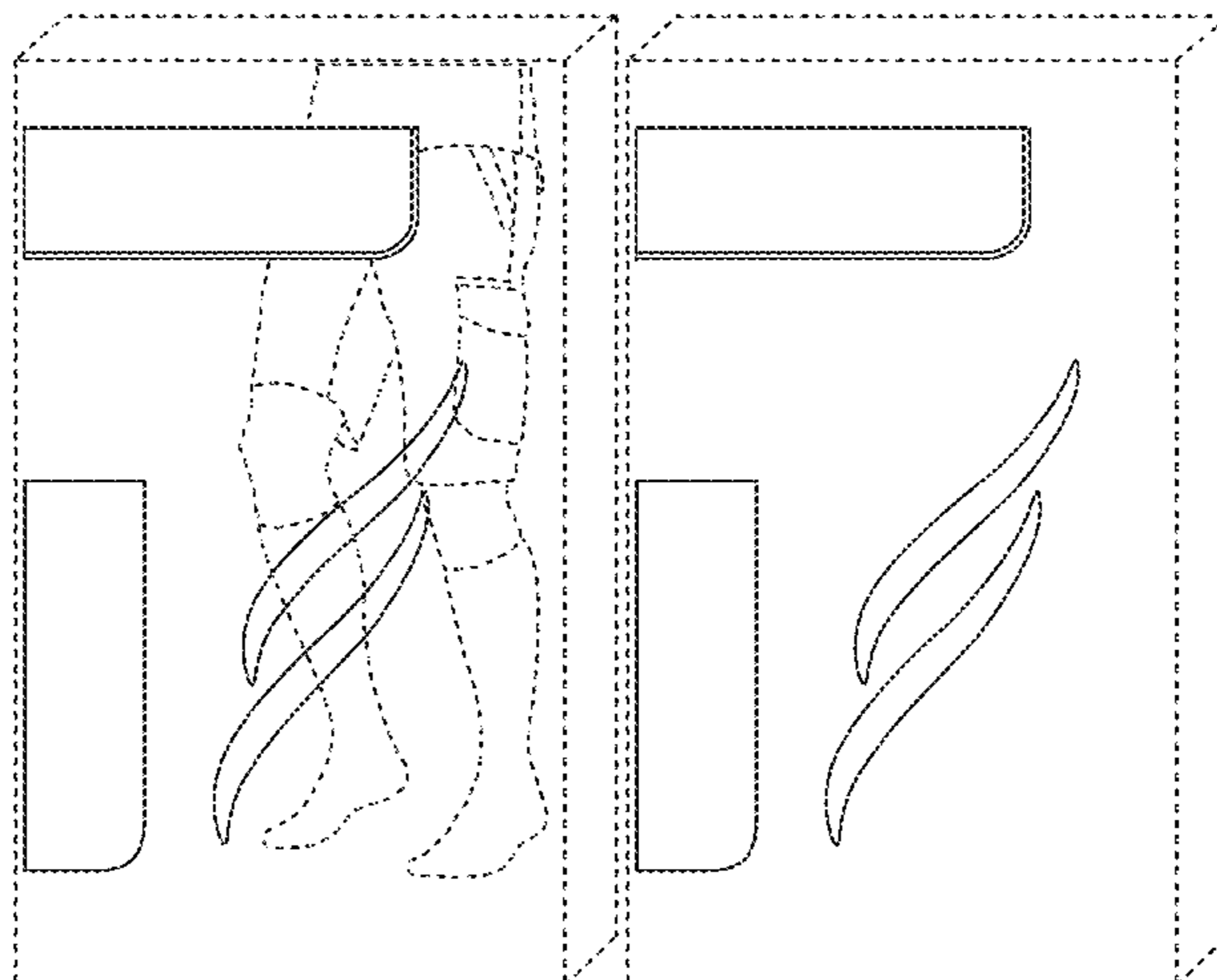

The evenly broken lines in the reproductions disclose unclaimed environment only and form no part of the claimed design.

1 Claim, 15 Drawing Sheets

(56) **References Cited**

U.S. PATENT DOCUMENTS

D684,467 S *	6/2013	Macaulay	D9/434
D684,468 S *	6/2013	Macaulay	D9/434
D686,504 S *	7/2013	Catalano	D9/627
D694,105 S *	11/2013	Zamudio Rodriguez	D9/432
D701,118 S *	3/2014	Klopp	D9/434
D706,629 S *	6/2014	Bartels	D9/434
D725,466 S *	3/2015	Giza	D9/434
D728,365 S *	5/2015	Bischoff	D9/434
D730,179 S *	5/2015	Bischoff	D9/434
D768,481 S *	10/2016	Gagliardo	D9/434
D775,964 S *	1/2017	Mochizuki	D9/600
D800,573 S *	10/2017	Mochizuki	D9/624
D811,880 S *	3/2018	Pohlman	D9/499
D829,546 S *	10/2018	Gagliardo	D9/434
D846,384 S *	4/2019	Borkovetz	D9/434
D920,101 S *	5/2021	Abel	D9/434

* cited by examiner

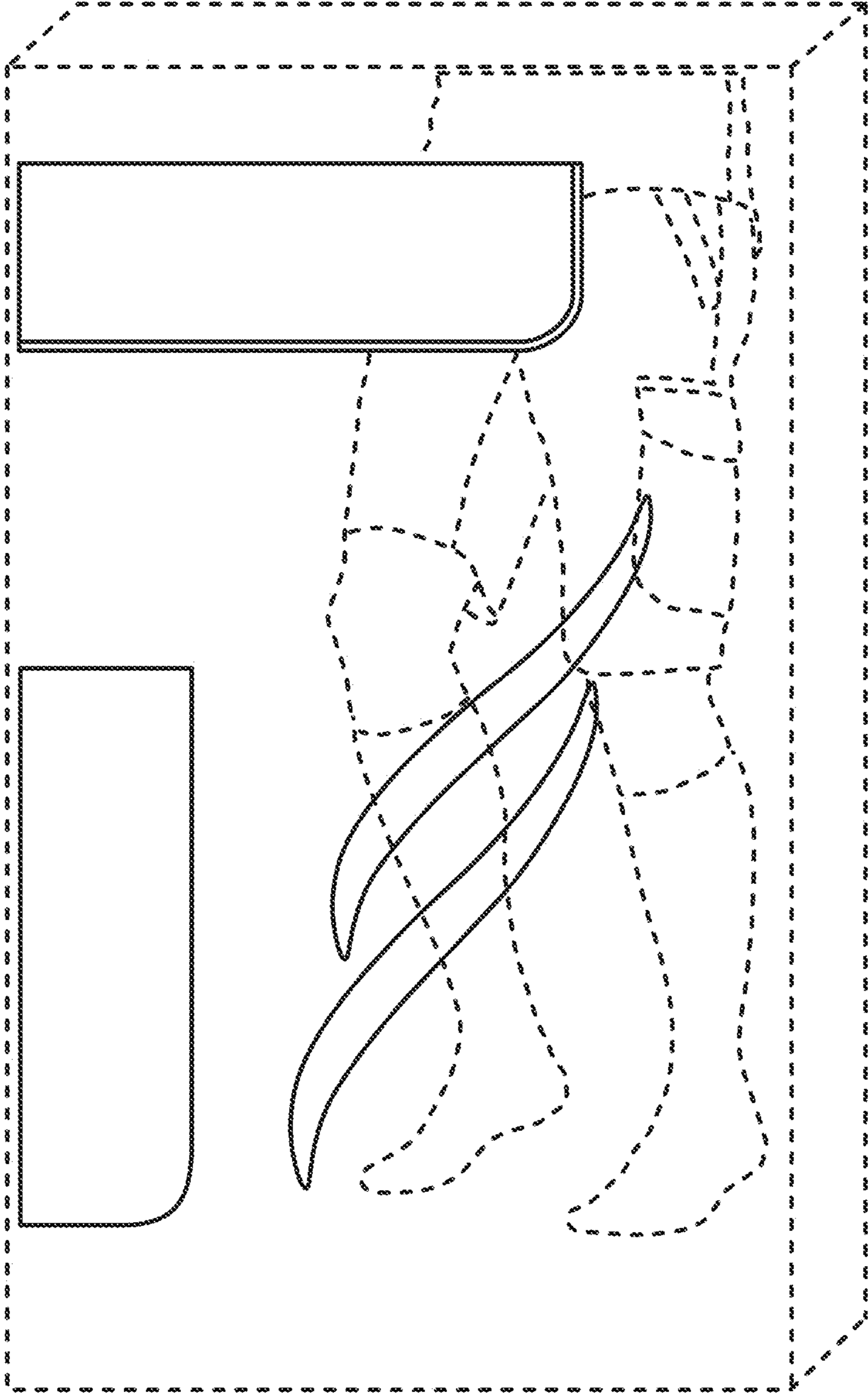

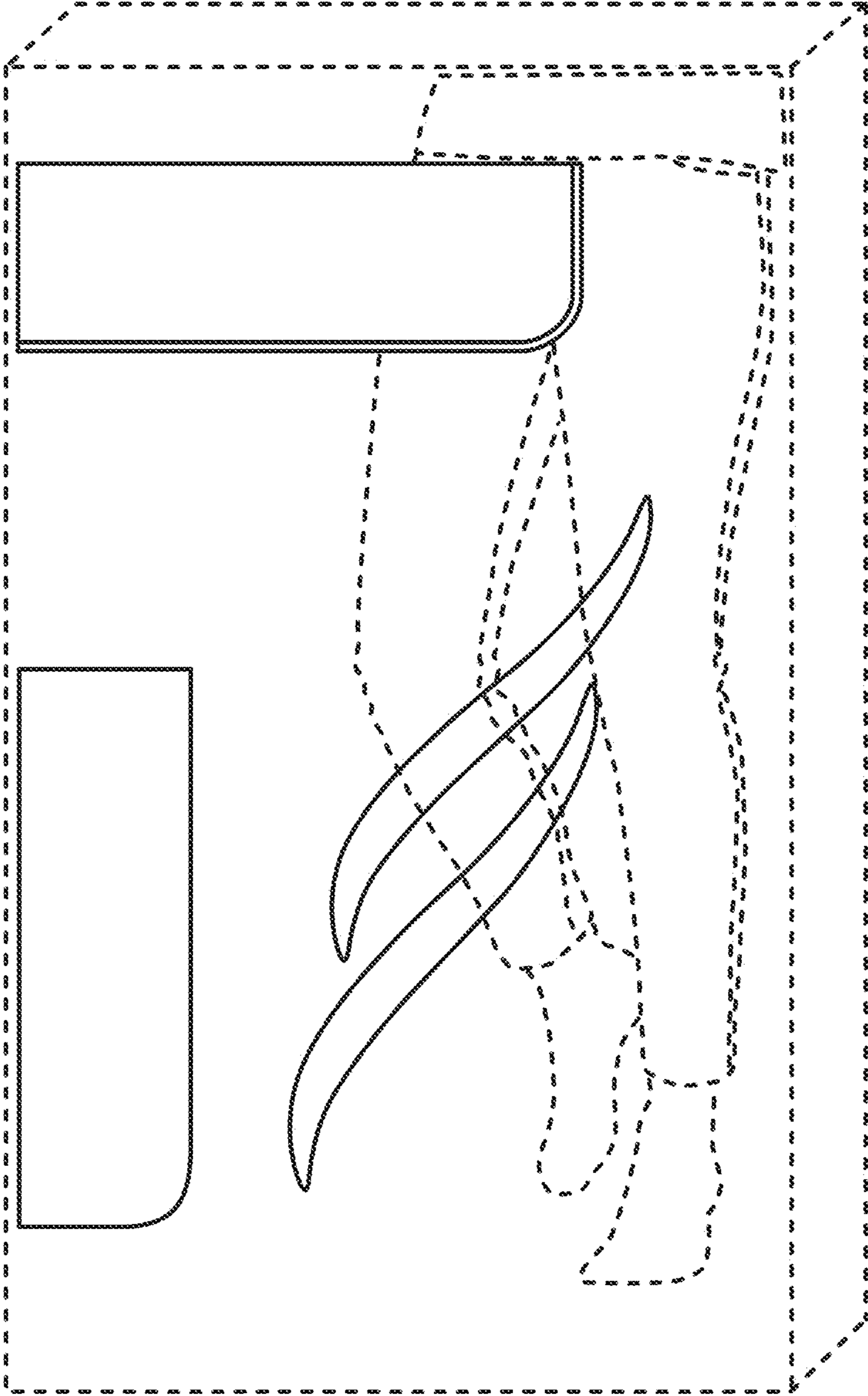

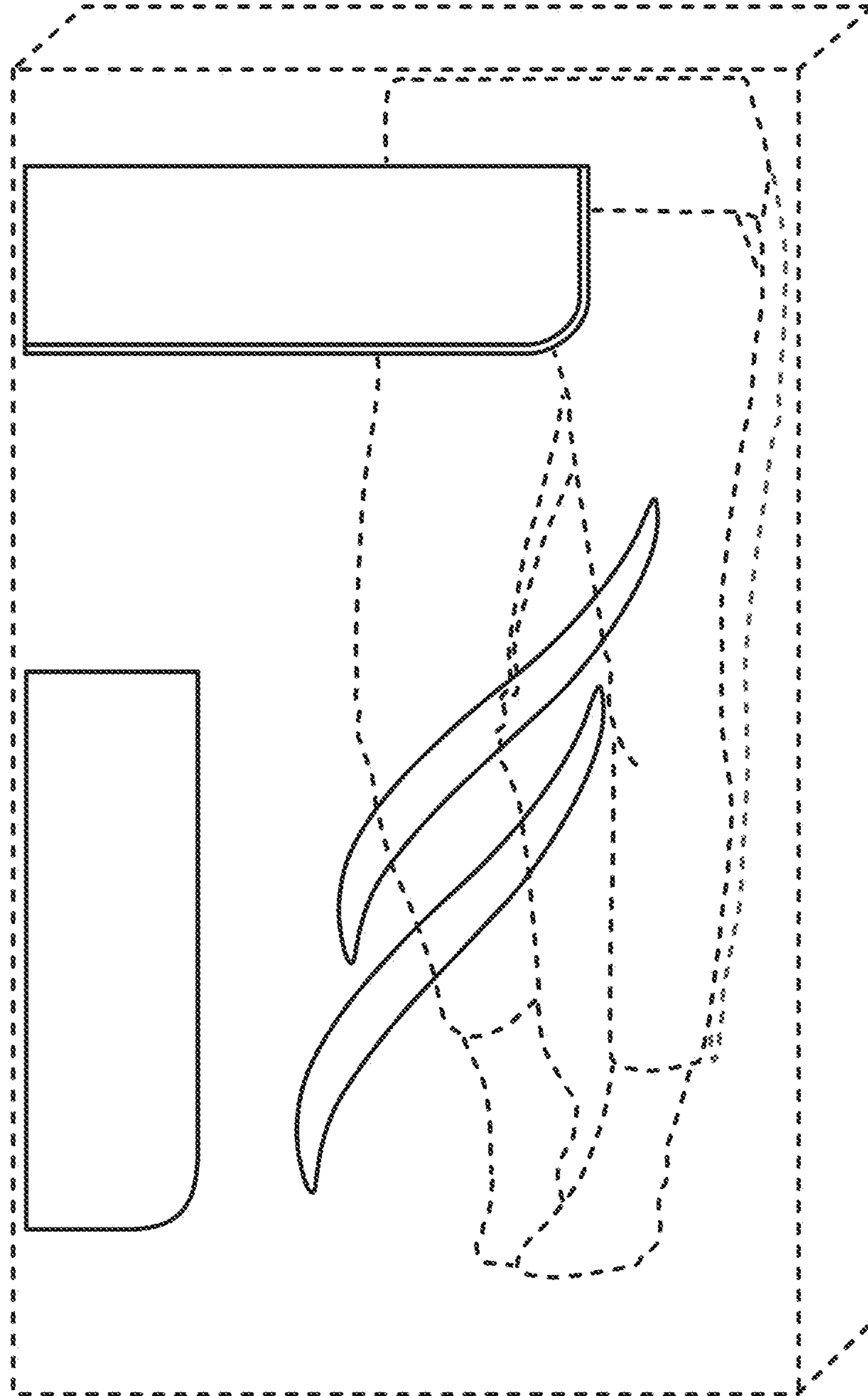

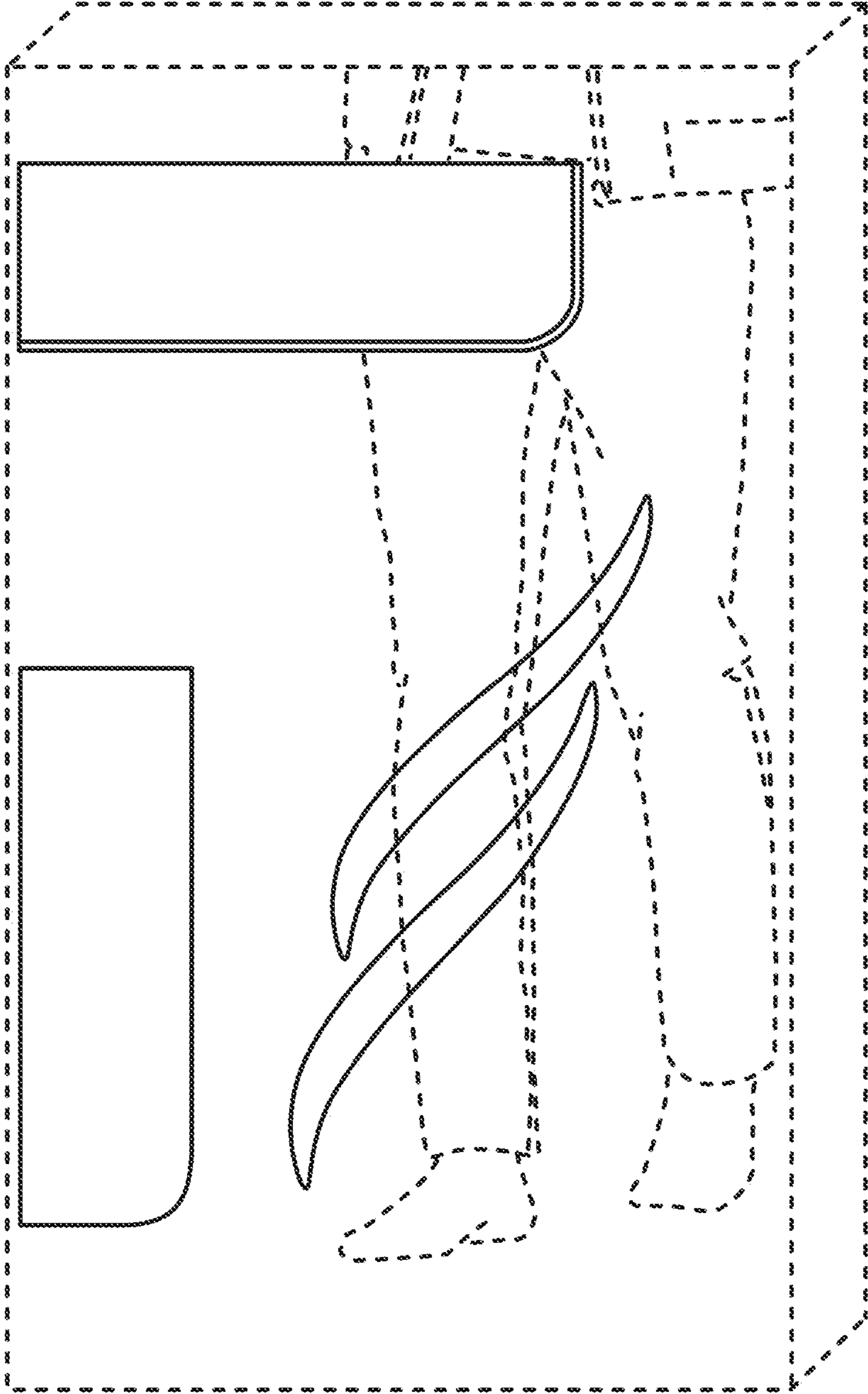

50.1

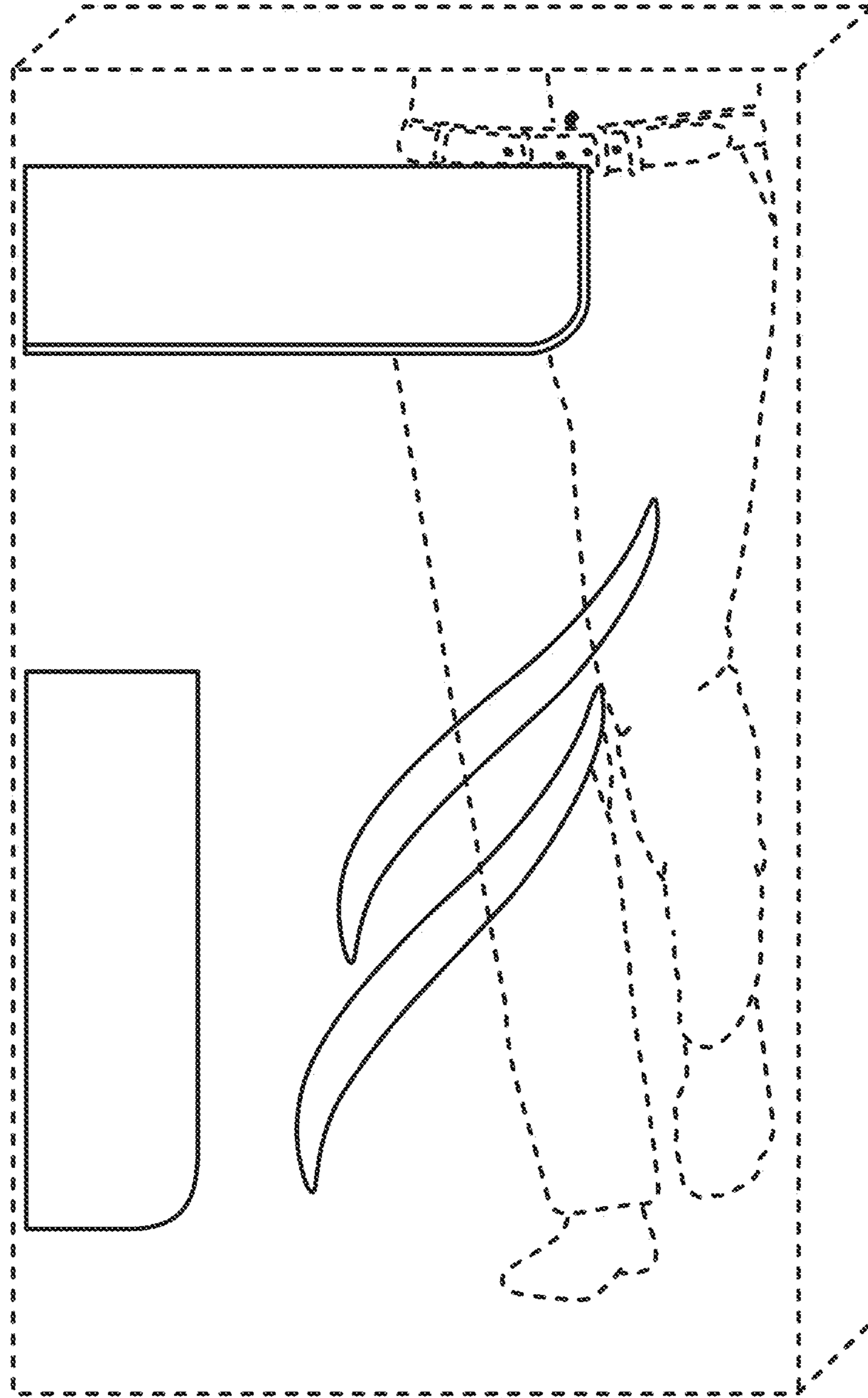

51.1

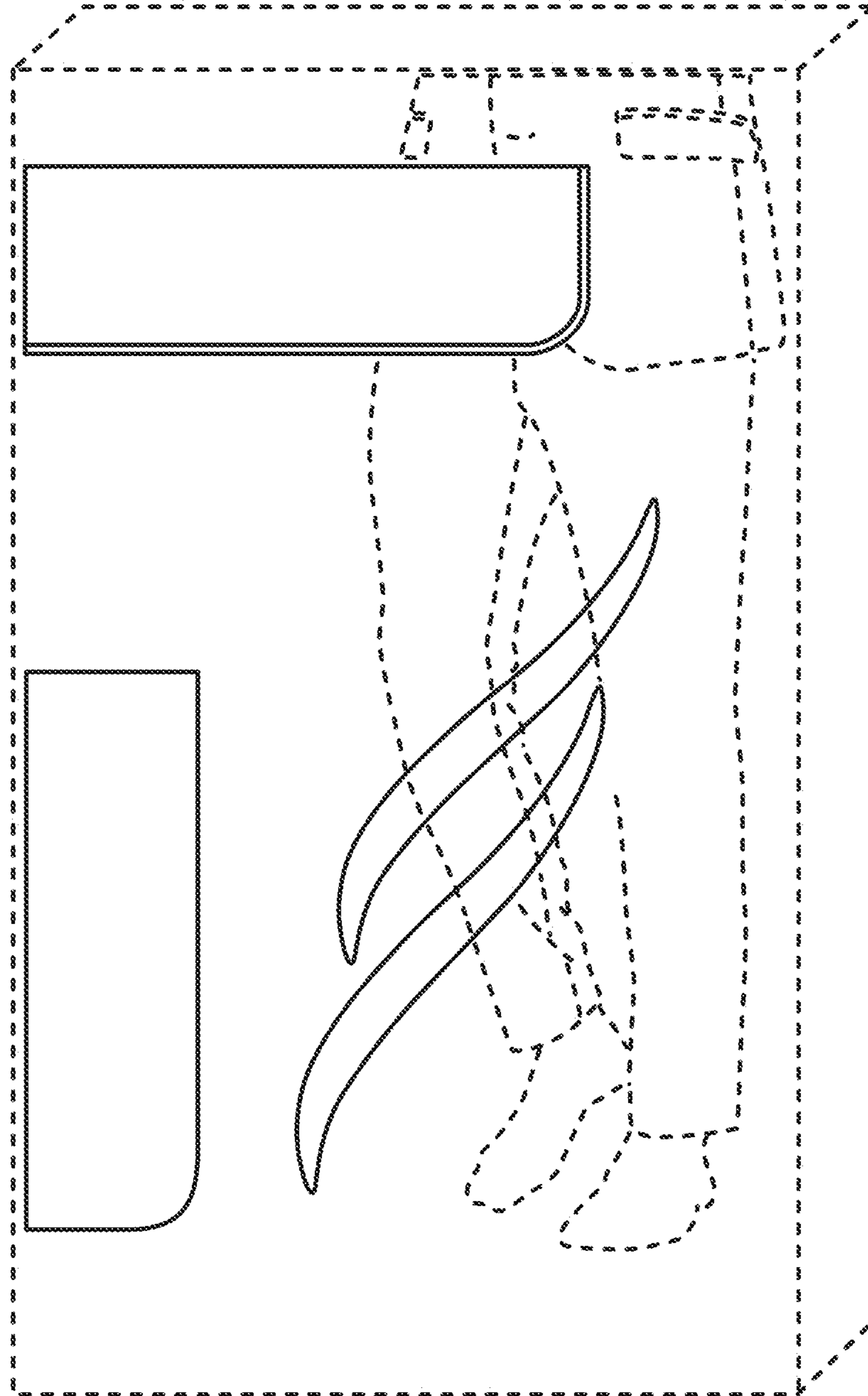

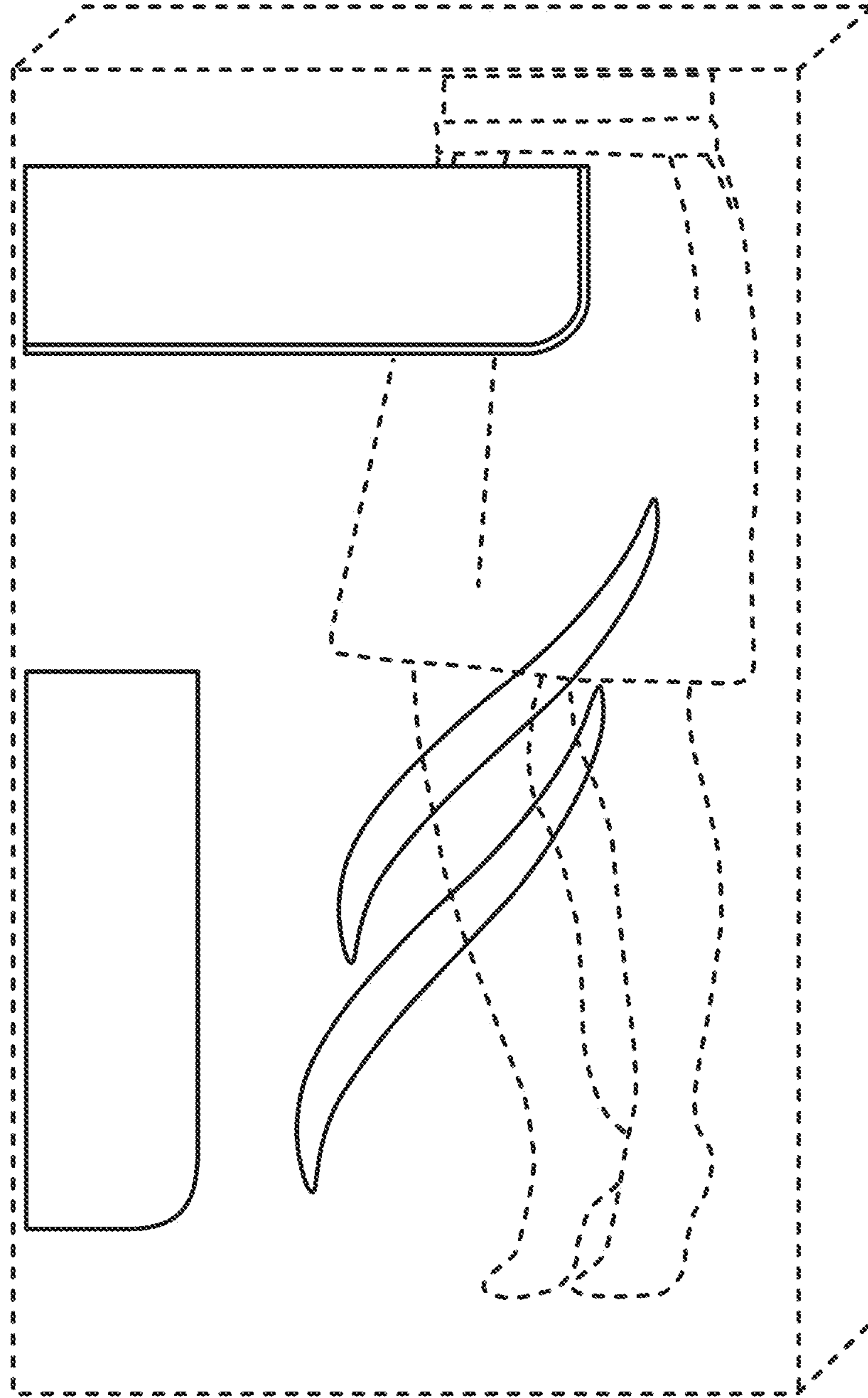

53.1

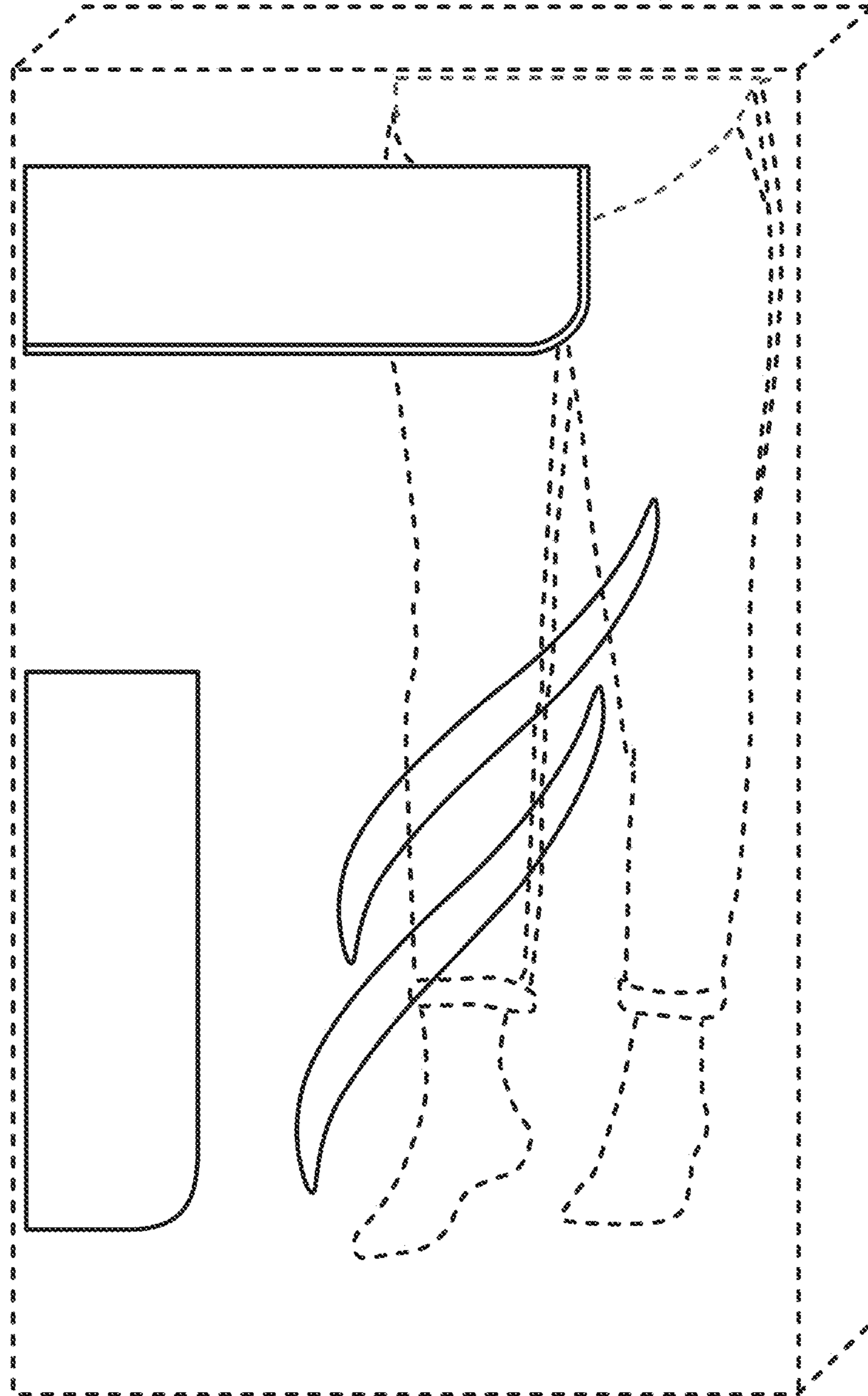

54.1

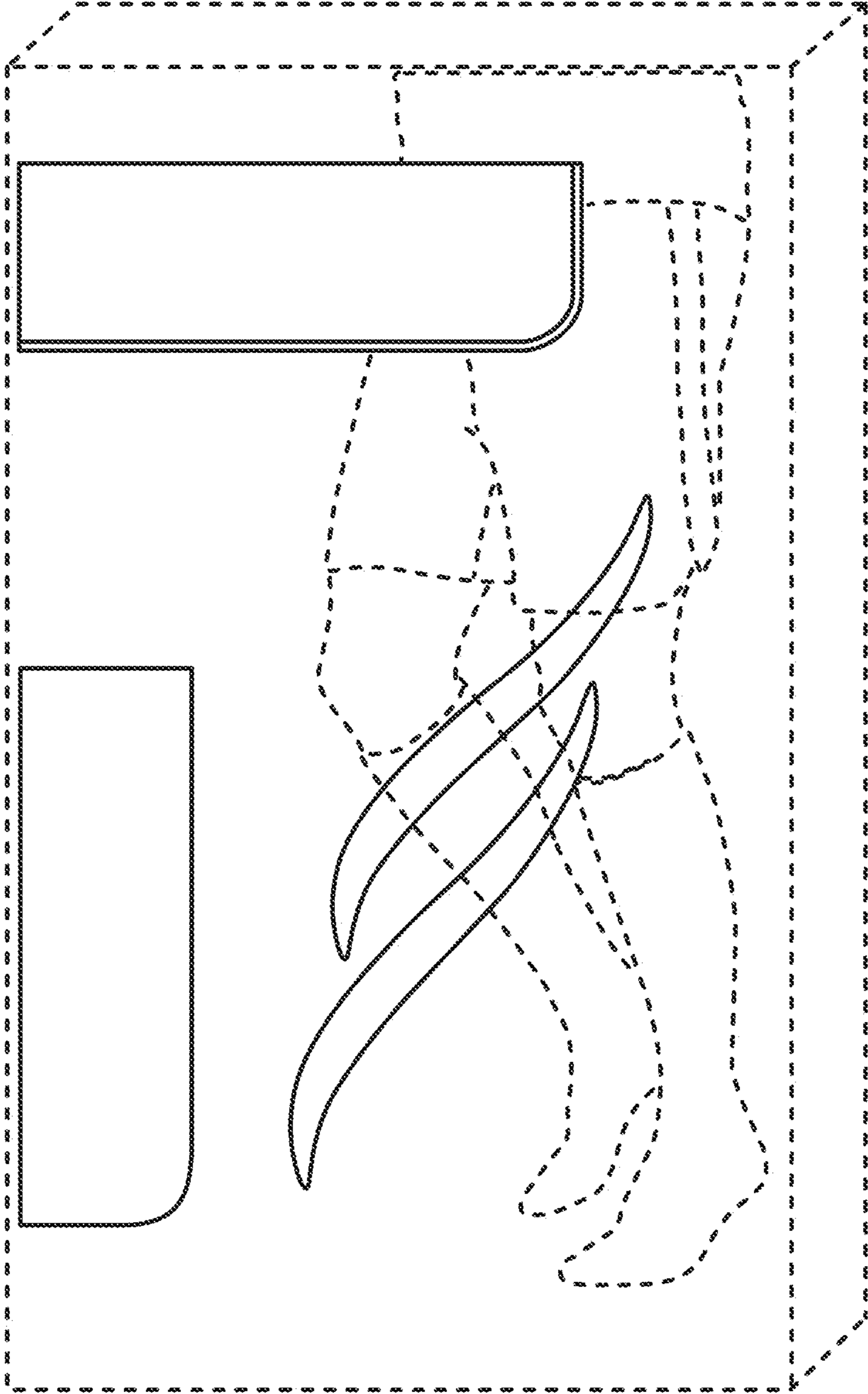

55.1

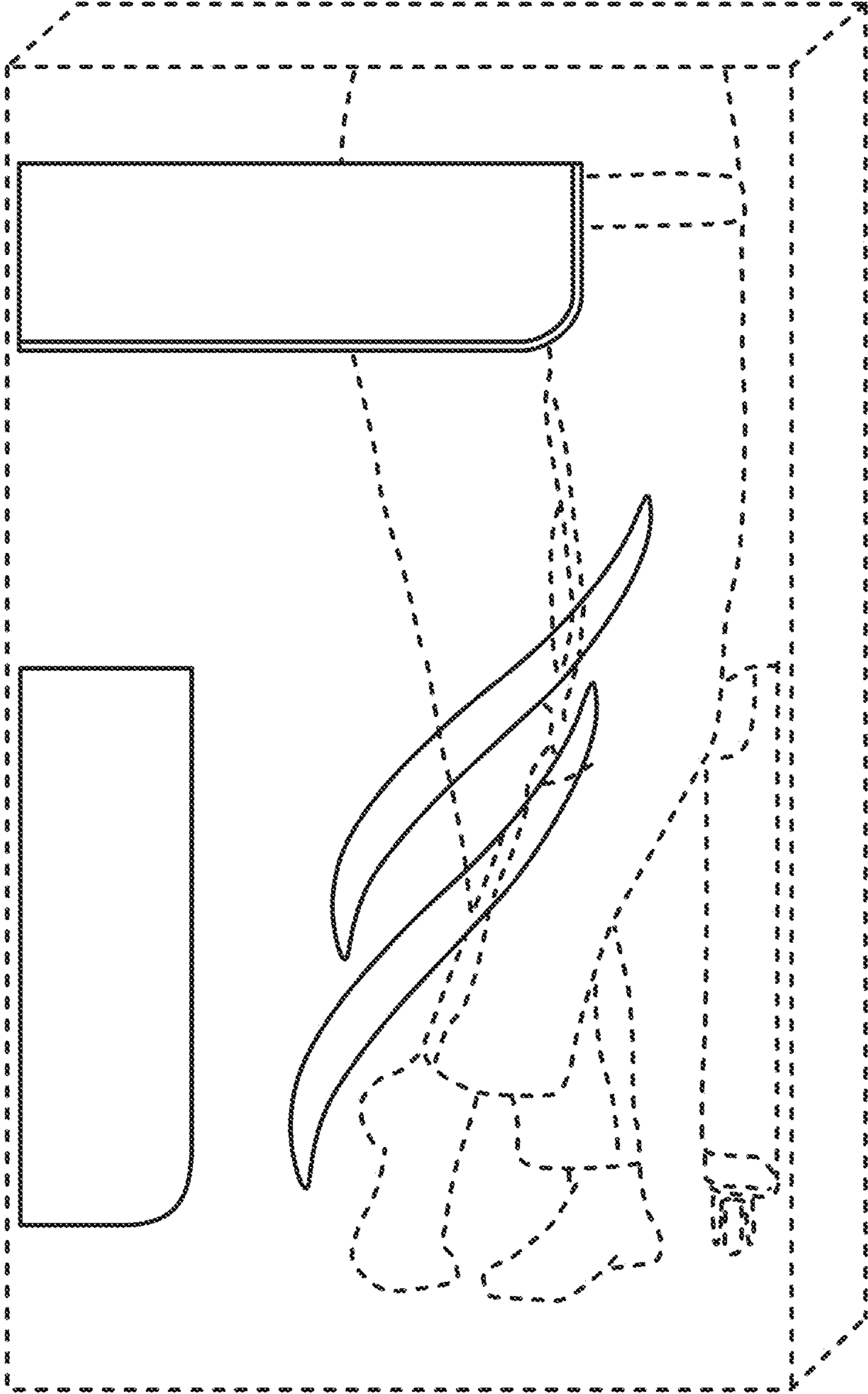

56.1

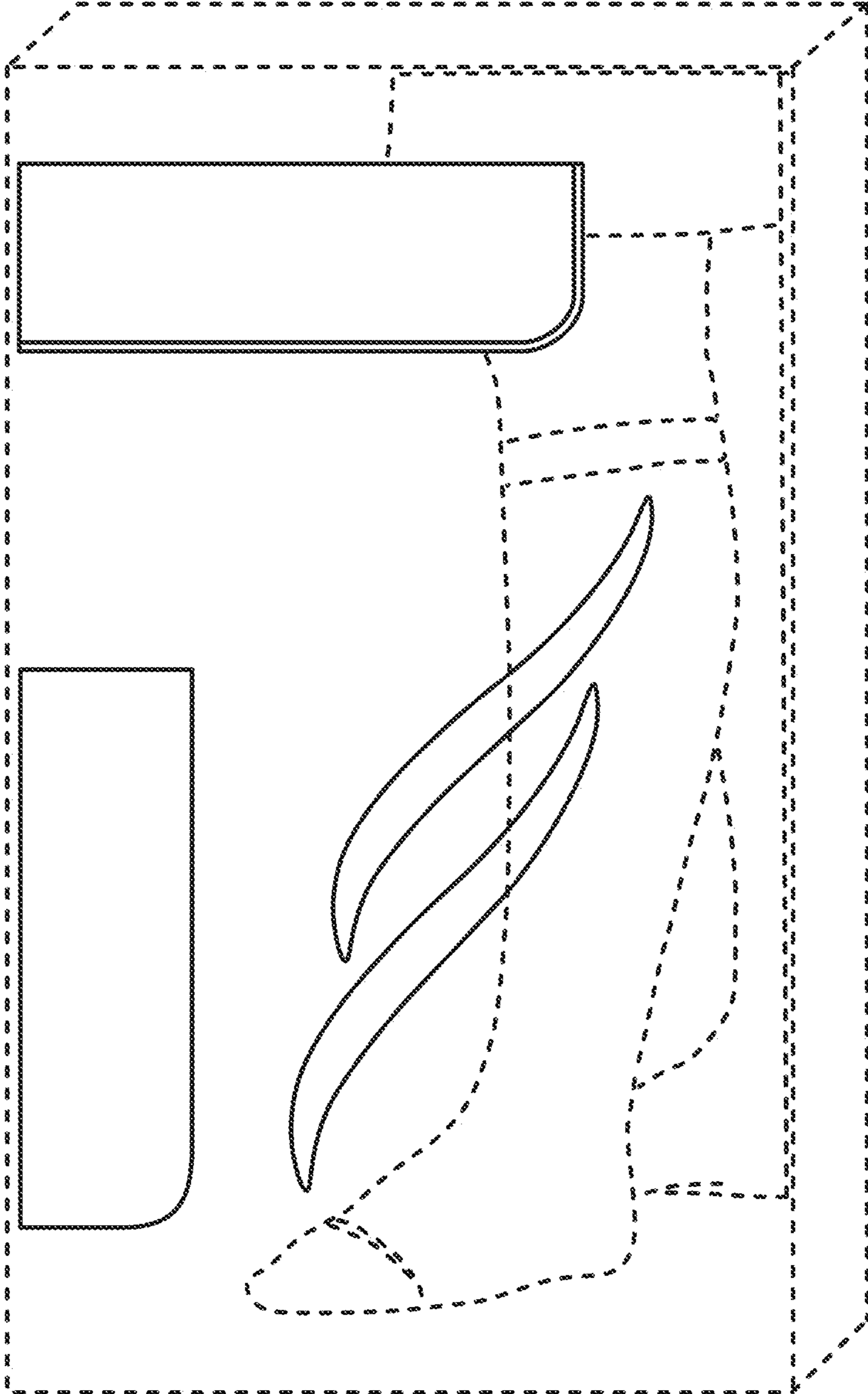

57.1

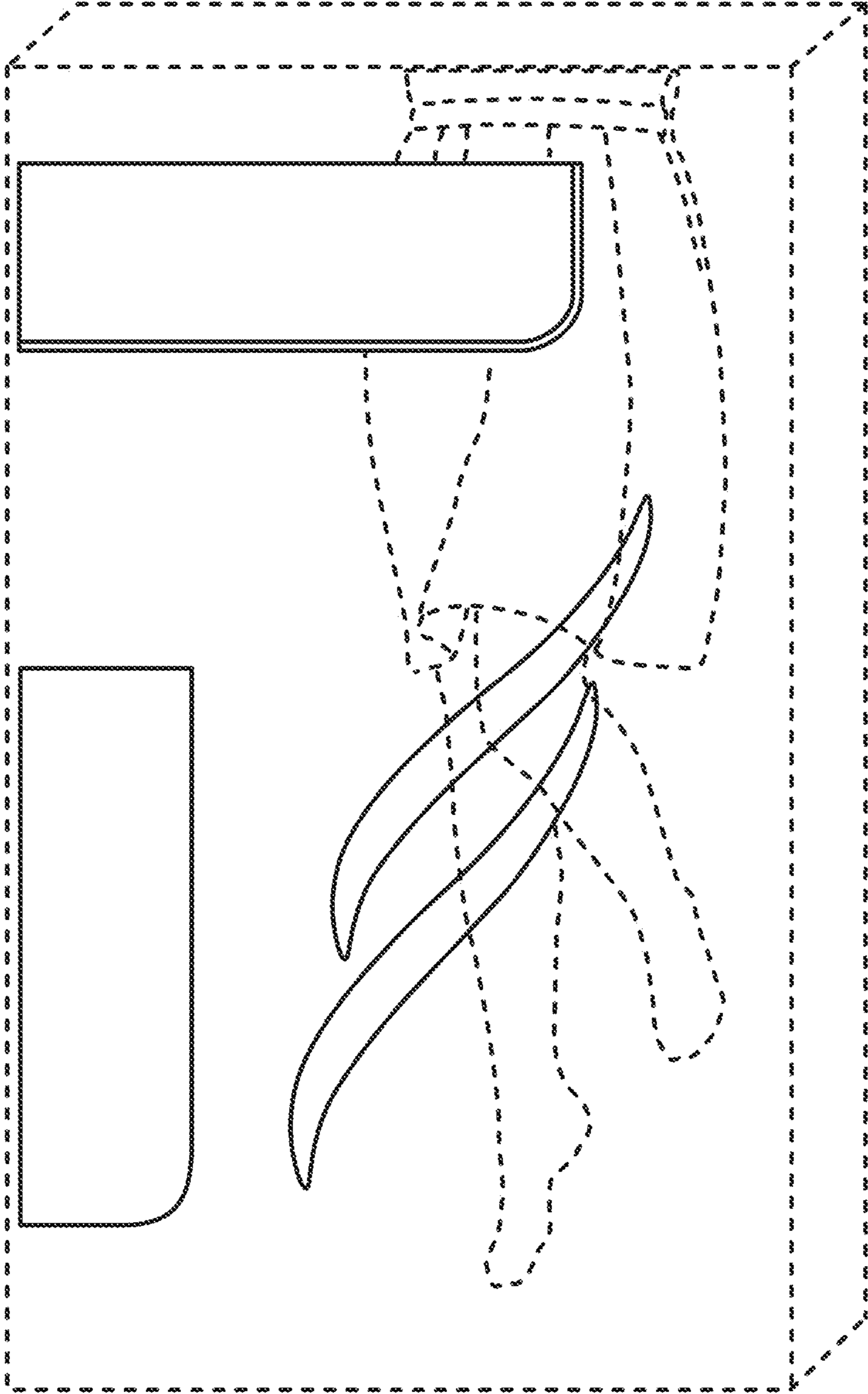

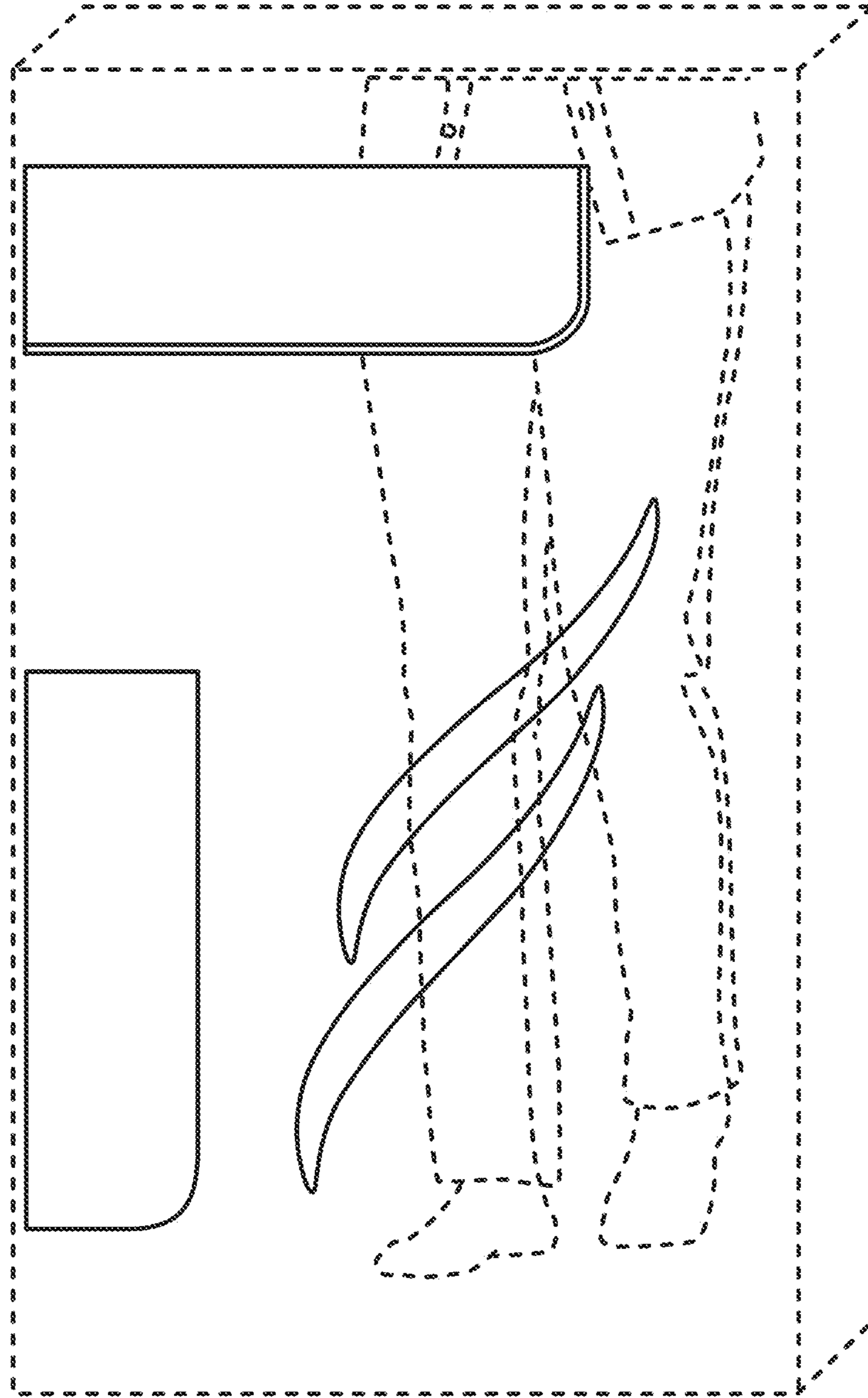

59.1

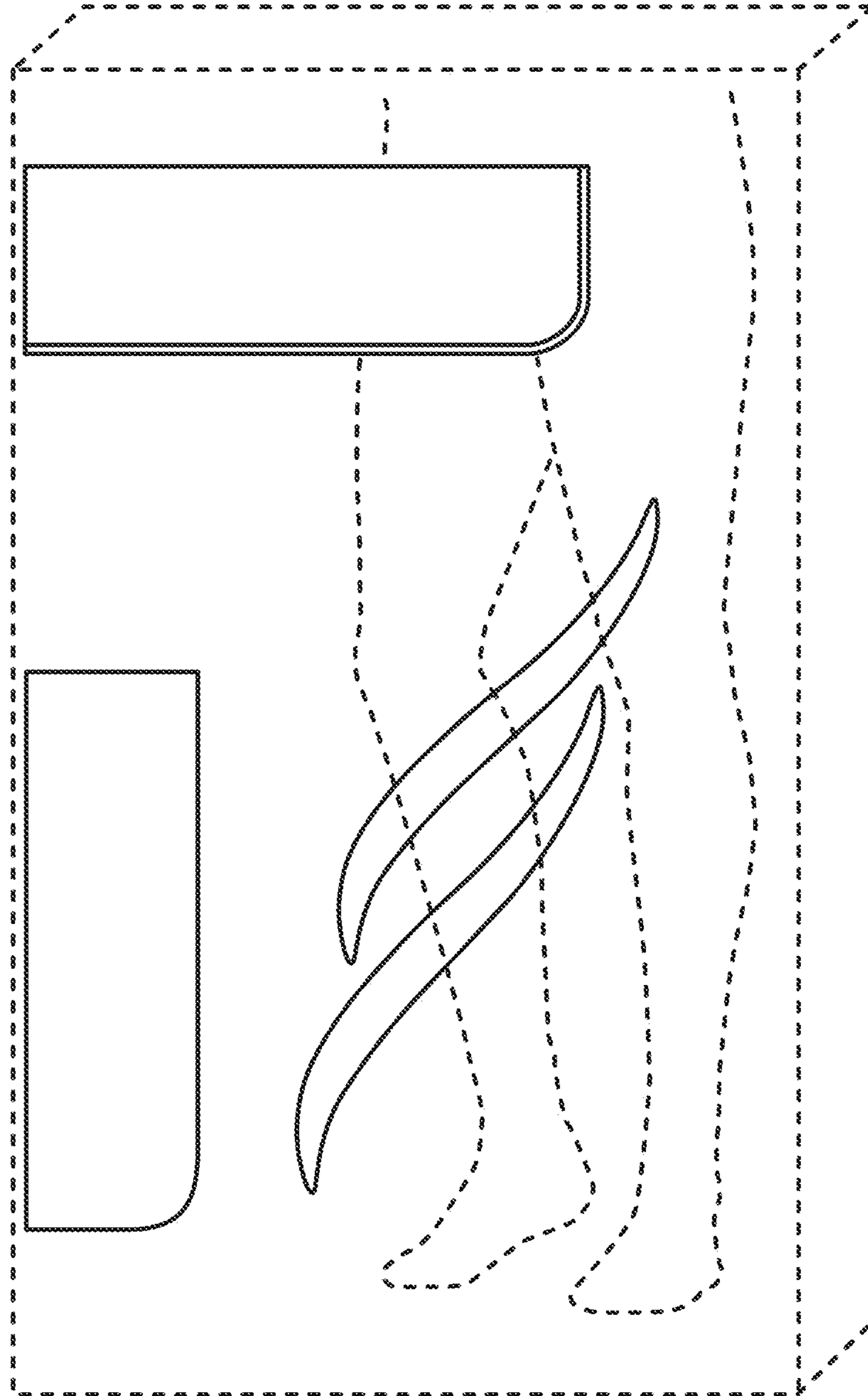

60.1

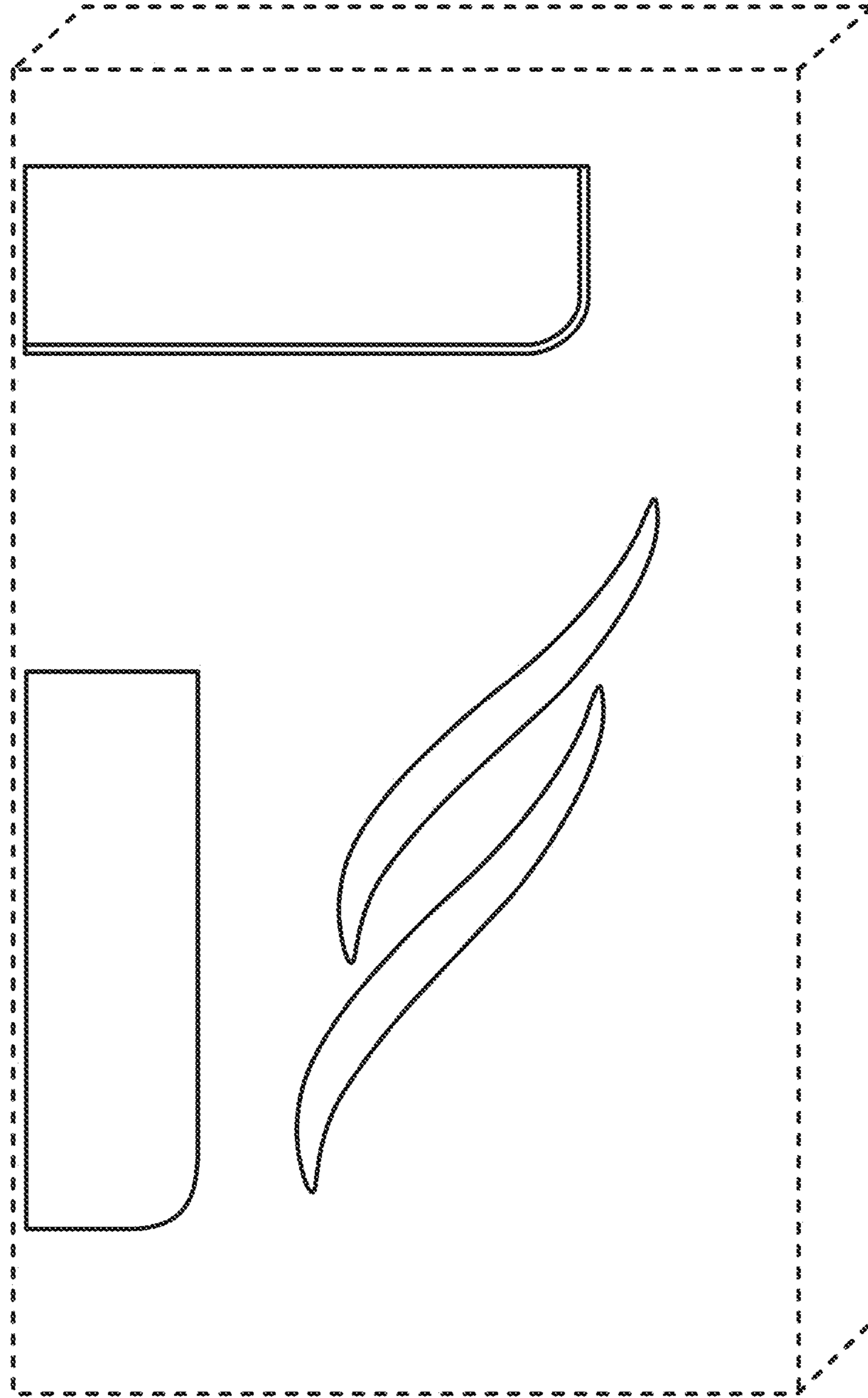

61.1