



US00D929216S

(12) **United States Design Patent** (10) **Patent No.:** **US D929,216 S**  
**Sutliff, II** (45) **Date of Patent:** **\*\* Aug. 31, 2021**

(54) **TARP ANCHOR** 4,541,148 A \* 9/1985 Watanabe ..... A44B 1/08  
24/102 PL  
(71) Applicant: **Charles Weiss Sutliff, II**, Kila, MT D288,162 S \* 2/1987 Hutton ..... D11/212  
(US) 4,688,304 A \* 8/1987 Marcott ..... A47K 10/12  
135/119  
(72) Inventor: **Charles Weiss Sutliff, II**, Kila, MT 4,897,007 A \* 1/1990 Chen ..... F16B 15/06  
(US) 5,074,014 A \* 12/1991 Freeman ..... E04H 15/64  
24/714.6  
(\*\*) Term: **15 Years** D324,649 S \* 3/1992 Lederhaus, Jr. .... D8/391  
D329,192 S ‡ 9/1992 Susac ..... D8/349  
(21) Appl. No.: **29/772,401** 5,168,605 A \* 12/1992 Bartlett ..... A47C 21/022  
24/129 R  
(22) Filed: **Mar. 1, 2021** (Continued)

**Related U.S. Application Data**

(63) Continuation-in-part of application No. 29/647,377,  
filed on May 11, 2018, now Pat. No. Des. 911,831.  
(51) **LOC (13) Cl.** ..... **08-08**  
(52) **U.S. Cl.**  
USPC ..... **D8/394**  
(58) **Field of Classification Search**  
USPC ..... D8/382, 383, 394, 395, 499; D11/200,  
D11/212, 215, 218; D19/65; D21/839  
CPC .. F16B 1/00; F16B 2001/0028; H01F 7/0263;  
A44B 99/005; A44B 1/32; A44B 13/00;  
A44B 11/20; Y10T 24/21; Y10T  
24/44034; Y10T 24/44043  
See application file for complete search history.

**References Cited**

(56) **U.S. PATENT DOCUMENTS**  
1,487,355 A \* 3/1924 Overmyer ..... E05B 1/0015  
16/417  
2,939,195 A \* 6/1960 Carlson ..... F16B 2/248  
24/459  
3,780,400 A ‡ 12/1973 Hinsperger ..... A44B 1/185  
24/16 P  
3,936,912 A \* 2/1976 Flanagan, Jr. .... E04H 15/64  
24/459  
D278,594 S \* 4/1985 Lye ..... D8/25

**OTHER PUBLICATIONS**

“Anchor Point,” <<http://usaprogrip.com/products/ratchets-3-2/bar-handle-2-2/>>, 1 page, retrieved on Apr. 27, 2018, <http://usaprogrip.com/products/ratchets-3-2/bar-handle-2-2/>. ‡  
(Continued)

*Primary Examiner* — Steven J Czyz  
(74) *Attorney, Agent, or Firm* — Sarah J. Rhoades

(57) **CLAIM**

The ornamental design for a tarp anchor, as shown and described.

**DESCRIPTION**

FIG. 1 is a top perspective view of a tarp anchor;  
FIG. 2 is a front view of FIG. 1;  
FIG. 3 is a rear view of FIG. 1;  
FIG. 4 is a first side view of FIG. 1;  
FIG. 5 is a second side view of FIG. 1;  
FIG. 6 is a top view top view of FIG. 1; and,  
FIG. 7 is a bottom view of FIG. 1.  
The broken lines depict portions of the article that form no part of the claimed design.

**1 Claim, 4 Drawing Sheets**

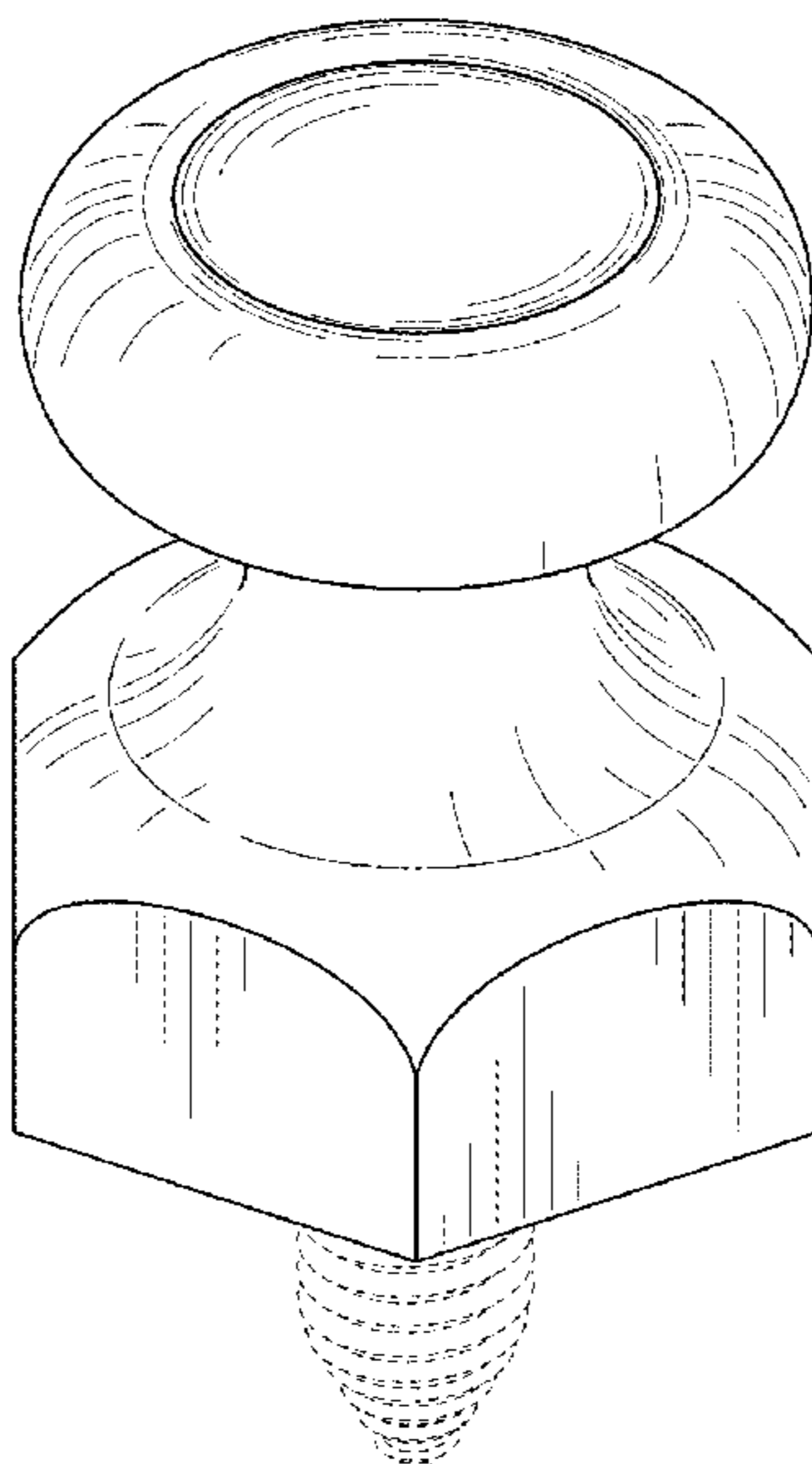

(56)

References Cited

U.S. PATENT DOCUMENTS

D333,085 S ‡ 2/1993 Thomsen ..... D8/349  
 D337,255 S \* 7/1993 Novelli, Sr. .... D30/155  
 D339,521 S \* 9/1993 Bartlett ..... D11/212  
 D340,007 S \* 10/1993 Gershenson ..... D11/200  
 5,274,885 A ‡ 1/1994 Hellweg ..... A45F 5/02  
 224/272  
 5,353,441 A ‡ 10/1994 Lazorchak ..... A47D 27/085  
 2/240  
 D361,671 S \* 8/1995 Sharpe ..... D6/323  
 D362,176 S \* 9/1995 Solbeck ..... D8/382  
 5,499,427 A \* 3/1996 Bowman ..... A47B 95/02  
 16/417  
 D375,248 S ‡ 11/1996 Bryant ..... D8/344  
 D393,417 S \* 4/1998 Glickman ..... D8/382  
 D398,451 S \* 9/1998 Sharpe ..... D6/323  
 D409,663 S \* 5/1999 Wagner ..... F16B 5/0657  
 D19/65  
 D414,207 S \* 9/1999 Wagner ..... F16B 11/006  
 D19/65  
 D428,058 S \* 7/2000 Wagner ..... D19/65  
 6,132,060 A \* 10/2000 Gallo ..... B43M 15/00  
 362/190  
 6,199,247 B1 \* 3/2001 Tsai ..... A47K 10/14  
 24/343  
 6,273,656 B1 \* 8/2001 Cleland ..... F16B 19/1081  
 411/45  
 6,283,348 B1 ‡ 9/2001 Wang ..... A45F 5/02  
 224/197  
 6,292,987 B1 ‡ 9/2001 Combes ..... B60J 7/104  
 24/460  
 D454,591 S \* 3/2002 Vidmar ..... D19/65  
 D465,525 S ‡ 11/2002 Dilday ..... B42F 1/06  
 D19/65  
 6,484,370 B2 \* 11/2002 Kanie ..... B60R 13/0206  
 24/297  
 D466,937 S \* 12/2002 Kochlefl ..... E04H 15/64  
 D19/65  
 6,719,513 B1 \* 4/2004 Moutousis ..... F16B 21/084  
 411/510  
 D506,121 S ‡ 6/2005 Falconer ..... D12/162  
 D507,306 S \* 7/2005 Siegel ..... D19/65  
 D508,533 S \* 8/2005 Siegel ..... D19/65  
 D509,471 S ‡ 9/2005 Cronce ..... D12/414  
 6,978,522 B2 ‡ 12/2005 Liao ..... F16B 5/0692  
 24/459  
 7,178,855 B2 ‡ 2/2007 Catron ..... B60J 5/0468  
 24/297  
 D552,691 S ‡ 10/2007 Tak ..... D21/480  
 D562,124 S ‡ 2/2008 Hargis ..... D8/394  
 D571,278 S \* 6/2008 Carnevali ..... D12/223  
 D572,117 S ‡ 7/2008 Daun ..... D8/354  
 D574,700 S \* 8/2008 Bevirt ..... D8/382  
 7,406,753 B2 ‡ 8/2008 LaScala ..... E04H 15/64  
 24/460  
 D588,902 S \* 3/2009 Carnevali ..... D8/354  
 D623,506 S \* 9/2010 Ghatikar ..... D8/382  
 D639,633 S \* 6/2011 Bishop ..... D8/312  
 D641,476 S \* 7/2011 Sibhatu ..... D24/156  
 D642,890 S \* 8/2011 Roe ..... D8/310  
 D645,723 S \* 9/2011 Roe ..... D8/307  
 D658,036 S ‡ 4/2012 Fong ..... D8/339  
 D662,392 S ‡ 6/2012 Main ..... D8/331  
 D674,273 S \* 1/2013 Yogev ..... D8/382  
 D679,170 S ‡ 4/2013 Else ..... D8/349

8,490,257 B2 \* 7/2013 Cameron ..... A44B 1/04  
 24/674  
 8,650,725 B1 \* 2/2014 Cooper ..... E04H 15/64  
 24/459  
 8,752,803 B2 \* 6/2014 Goldberg ..... B43M 15/00  
 248/490  
 D729,041 S ‡ 5/2015 Smith ..... D8/349  
 D748,461 S ‡ 2/2016 Catchings ..... D8/394  
 9,249,814 B2 ‡ 2/2016 Tsai ..... A45F 5/004  
 D751,889 S ‡ 3/2016 Thiltges ..... D8/394  
 D767,957 S ‡ 10/2016 Hancock ..... D8/44  
 D768,468 S \* 10/2016 Maloney ..... D8/382  
 D768,472 S \* 10/2016 Yoshihashi ..... D8/382  
 D773,339 S ‡ 12/2016 McClure ..... D11/200  
 D774,380 S \* 12/2016 Apter ..... D8/349  
 9,516,931 B2 \* 12/2016 Mencagli ..... A44B 1/32  
 9,610,904 B2 \* 4/2017 Huelke ..... B60R 13/0206  
 D799,938 S \* 10/2017 Lowitz ..... D8/354  
 9,777,756 B2 ‡ 10/2017 Oakes ..... F16B 1/00  
 9,874,039 B2 \* 1/2018 Haas ..... E04H 15/64  
 D813,720 S ‡ 3/2018 Fantauzzo ..... D11/200  
 D815,516 S \* 4/2018 Karmarkar ..... D8/382  
 9,961,966 B2 \* 5/2018 Ryan ..... A44B 1/32  
 D819,428 S \* 6/2018 Ng ..... D8/354  
 D835,506 S \* 12/2018 Evans ..... D9/439  
 D840,013 S \* 2/2019 Zhang ..... D23/366  
 10,327,438 B2 \* 6/2019 Heegaard ..... F16B 1/00  
 10,328,776 B2 ‡ 6/2019 Tortorella, Jr. .... B60J 7/104  
 10,371,183 B2 ‡ 8/2019 Moreau ..... F16B 2/185  
 10,400,949 B1 ‡ 9/2019 Kozak ..... F16M 13/02  
 10,495,126 B2 \* 12/2019 Bejin ..... F16L 3/137  
 D874,252 S ‡ 2/2020 Eremita ..... D8/394  
 D874,254 S ‡ 2/2020 Eremita ..... D8/394  
 10,602,806 B2 \* 3/2020 Dagostino ..... A44B 1/32  
 D882,384 S \* 4/2020 Bastian ..... D8/382  
 D886,872 S \* 6/2020 Myers ..... D15/7  
 D891,235 S \* 7/2020 Liebelt ..... D8/382  
 D893,987 S \* 8/2020 Cook ..... D8/382  
 10,733,917 B2 \* 8/2020 Davison ..... F16B 11/006  
 D910,426 S \* 2/2021 Wang ..... D8/382  
 D911,831 S \* 3/2021 Sutliff, II ..... D8/394  
 2001/0042273 A1 ‡ 11/2001 Chaffee ..... A44B 11/2584  
 5/655.3  
 2004/0083583 A1 \* 5/2004 Bradley ..... F16B 5/0657  
 24/297  
 2004/0159208 A1 ‡ 8/2004 Yasunori ..... G10G 5/005  
 84/329  
 2005/0198791 A1 ‡ 9/2005 Liao ..... F16B 5/0692  
 24/459  
 2007/0099469 A1 \* 5/2007 Sorensen ..... A45F 5/02  
 439/289  
 2008/0209698 A1 ‡ 9/2008 Colorado ..... A45F 5/02  
 24/595.1  
 2010/0199467 A1 ‡ 8/2010 Morejon ..... A47D 15/008  
 24/442  
 2014/0245592 A1 \* 9/2014 Burkhart ..... G09F 7/20  
 29/525.11  
 2016/0333906 A1 ‡ 11/2016 Varga ..... F16B 2/18  
 2017/0119108 A1 \* 5/2017 Schlick ..... B60J 7/104

OTHER PUBLICATIONS

“Anchor Point,” <<http://usaprogrip.com/products/ratchets-3-2/bar-handle-2-2/>>, 1 page, retrieved on Apr. 27, 2018.

\* cited by examiner

‡ imported from a related application

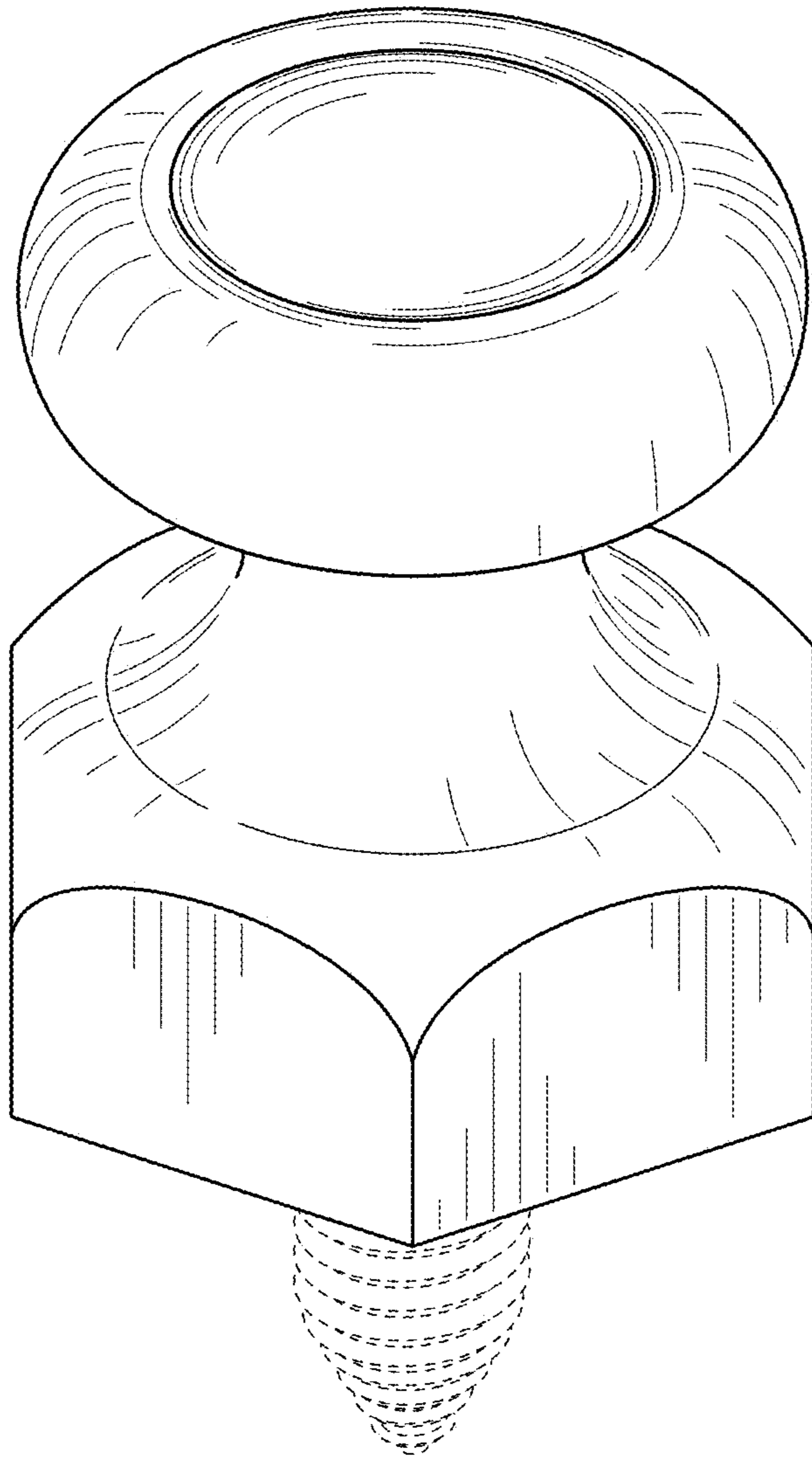

FIG. 1

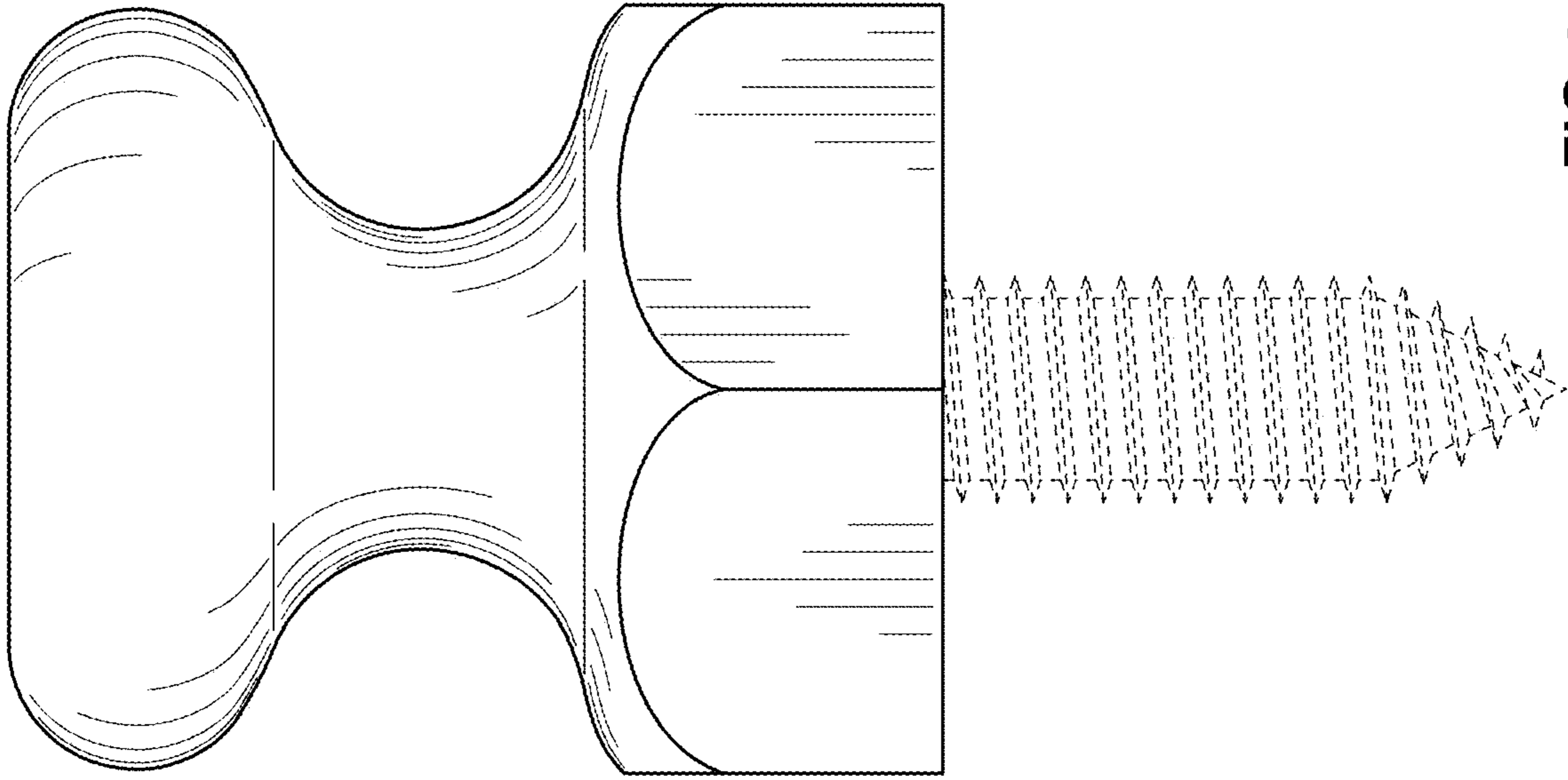

FIG. 3

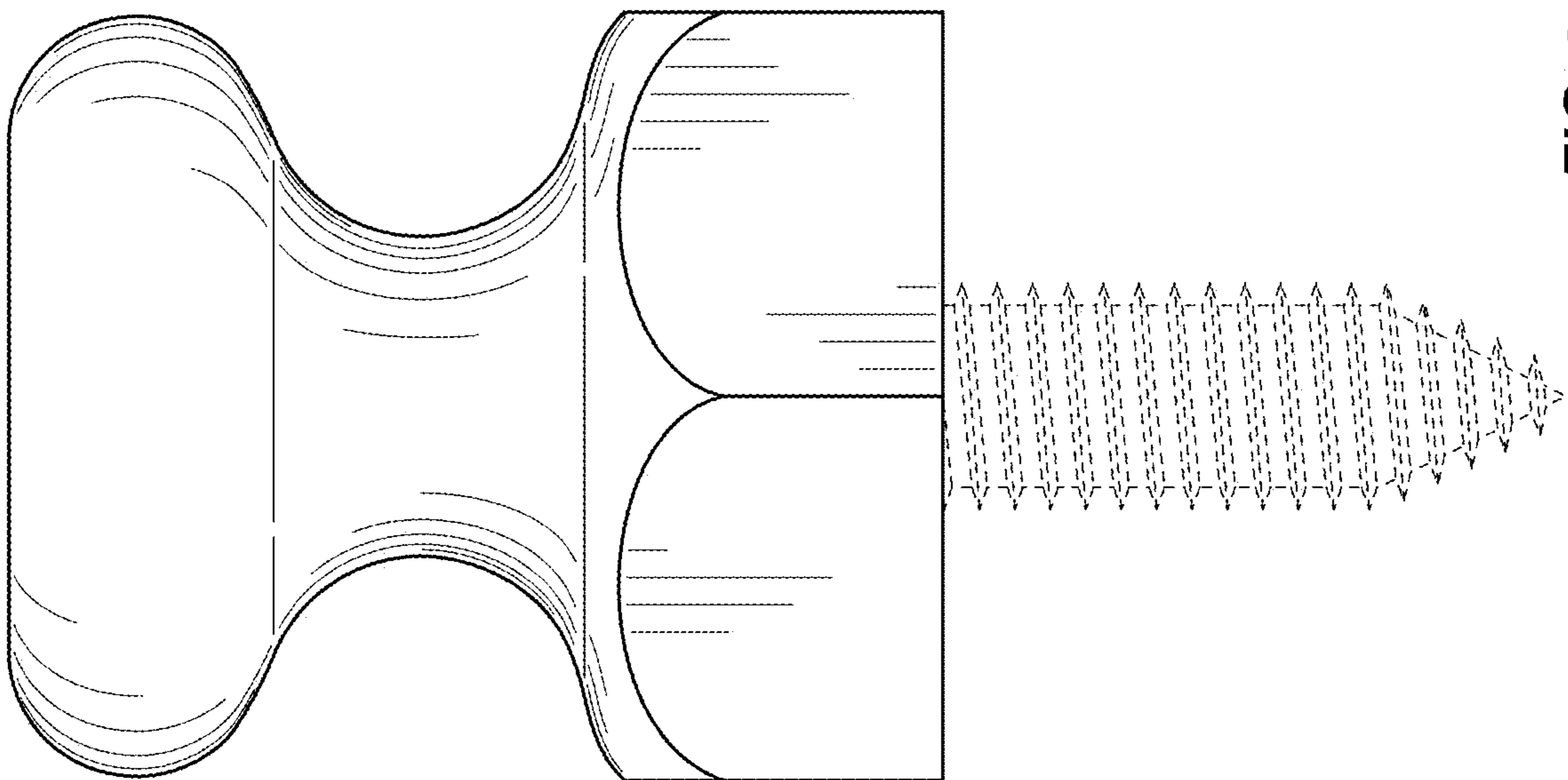

FIG. 2

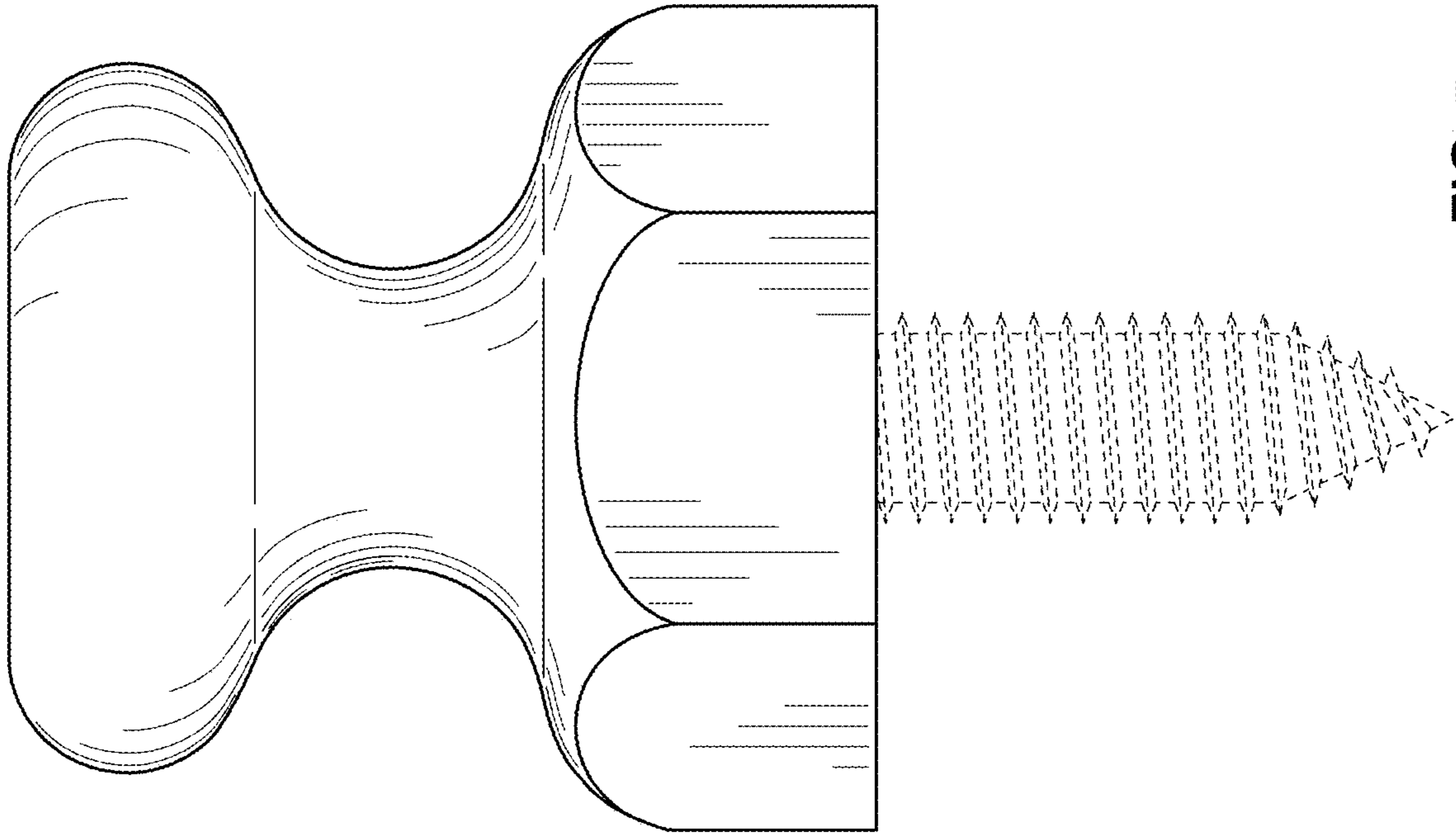

FIG. 5

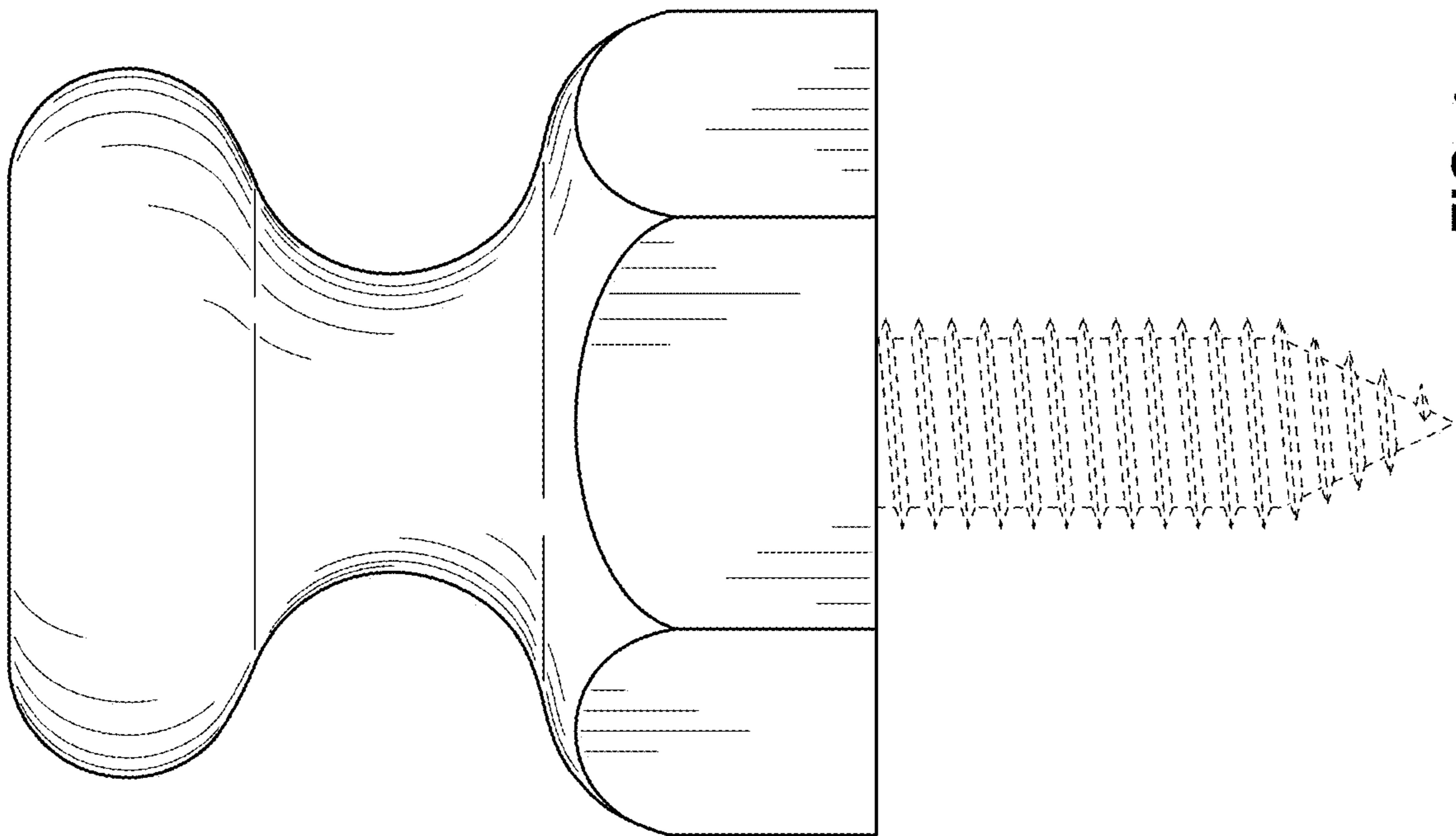

FIG. 4

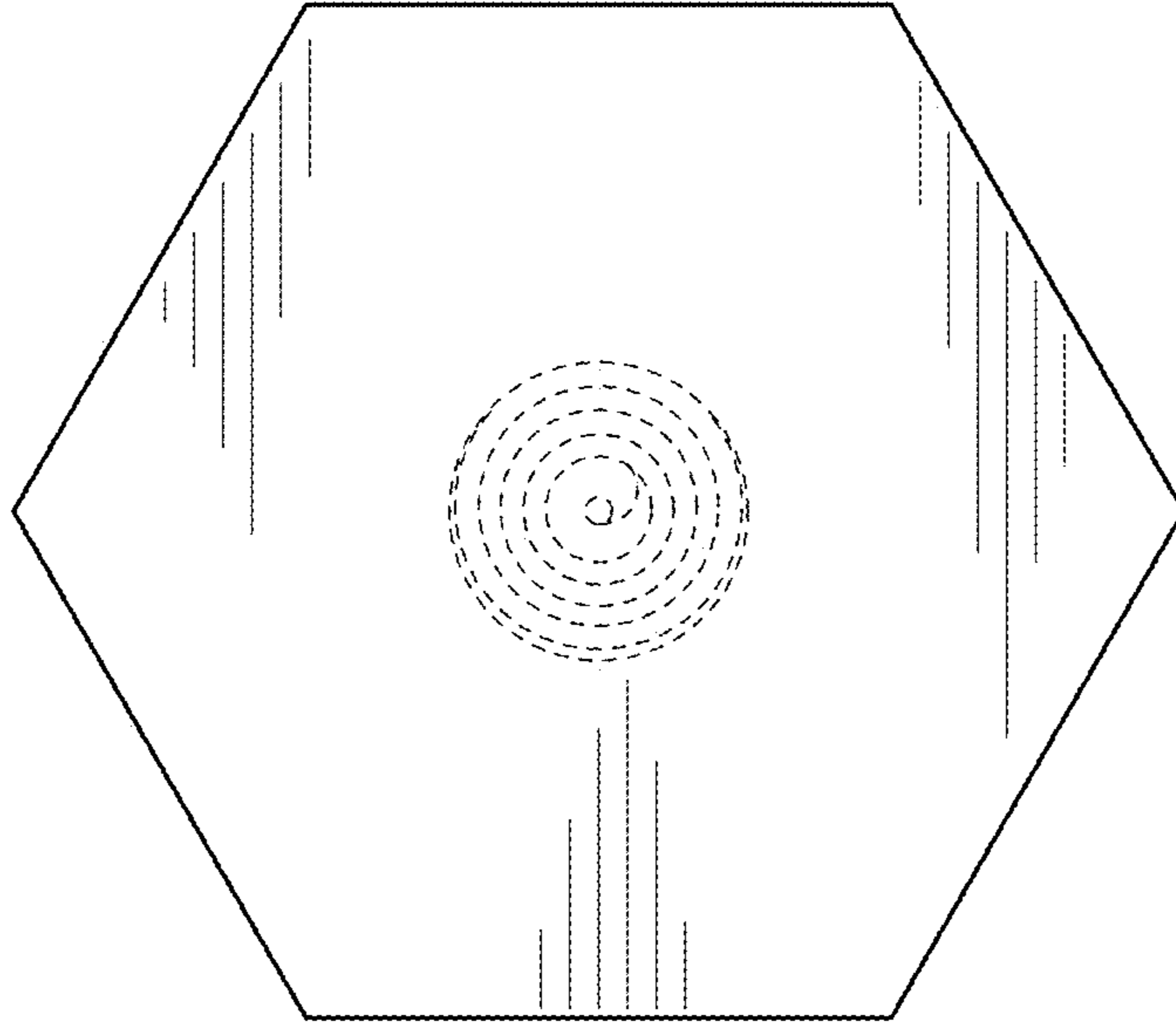

FIG. 7

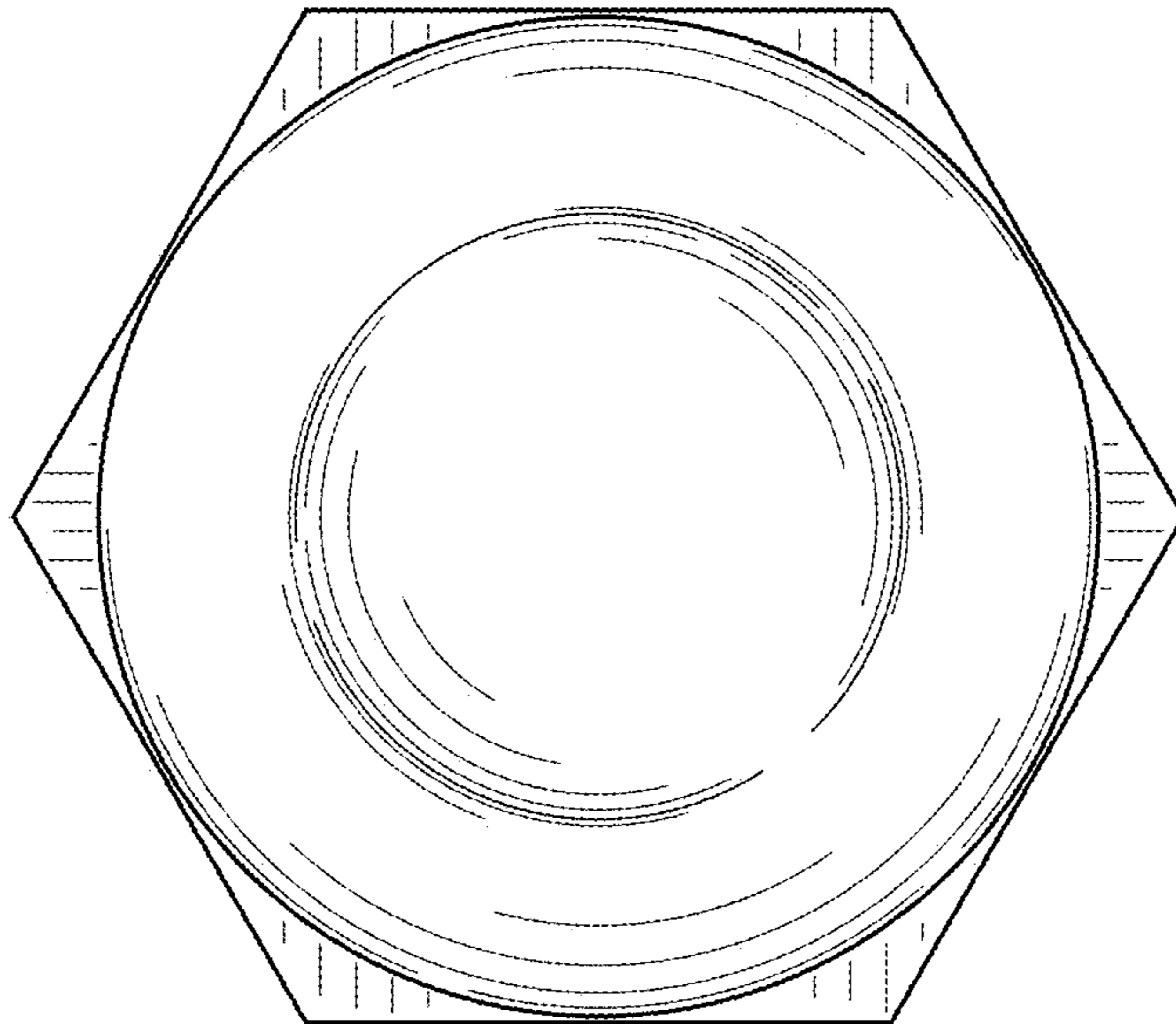

FIG. 6