



US00D929166S

(12) **United States Design Patent**
Omdahl, II et al.

(10) **Patent No.:** **US D929,166 S**

(45) **Date of Patent:** **** Aug. 31, 2021**

(54) **STRAW**
(71) Applicant: **Runway Blue, LLC**, Alpine, UT (US)
(72) Inventors: **John R. Omdahl, II**, Lindon, UT (US);
Jim Allen Colby, Highland, UT (US)
(73) Assignee: **Runway Blue, LLC**, Alpine, UT (US)
(**) Term: **15 Years**

6,523,711 B1 2/2003 Hughes et al.
6,676,032 B2 * 1/2004 Banach A47G 21/18
239/24
7,093,735 B2 8/2006 Stephens
D583,425 S * 12/2008 Kushner D21/686
7,513,388 B2 4/2009 Maher
D655,356 S * 3/2012 Sandman D21/679
8,172,454 B2 * 5/2012 Choi A47J 43/0716
366/147
D699,064 S * 2/2014 Katterheinrich D7/300.2
(Continued)

(21) Appl. No.: **29/714,899**
(22) Filed: **Nov. 26, 2019**
(51) **LOC (13) Cl.** **07-06**
(52) **U.S. Cl.**
USPC **D7/300.2**
(58) **Field of Classification Search**
USPC D27/101; D7/300, 300.2, 301, 635;
D23/205, 209
CPC B65D 81/26; B65D 2517/0049; A47G
21/18; A47G 21/187; A61J 7/0038
See application file for complete search history.

OTHER PUBLICATIONS

BlenderBottle website, BlenderBottle Straw, Publication date unknown,
[site visited Jun. 5, 2021], Available on the Internet URL <https://www.blenderbottle.com/products/blenderbottle-straw> (Year: 2021).*
(Continued)

Primary Examiner — Karen S Acker
Assistant Examiner — Steven B Reinholdt, Jr.
(74) *Attorney, Agent, or Firm* — Sterne, Kessler,
Goldstein & Fox P.L.L.C.

(56) **References Cited**

U.S. PATENT DOCUMENTS

1,253,579 A * 1/1918 Deanes A61J 9/00
215/11.1
3,107,711 A * 10/1963 Azmus A22C 7/00
241/169.2
3,897,002 A * 7/1975 Witty B05B 1/10
239/288
4,925,040 A 5/1990 Wang
5,282,541 A 2/1994 Chen
5,431,297 A 7/1995 Rosello
5,590,542 A 1/1997 Wang
5,918,854 A 7/1999 Barrash et al.
6,193,101 B1 2/2001 Murphy et al.
6,196,413 B1 3/2001 Tung
6,427,928 B1 8/2002 Hirota et al.
6,431,382 B1 8/2002 Li

(57) **CLAIM**
The ornamental design for a straw, as shown and described.

DESCRIPTION

FIG. 1 is a bottom right perspective view of a straw showing the claimed design;
FIG. 2 is a top left perspective view thereof;
FIG. 3 is a bottom view thereof;
FIG. 4 is a top view thereof;
FIG. 5 is a left side view thereof;
FIG. 6 is a right side view thereof;
FIG. 7 is a front view thereof; and,
FIG. 8 is a rear view thereof.
The broken lines in the figures show portions of the straw that form no part of the claimed design.

1 Claim, 4 Drawing Sheets

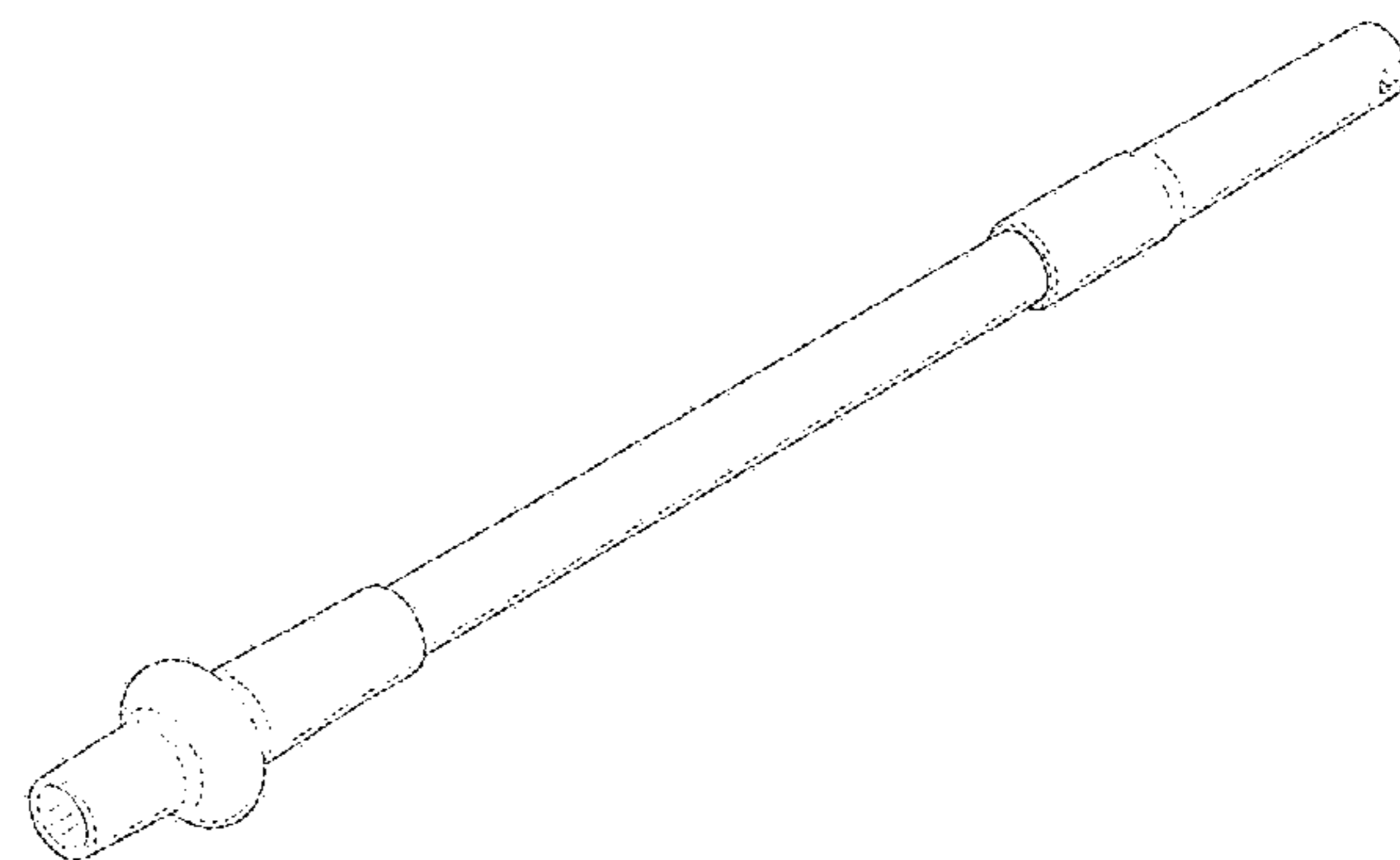
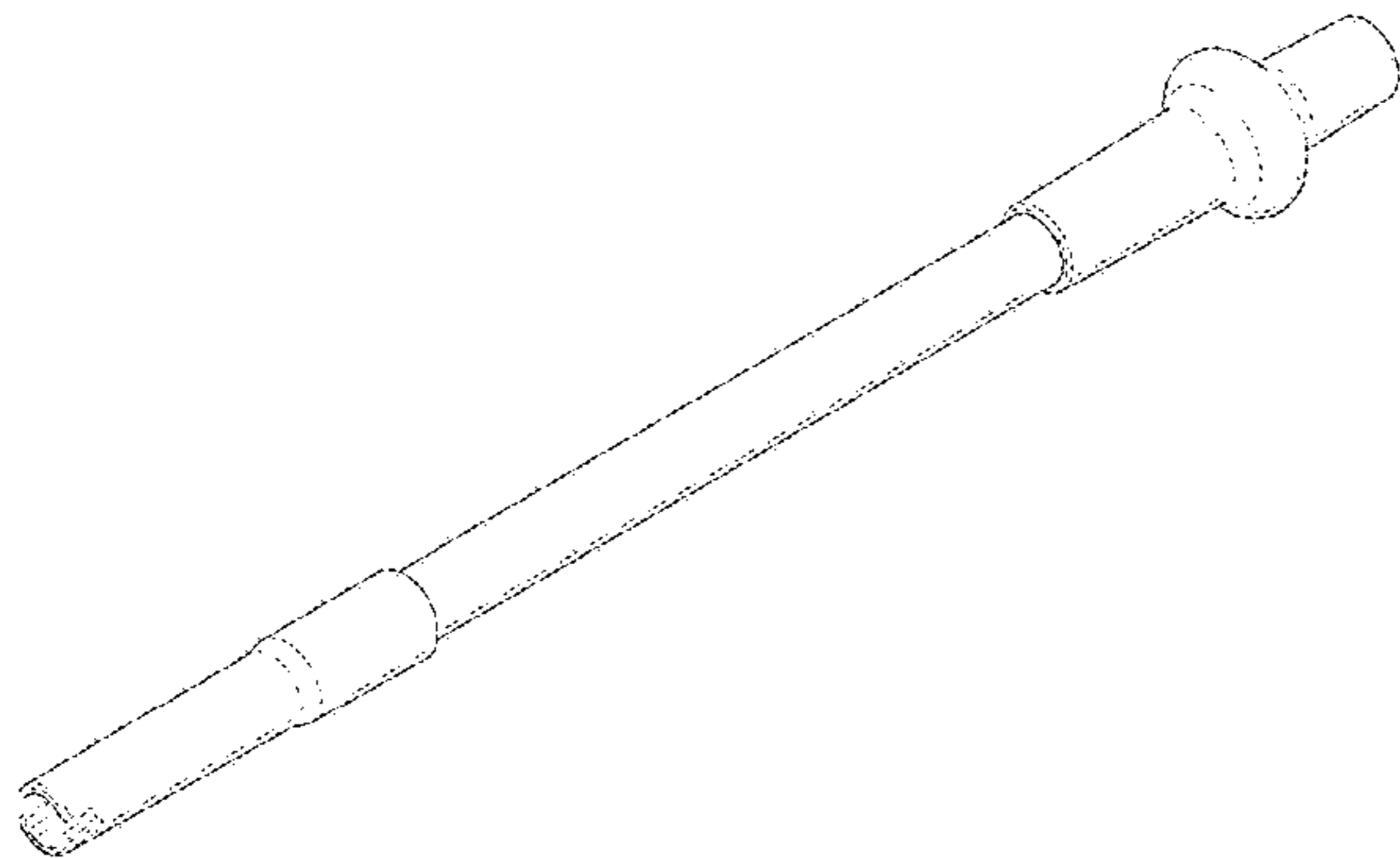

(56)

References Cited

U.S. PATENT DOCUMENTS

D720,967 S * 1/2015 Melzer D7/682
 9,380,898 B2 7/2016 Mason
 D762,408 S * 8/2016 Palazzi D7/300.2
 D763,035 S * 8/2016 Hume D7/372
 D789,742 S * 6/2017 Moore D7/412
 10,252,840 B2 4/2019 Mebberson
 D853,165 S * 7/2019 Nordwall D7/300.2
 D857,438 S * 8/2019 Nordwall D7/300.2
 D888,483 S * 6/2020 Lin D7/300.2
 D899,171 S * 10/2020 Yu D7/300.2
 D910,484 S * 2/2021 Perlin D11/184
 2002/0170874 A1 11/2002 Hou
 2005/0182356 A1 * 8/2005 Dixon A61J 7/0038
 604/77
 2010/0092309 A1 * 4/2010 Hockemeier A47G 21/18
 417/53

2015/0208853 A1 * 7/2015 Melzer A23L 2/56
 426/425
 2015/0379390 A1 * 12/2015 Morris B01L 3/5453
 235/492
 2017/0275061 A1 9/2017 Mebberson

OTHER PUBLICATIONS

Target website, BlenderBottle 28oz V2 classic water bottle with straw, Publication date unknown, [site visited Jun. 5, 2021], Available on the Internet URL <https://www.target.com/p/blenderbottle-28oz-v2-classic-water-bottle-with-straw-blue/-/A-80218537#lnk=sametab> (Year: 2021).
 HydroJug Straw, site visited Jan. 10, 2020, Available from internet: <https://www.thehydrojug.com/collections/accessories/products/hydrostraw>.

* cited by examiner

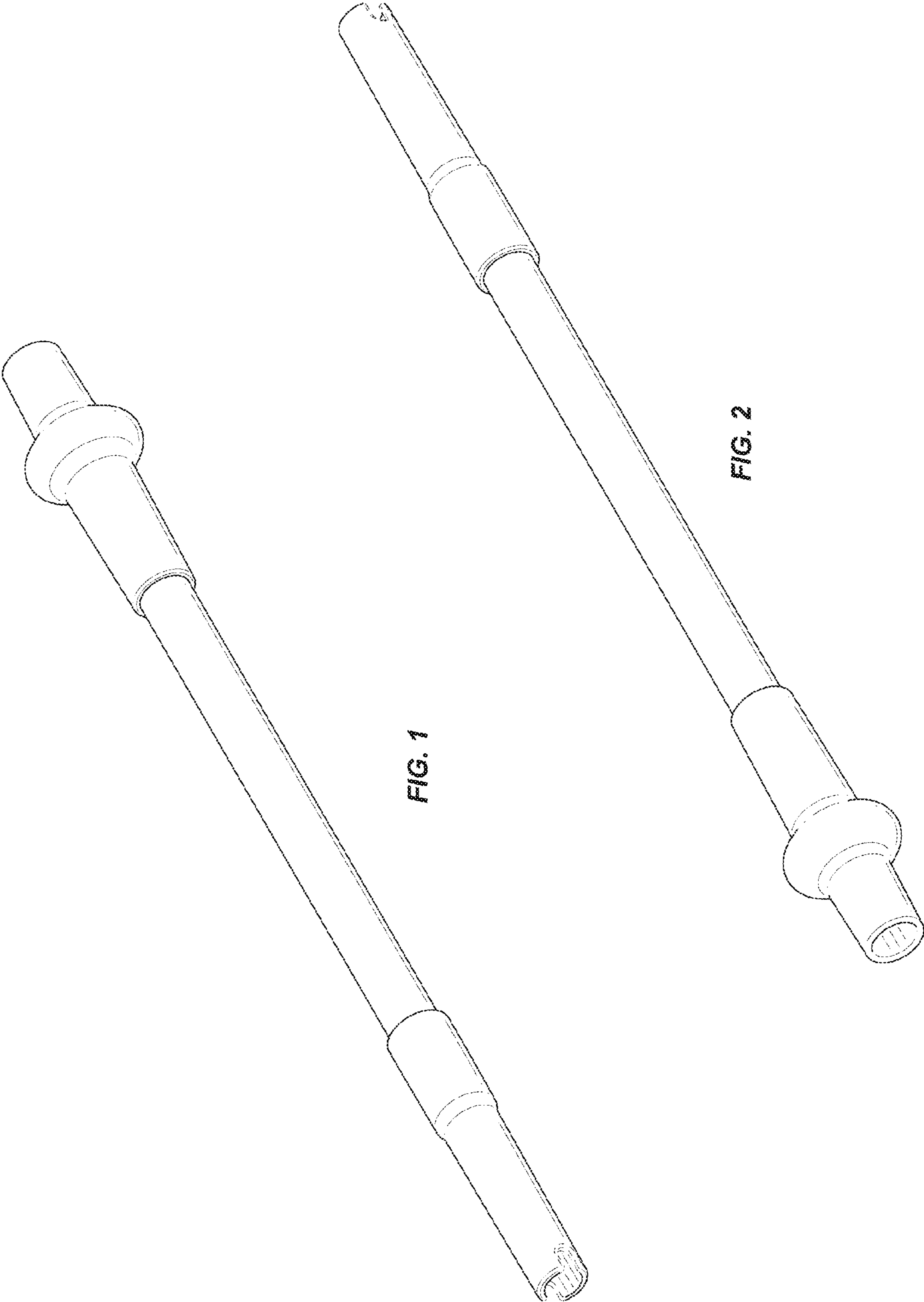

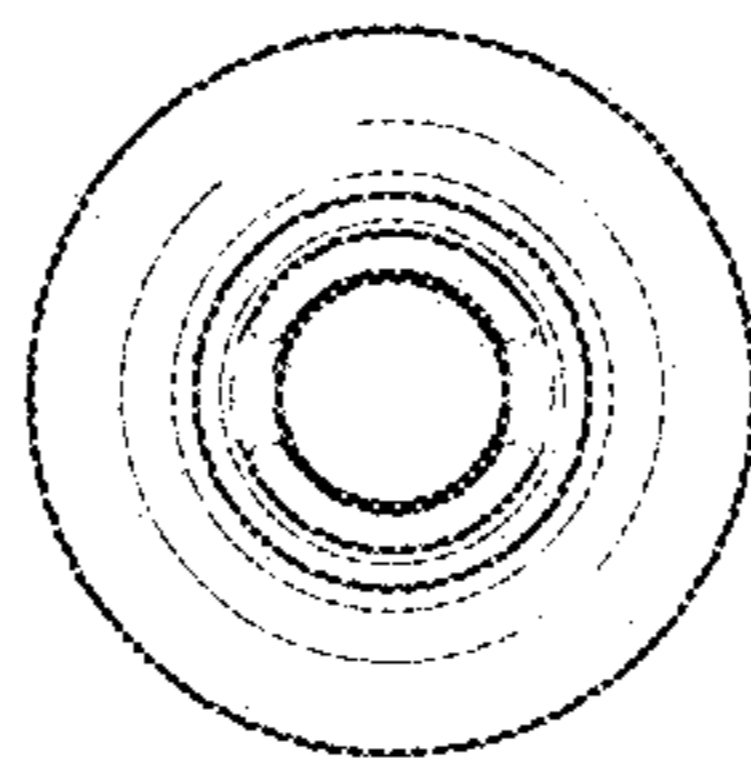

FIG. 3

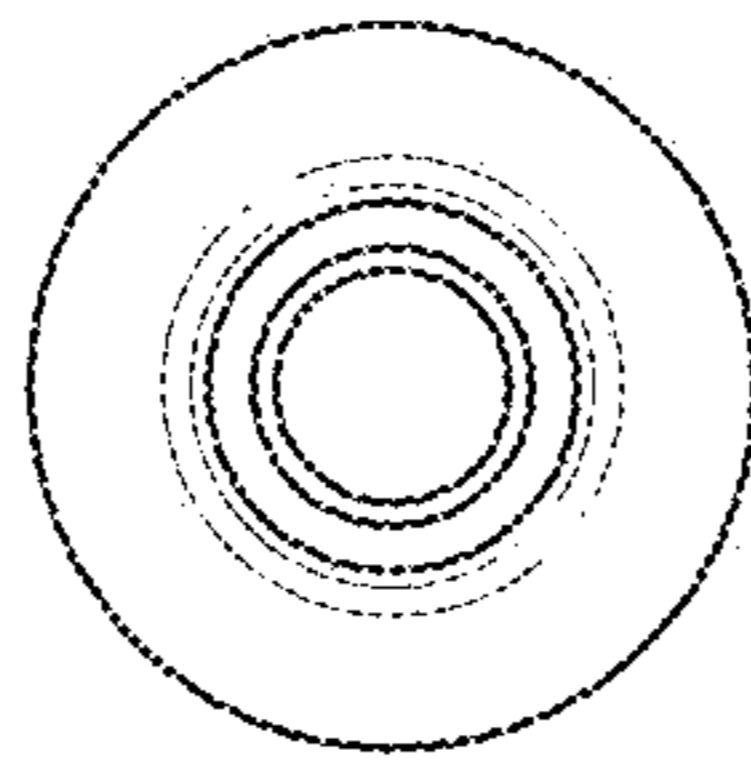

FIG. 4

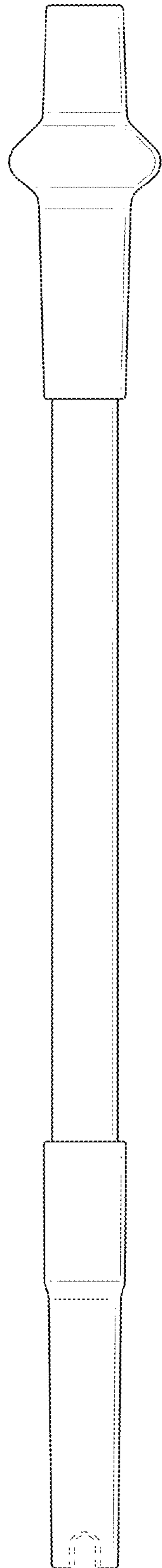

FIG. 5

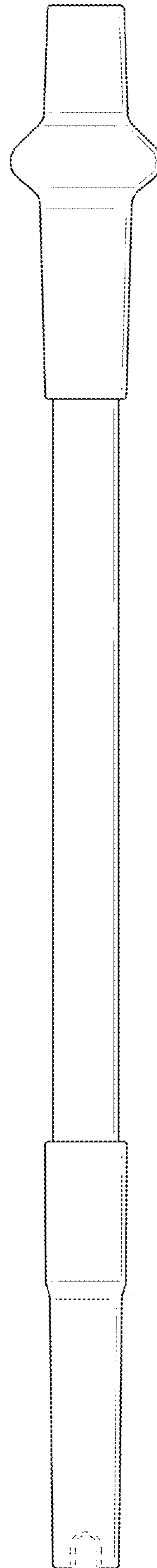

FIG. 6

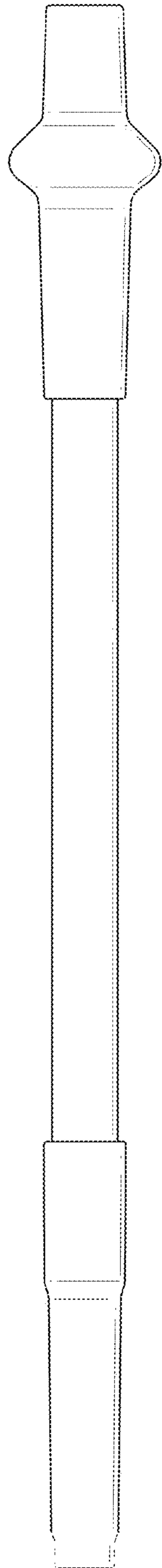

FIG. 7

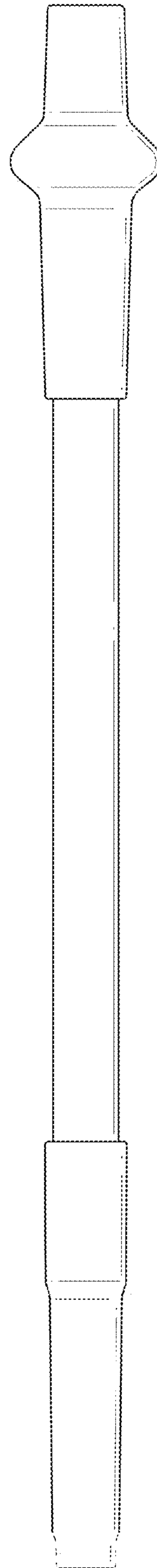

FIG. 8