



US00D929097S

(12) **United States Design Patent** (10) **Patent No.:** **US D929,097 S**  
**Winskowicz et al.** (45) **Date of Patent:** **\*\* Aug. 31, 2021**

- (54) **GOLF SHOE**
- (71) Applicant: **SQAIRZ**, Windham, NH (US)
- (72) Inventors: **Robert Winskowicz**, Windham, NH (US); **Joseph Napurano**, Natick, MA (US)
- (73) Assignee: **SQAIRZ**, Windham, NH (US)
- (\*\*) Term: **15 Years**
- (21) Appl. No.: **29/712,977**
- (22) Filed: **Nov. 13, 2019**
- (51) **LOC (13) Cl.** ..... **02-04**
- (52) **U.S. Cl.**  
USPC ..... **D2/957**; D2/906; D2/947; D2/951;  
D2/955; D2/962
- (58) **Field of Classification Search**  
USPC ..... D2/896, 902, 906, 908, 916, 918, 925,  
D2/946-962, 977, 937, 938, 942, 945  
CPC ..... A43B 13/00; A43B 13/02; A43B 13/023;  
A43B 13/026; A43B 13/04; A43B 13/08;  
A43B 13/10; A43B 1/14; A43B 7/00  
See application file for complete search history.

- 5,301,442 A 4/1994 Williams
- 5,381,614 A 1/1995 Goldstein
- D400,346 S 11/1998 Singer
- D406,938 S 3/1999 Lin
- D412,392 S 8/1999 Singer
- D416,670 S 11/1999 Singer
- 6,457,976 B1 10/2002 Fleshman

(Continued)

**FOREIGN PATENT DOCUMENTS**

DE 202006015135 U1 3/2007

**OTHER PUBLICATIONS**

ARROW-White with Red, Sqairz.com, [online], [site visited Jan. 13, 2021], <URL:http://sqairz.com/sqairz-arrow-whitered/> (year: 2021).

(Continued)

*Primary Examiner* — T Chase Nelson  
*Assistant Examiner* — Laura H Yu  
(74) *Attorney, Agent, or Firm* — Cantor Colburn LLP

(57) **CLAIM**

We claim, the ornamental design for a golf shoe, as shown and described.

**DESCRIPTION**

FIG. 1 is a perspective view of a golf shoe, showing our new design;  
FIG. 2 is another perspective view thereof;  
FIG. 3 is a top plan view thereof;  
FIG. 4 is a bottom plan view thereof;  
FIG. 5 is a side elevation view thereof;  
FIG. 6 is an opposite side elevation view thereof;  
FIG. 7 is a front view thereof; and,  
FIG. 8 is a rear view thereof;  
The broken lines in the figures illustrate portions of the golf shoe that form no part of the claimed design.

**1 Claim, 8 Drawing Sheets**

(56) **References Cited**  
U.S. PATENT DOCUMENTS

- 2,503,586 A 2/1946 Miller
- 3,175,827 A 3/1965 Livingood
- 3,244,421 A 4/1966 Hanna
- 4,186,500 A 2/1980 Salzman
- 4,199,881 A 4/1980 Francis
- 4,246,708 A 1/1981 Gladek
- 4,407,079 A 10/1983 Chiroff
- 4,586,274 A 5/1986 Blair
- 4,653,206 A 3/1987 Tanel
- 4,660,304 A 4/1987 Tanel
- 4,689,901 A 9/1987 Ihlenburg
- 4,843,735 A 7/1989 Nakanishi
- 4,937,954 A 7/1990 Clement
- 5,265,354 A 11/1993 Aliano



(56)

References Cited

U.S. PATENT DOCUMENTS

D483,175 S 12/2003 Robinson  
 D507,400 S 7/2005 Robinson  
 6,912,802 B2 7/2005 Cooper  
 D509,948 S 9/2005 Robinson  
 D525,768 S 8/2006 Robinson  
 D527,876 S 9/2006 Robinson  
 D527,877 S 9/2006 Robinson  
 D540,012 S 4/2007 Robinson  
 7,228,649 B2 6/2007 Elliott  
 D552,336 S 10/2007 Parekh  
 D561,444 S 2/2008 Feeney  
 7,412,784 B1 8/2008 Bobbett  
 D581,146 S 11/2008 Lane  
 D586,989 S 2/2009 Dave  
 D587,441 S 3/2009 Lane  
 D587,442 S 3/2009 Robinson  
 D593,736 S 6/2009 Mochen  
 D593,737 S 6/2009 Mochen  
 D601,785 S 10/2009 Lane  
 D608,081 S 1/2010 Bacon  
 D612,137 S 3/2010 Duan  
 D618,895 S 7/2010 Wolff  
 8,051,583 B2 11/2011 Roether  
 D685,983 S 7/2013 Winskowicz  
 D691,679 S 10/2013 Barrett  
 8,663,025 B2 3/2014 Barrett  
 8,721,468 B1 5/2014 Barrett  
 D706,679 S 6/2014 Hilderbrand  
 D707,432 S 6/2014 Mochen  
 D707,929 S 7/2014 Feeney  
 D709,273 S 7/2014 Winskowicz  
 D709,679 S \* 7/2014 Winskowicz ..... D2/947  
 D728,205 S \* 5/2015 Weddle ..... D2/906  
 D735,975 S 8/2015 Lane  
 D752,326 S 3/2016 Bacon  
 D756,617 S 5/2016 Weddle  
 D759,361 S 6/2016 Robinson  
 D766,558 S 9/2016 Weddle  
 D793,686 S 8/2017 Bacon  
 D802,267 S 11/2017 Bacon

D825,905 S 8/2018 Bacon  
 D852,487 S \* 7/2019 Greenhalgh ..... D2/969  
 D856,638 S 8/2019 Bacon  
 D871,740 S 1/2020 Weddle  
 D886,431 S \* 6/2020 Dean ..... D2/969  
 D887,116 S \* 6/2020 Ringholz ..... D2/969  
 D893,849 S \* 8/2020 Bidal ..... D2/969  
 2002/0043008 A1 4/2002 Favreau  
 2002/0178618 A1 12/2002 Pitts  
 2004/0159019 A1 8/2004 Cooper  
 2006/0040757 A1 2/2006 Rosselli  
 2006/0242863 A1 11/2006 Patmore  
 2008/0155843 A1 7/2008 Yun  
 2009/0113757 A1 5/2009 Banik  
 2011/0185592 A1 8/2011 Nishiwaki  
 2011/0288446 A1 11/2011 Hsieh  
 2013/0210536 A1 8/2013 Winskowicz  
 2013/0333247 A1 12/2013 Grott  
 2014/0013625 A1 1/2014 Grott  
 2014/0123522 A1 5/2014 Rustam  
 2016/0366975 A1 12/2016 Toschi  
 2018/0000191 A1 1/2018 Bacon  
 2020/0046072 A1 2/2020 Bento  
 2020/0315285 A1 10/2020 Winskowicz

OTHER PUBLICATIONS

Soccer Meets the Links with the Adidas Samba Golf Shoe, Admuku.com, Posted on May 12, 2021 by Admuku.com Staff, [online], [site visited Jan. 13, 2021], <URL <https://www.abmuku.com/2012/05/12/gear/adidas-samba-golf-shoe-review-pictures/>> (year: 2012).  
 Squirz Golf Shoes—The New Shape of Innovation?, MyGolfSpy.com, By John Barba, Jun. 16, 2020 [online], [site visited Jan. 13, 2021], <URL:<https://mygolfspy.com/squirz-golf-shoes-the-new-shape-of-innovation/>> (year: 2020).  
 Mike Stachura, “Those aren’t just three lines on Phil Mickelson’s golf ball—They’re science”, Golf Digest, Feb. 20, 2019, p. 1-7, URL: <https://www.golfdigest.com/story/those-aren-t-just-three-lines-on-Phil-Mickelsons-golf-balltheyre-science/amp>.  
 British Office Report, for corresponding application GB2005059.7 Report dated Oct. 7, 2020.

\* cited by examiner



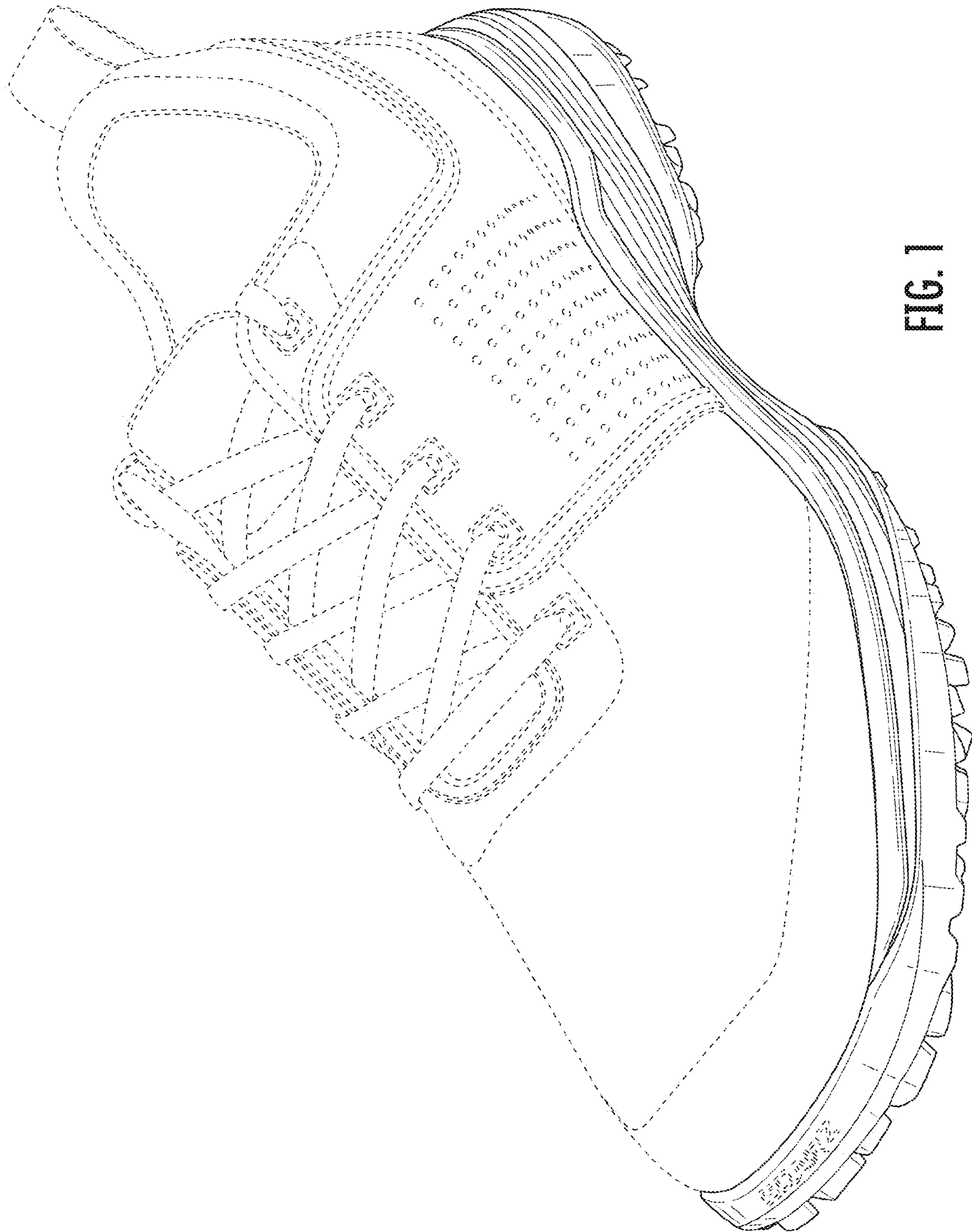

FIG. 1

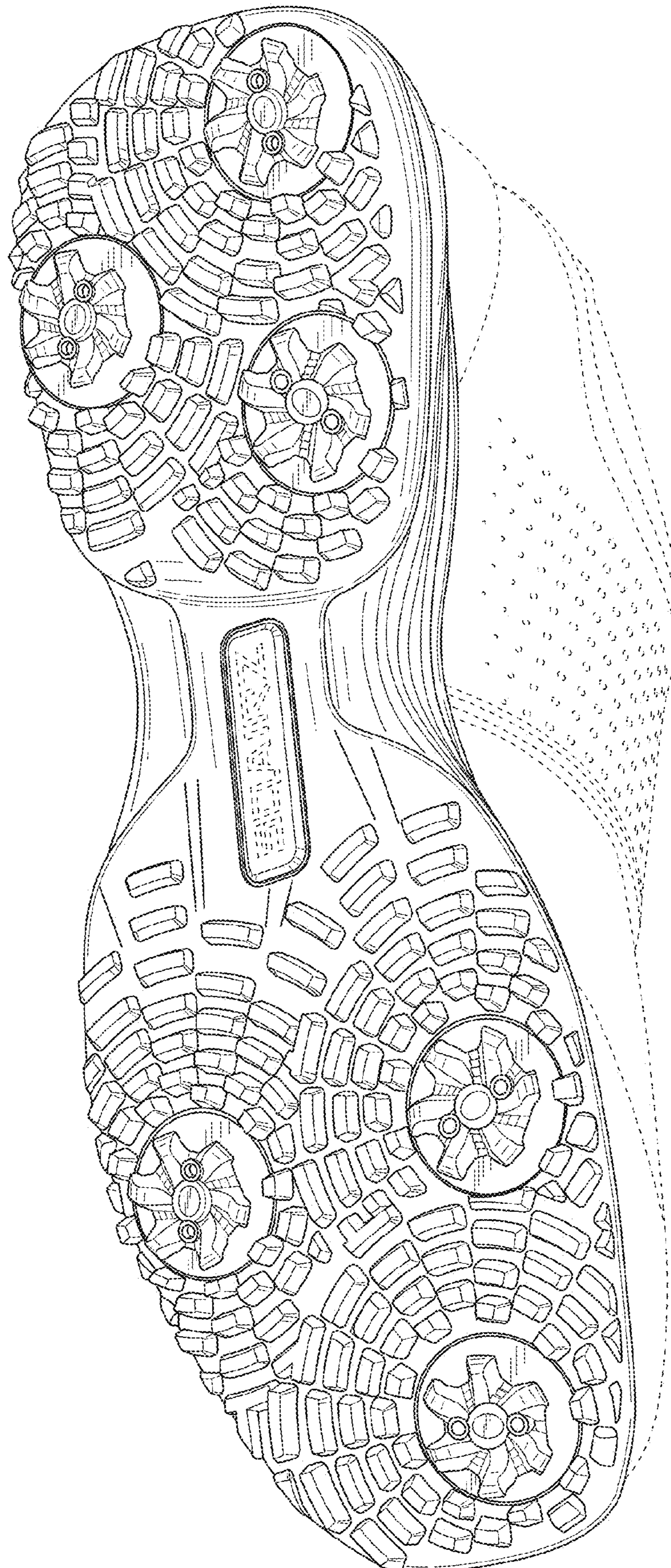

FIG. 2



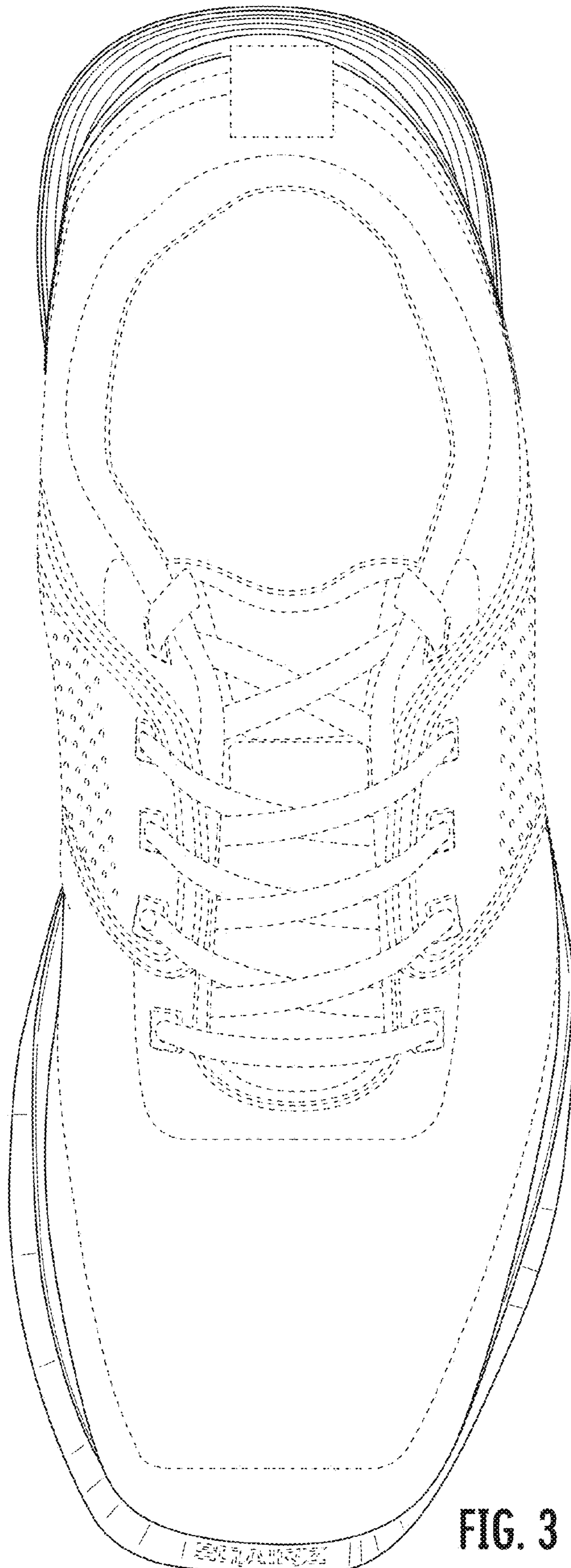

FIG. 3

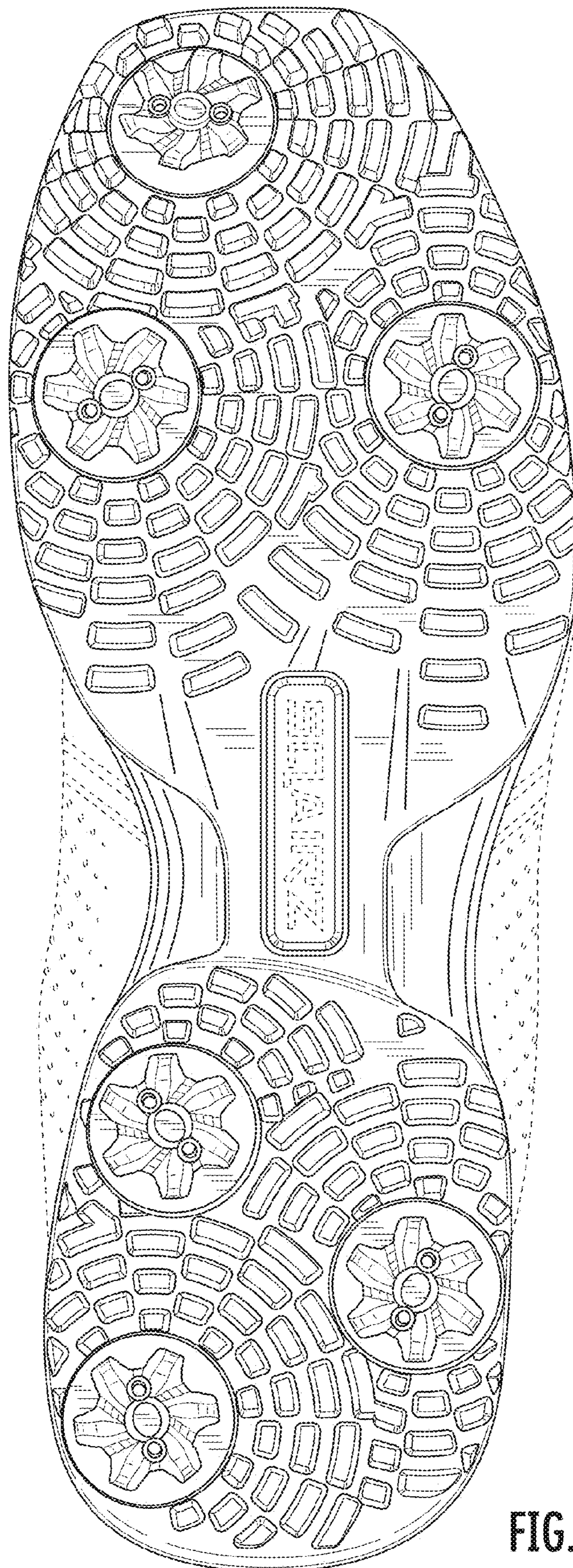

FIG. 4



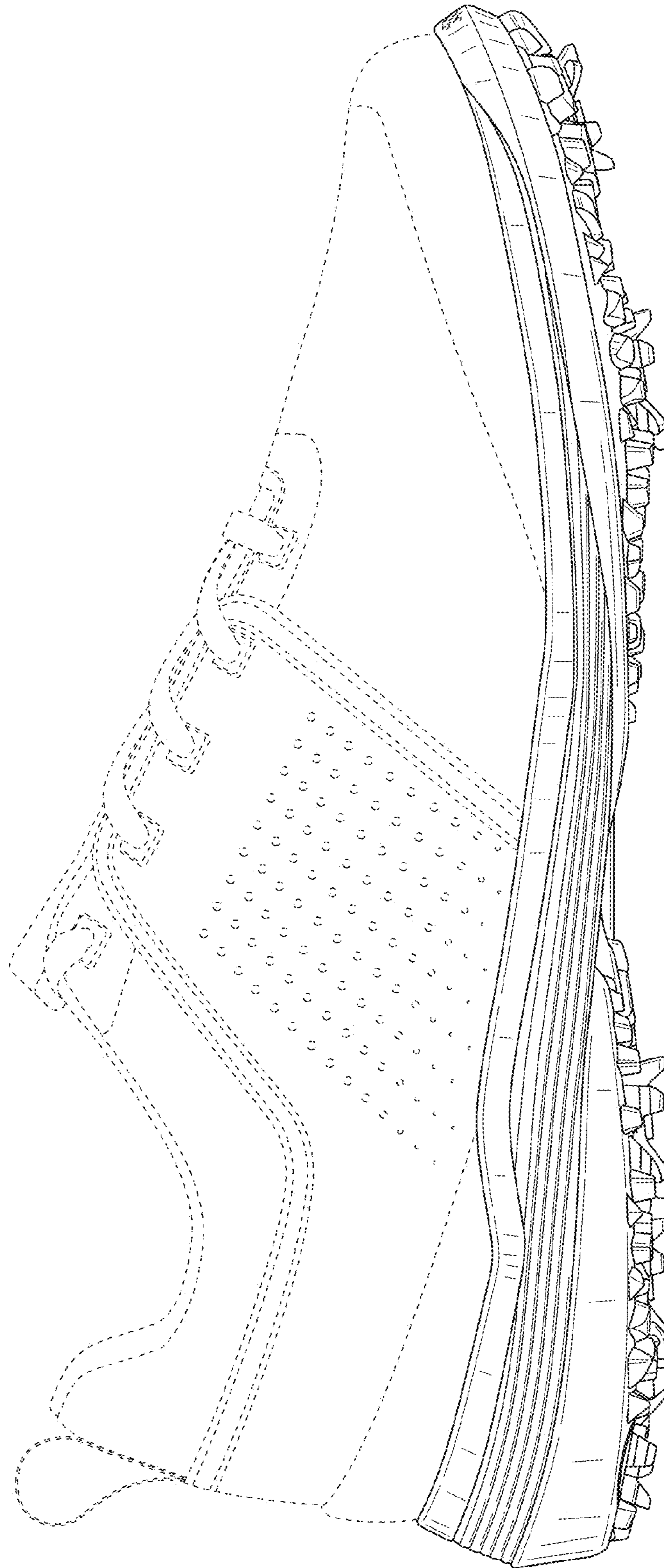

FIG. 5

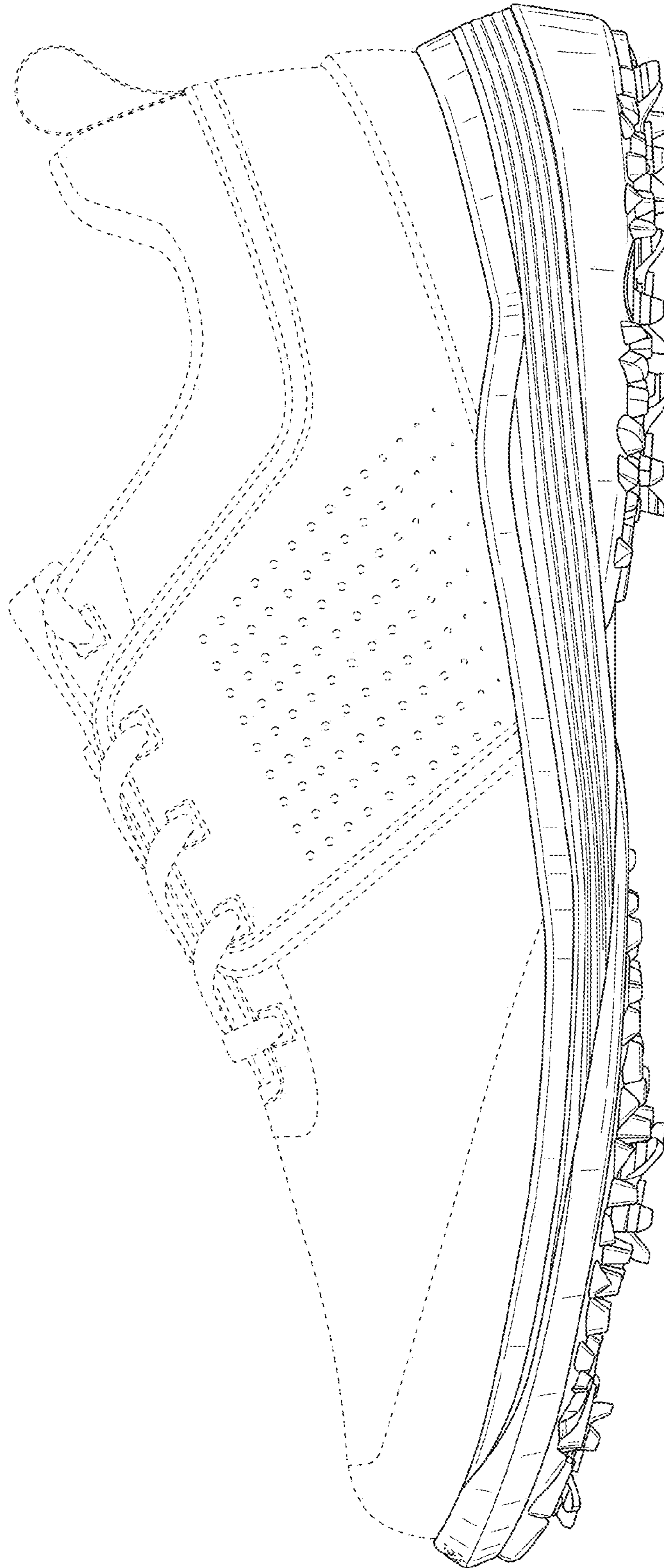

FIG. 6



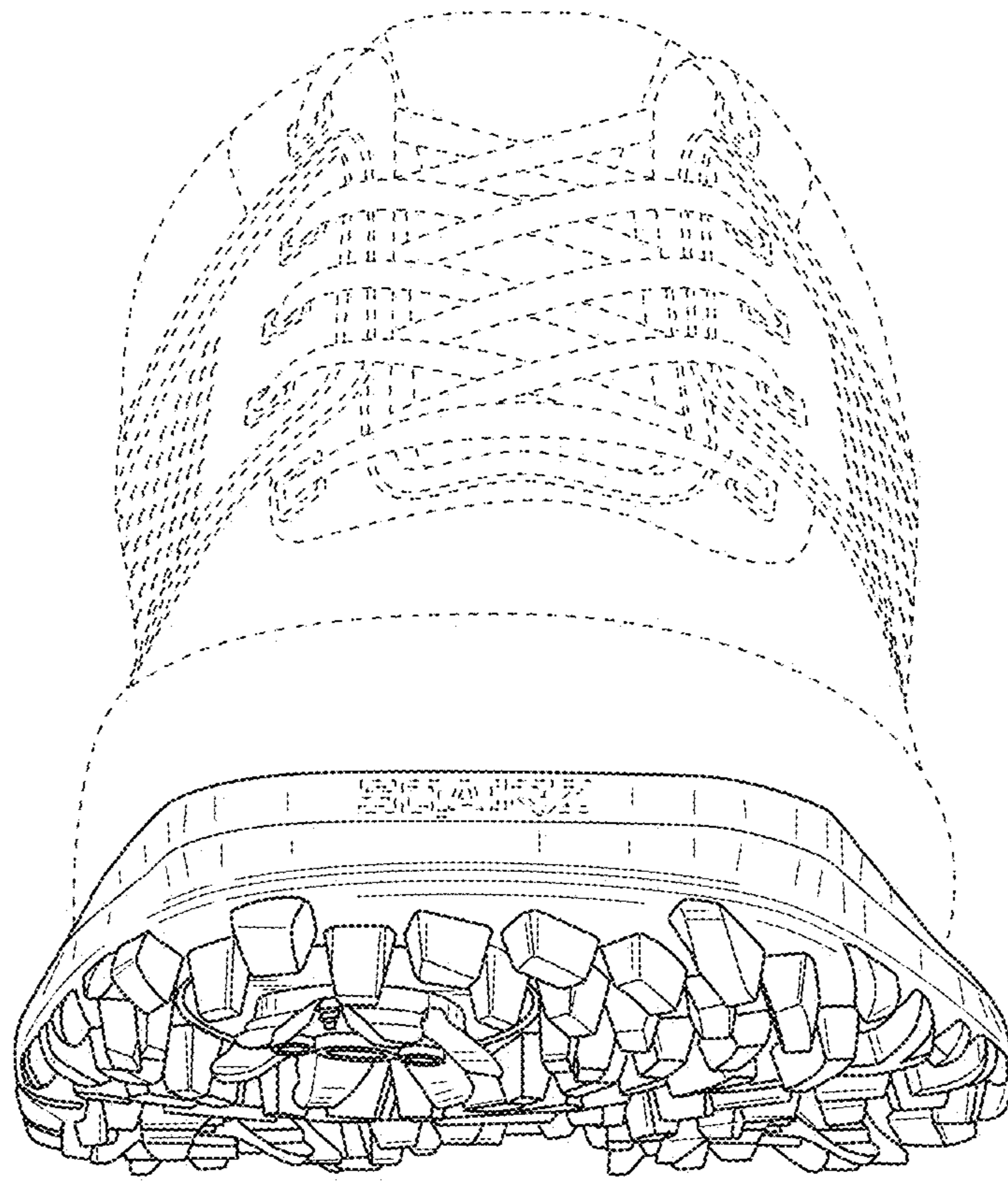

FIG. 7

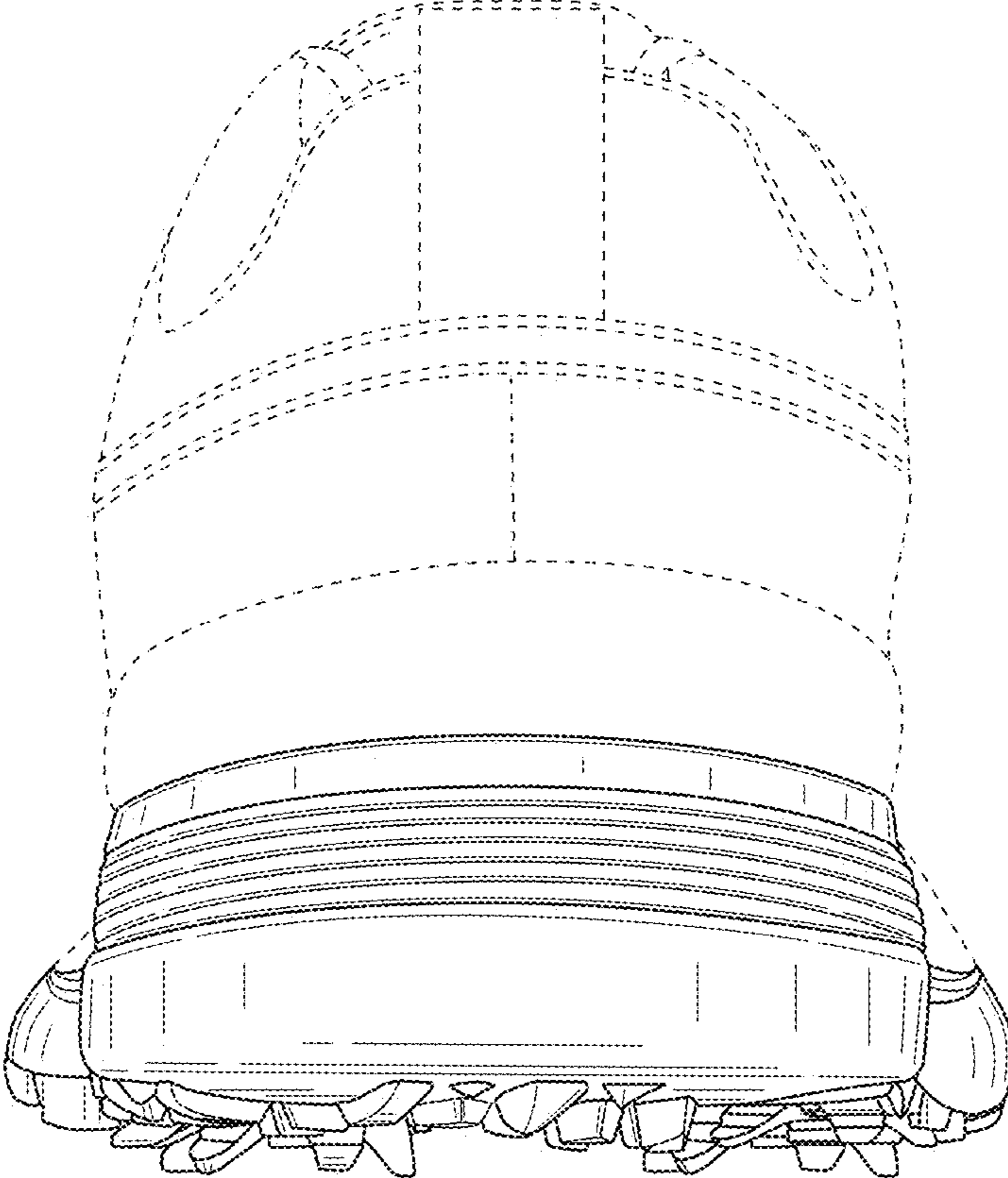

FIG. 8