

US00D929030S

(12) **United States Design Patent** (10) **Patent No.:** **US D929,030 S**
Walsh (45) **Date of Patent:** **** Aug. 24, 2021**

(54) **FRAME FOR A LITE**

(71) Applicant: **Masonite Corporation**, Tampa, FL (US)

(72) Inventor: **Jason M. Walsh**, Batavia, IL (US)

(73) Assignee: **Masonite Corporation**, Tampa, FL (US)

(**) Term: **15 Years**

(21) Appl. No.: **29/644,760**

(22) Filed: **Apr. 20, 2018**

(51) **LOC (13) Cl.** **26-05**

(52) **U.S. Cl.**
USPC **D26/138**

(58) **Field of Classification Search**
USPC D26/72, 74, 76, 78-83, 85, 86, 88, 90,
D26/93, 111, 113, 118, 119, 120, 121,
D26/122, 138, 139, 140, 141, 142, 152
(Continued)

(56) **References Cited**

U.S. PATENT DOCUMENTS

3,750,358 A 8/1973 Lewkowitz
4,920,718 A 5/1990 Artwick et al.
(Continued)

Primary Examiner — Natasha Vujcic

(74) *Attorney, Agent, or Firm* — Berenato & White, LLC

(57) **CLAIM**

The ornamental design for a frame for a lite, as shown and described.

DESCRIPTION

FIG. 1 is a front elevational view of my design;
FIG. 2 is a rear elevational view;
FIG. 3 is an enlarged fragmentary elevational view taken along the line 3-3 of FIG. 1;

FIG. 4 is a fragmentary perspective view taken along the line 4-4 of FIG. 1;
FIG. 5 is a left side view;
FIG. 6 is a right side view;
FIG. 7 is a top plan view;
FIG. 8 is a bottom plan view;
FIG. 9 is a cross-sectional view taken along the line 9-9 of FIG. 1;
FIG. 10 is a fragmentary enlarged sectional view of the portion shown in the area 10 of FIG. 9;
FIG. 11 is a front elevational view of a second version of my design;
FIG. 12 is a rear elevational view;
FIG. 13 is an enlarged fragmentary elevational view taken along the line 13-13 of FIG. 11;
FIG. 14 is a fragmentary perspective view taken along the line 14-14 of FIG. 11;
FIG. 15 is a left side view;
FIG. 16 is a right side view;
FIG. 17 is a top plan view;
FIG. 18 is a bottom plan view;
FIG. 19 is a cross-sectional view taken along the line 19-19 of FIG. 11;
FIG. 20 is a fragmentary enlarged sectional view of the portion shown in the area 20 of FIG. 19;
FIG. 21 is a front elevational view of a third version of my design;
FIG. 22 is a rear elevational view;
FIG. 23 is an enlarged fragmentary elevational view taken along the line 23-23 of FIG. 21;
FIG. 24 is a fragmentary perspective view taken along the line 24-24 of FIG. 21;
FIG. 25 is a left side view;
FIG. 26 is a right side view;
FIG. 27 is a top plan view;
FIG. 28 is a bottom plan view;
FIG. 29 is a cross-sectional view taken along the line 29-29 of FIG. 21;
FIG. 30 is a fragmentary enlarged sectional view of the portion shown in the area 30 of FIG. 29;
FIG. 31 is a front elevational view of a fourth version of my design;
FIG. 32 is a rear elevational view;
(Continued)

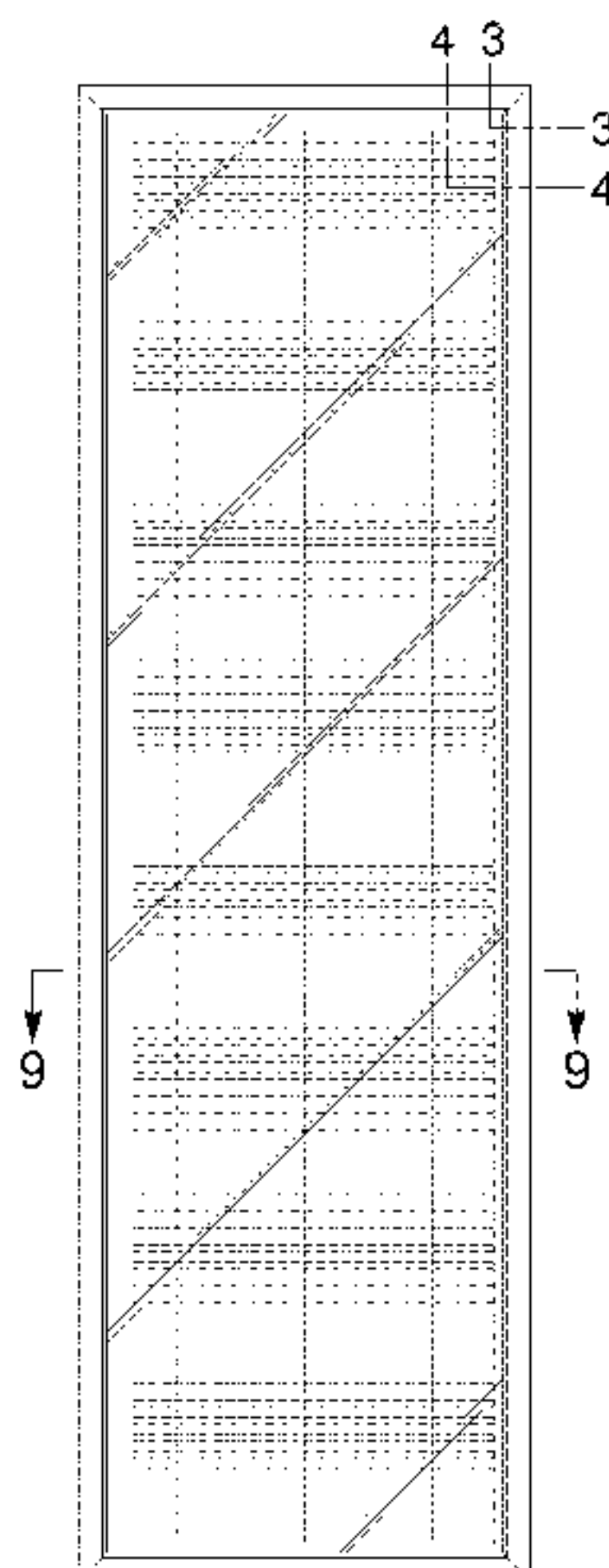

FIG. 33 is an enlarged fragmentary elevational view taken along the line 33-33 of FIG. 31;
 FIG. 34 is a fragmentary perspective view taken along the line 34-34 of FIG. 31;
 FIG. 35 is a left side view;
 FIG. 36 is a right side view;
 FIG. 37 is a top plan view;
 FIG. 38 is a bottom plan view;
 FIG. 39 is a cross-sectional view taken along the line 39-39 of FIG. 31;
 FIG. 40 is a fragmentary enlarged sectional view of the portion shown in the area 40 of FIG. 39;
 FIG. 41 is a front elevational view of a fifth version of my design;
 FIG. 42 is a rear elevational view;
 FIG. 43 is an enlarged fragmentary elevational view taken along the line 43-43 of FIG. 41;
 FIG. 44 is a fragmentary perspective view taken along the line 44-44 of FIG. 41;
 FIG. 45 is a left side view;
 FIG. 46 is a right side view;
 FIG. 47 is a top plan view;
 FIG. 48 is a bottom plan view;
 FIG. 49 is a cross-sectional view taken along the line 49-49 of FIG. 41;
 FIG. 50 is a fragmentary enlarged sectional view of the portion shown in the area 50 of FIG. 49;
 FIG. 51 is a front elevational view of a sixth version of my design;
 FIG. 52 is a rear elevational view;
 FIG. 53 is an enlarged fragmentary elevational view taken along the line 53-53 of FIG. 51;
 FIG. 54 is a fragmentary perspective view taken along the line 54-54 of FIG. 51;
 FIG. 55 is a left side view;
 FIG. 56 is a right side view;
 FIG. 57 is a top plan view;
 FIG. 58 is a bottom plan view;
 FIG. 59 is a cross-sectional view taken along the line 59-59 of FIG. 51; and,
 FIG. 60 is a fragmentary enlarged sectional view of the portion shown in the area 60 of FIG. 59.

The dashed lines in the drawings are for environment and form no part of the claimed design.

1 Claim, 47 Drawing Sheets

(58) **Field of Classification Search**
 CPC F21S 2/00; F21S 4/00; F21S 4/003; F21S 4/005; F21S 4/006; F21S 4/007; F21S 4/008; F21S 6/00; F21S 8/00; F21S 8/024; F21S 8/026; F21S 8/031; F21S 8/033; F21S 8/035-037; F21S 8/04; F21S 8/043; F21S 8/063
 See application file for complete search history.

(56) **References Cited**

U.S. PATENT DOCUMENTS

4,947,597	A	8/1990	Simpson	
5,112,175	A	5/1992	Wilkening	
5,175,970	A	1/1993	Green	
5,249,403	A	10/1993	Neilly et al.	
5,369,923	A	12/1994	Schilt	
5,470,184	A	11/1995	Chandler	
5,577,355	A	11/1996	Leonelli	
5,636,484	A	6/1997	DeBlock	
6,546,682	B1	4/2003	DeBlock et al.	
6,601,633	B2	8/2003	Sun et al.	
6,763,647	B2	7/2004	Yeany	
6,932,139	B2	8/2005	Early et al.	
D595,450	S *	6/2009	Ko	D26/120
D604,894	S *	11/2009	Peifer	D26/141
D632,008	S *	2/2011	Kim	D26/120
D649,678	S *	11/2011	Germain	D26/91
D649,679	S *	11/2011	Germain	D26/91
D668,371	S *	10/2012	Alpaslan	D26/72
D712,591	S *	9/2014	Sannella	D26/141
D714,963	S *	10/2014	Plummer	D25/60
D749,257	S *	2/2016	Arndt	D26/76
9,255,439	B2	2/2016	Goossens et al.	
D776,328	S *	1/2017	Bacus	D26/113
D784,593	S *	4/2017	Ambrozus	D26/74
D802,819	S *	11/2017	Czech	D26/76
D819,860	S *	6/2018	Clark	D26/76
D827,917	S *	9/2018	Botti	D26/138
D843,633	S *	3/2019	Zheng	D26/89
D848,047	S *	5/2019	Santoro	D26/74
D859,719	S *	9/2019	Yaphe	D26/74
D870,357	S *	12/2019	Hu	D26/120
D889,732	S *	7/2020	Silver	D26/113
D898,975	S *	10/2020	Rashidi Doust	D26/74

* cited by examiner

FIG. 1

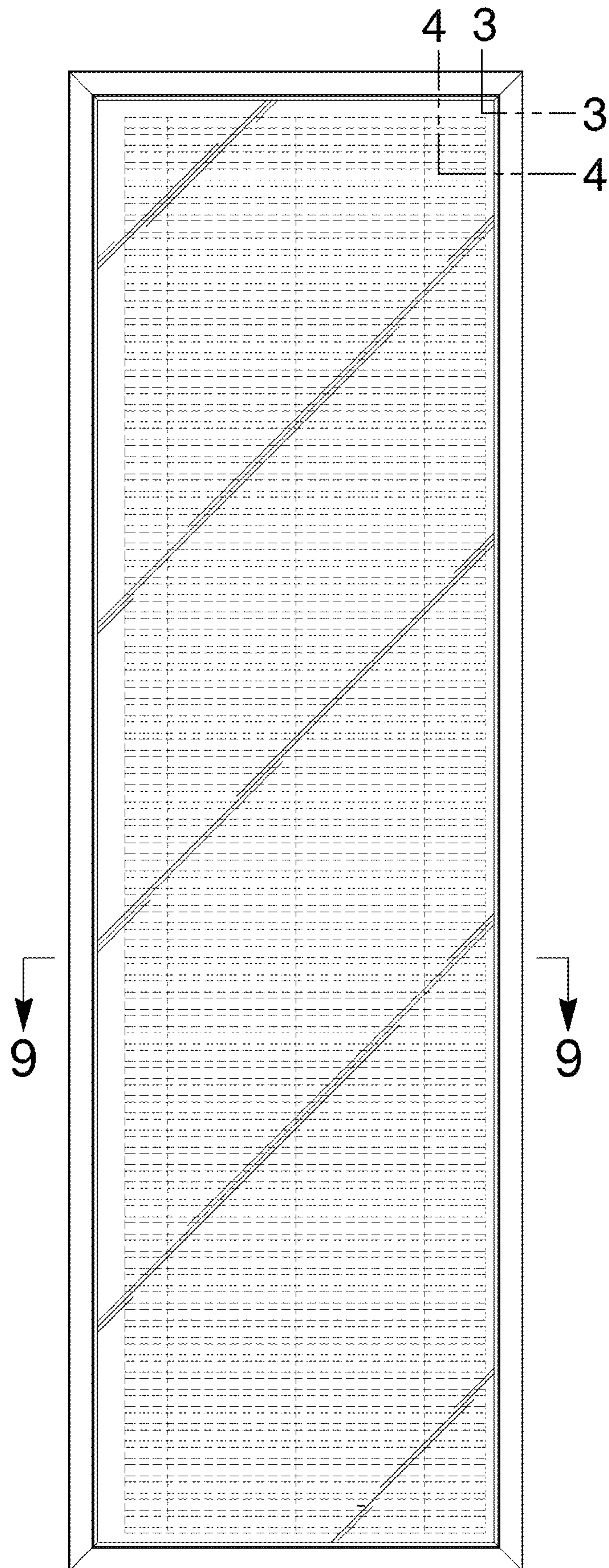

FIG. 2

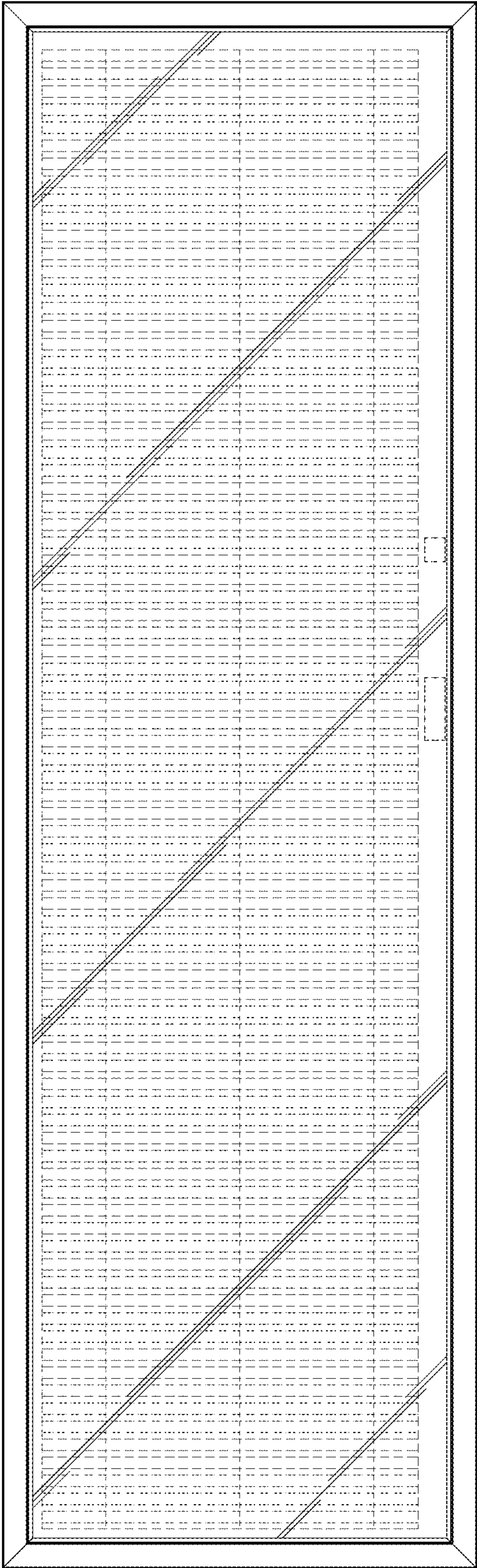
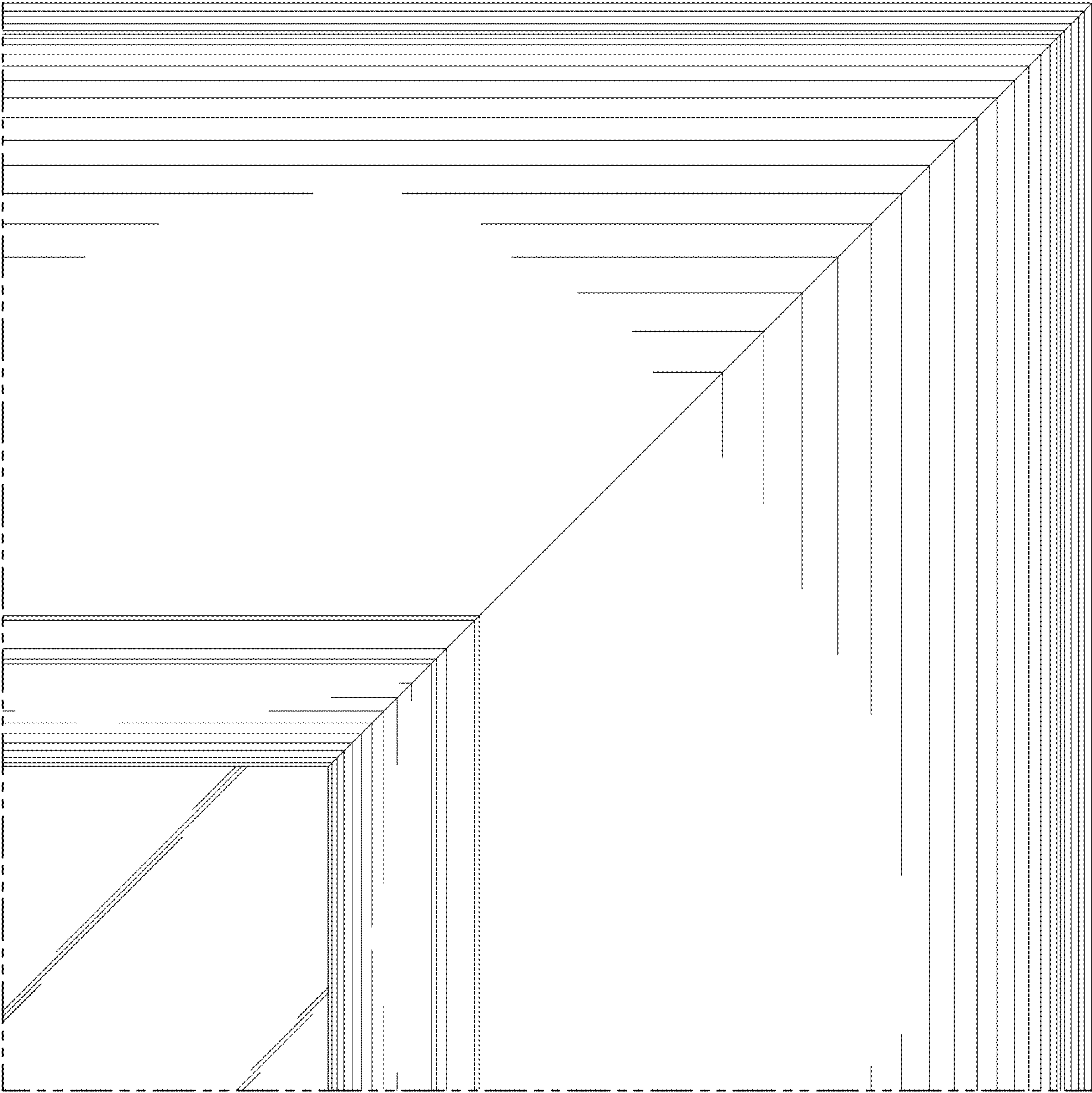

FIG. 3



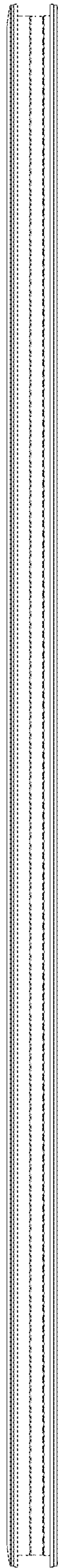

FIG. 5

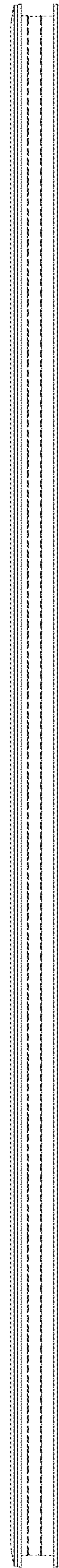

FIG. 6

FIG. 7

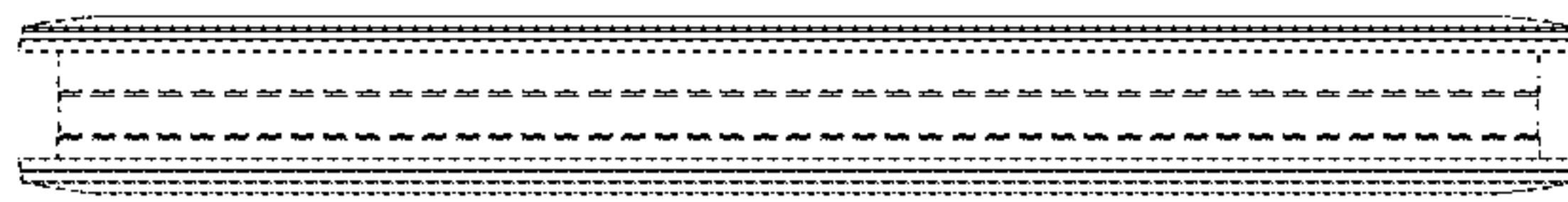

FIG. 8

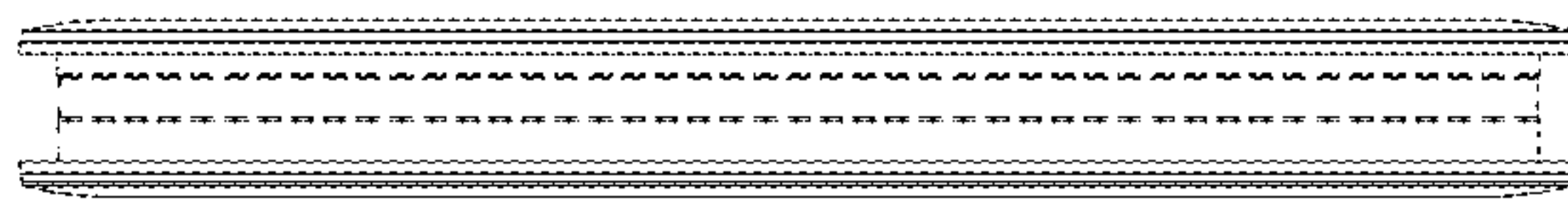
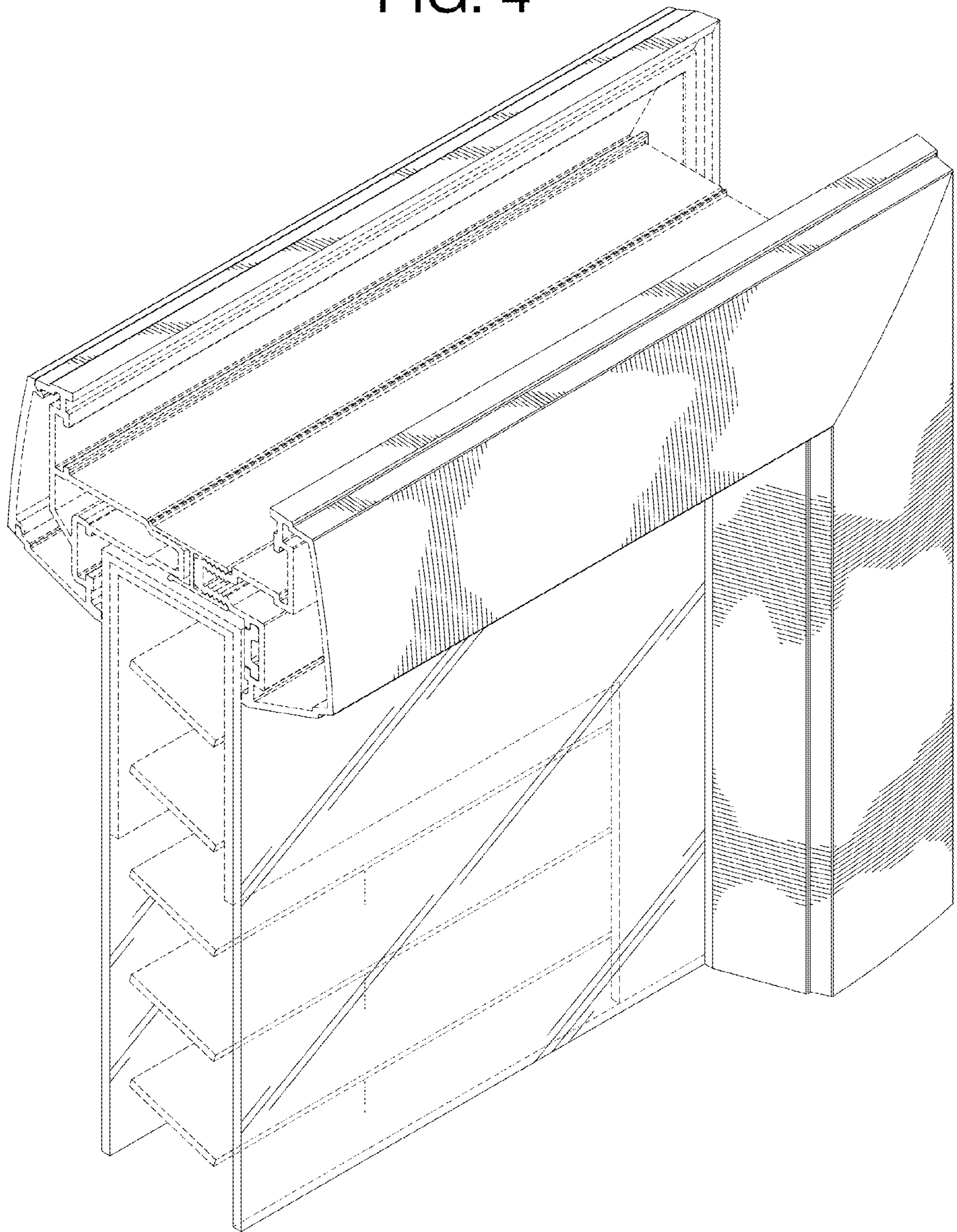

FIG. 4



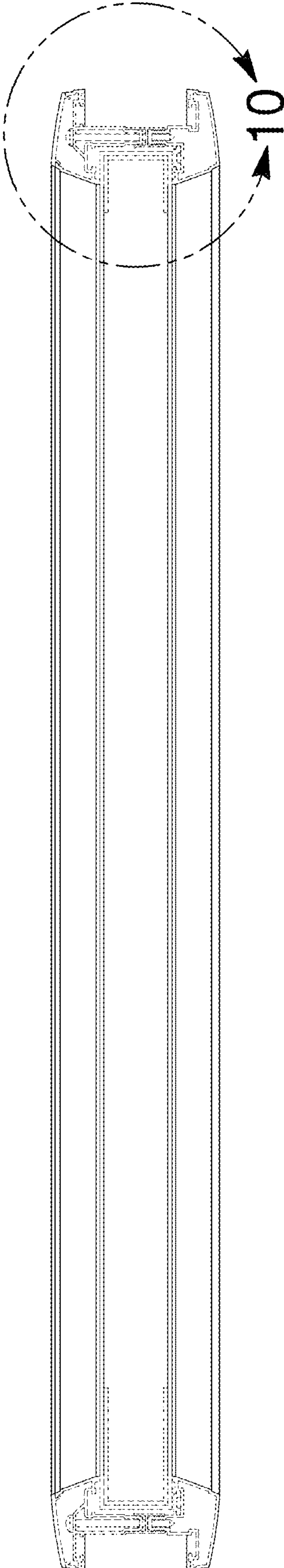

FIG. 9

FIG. 10

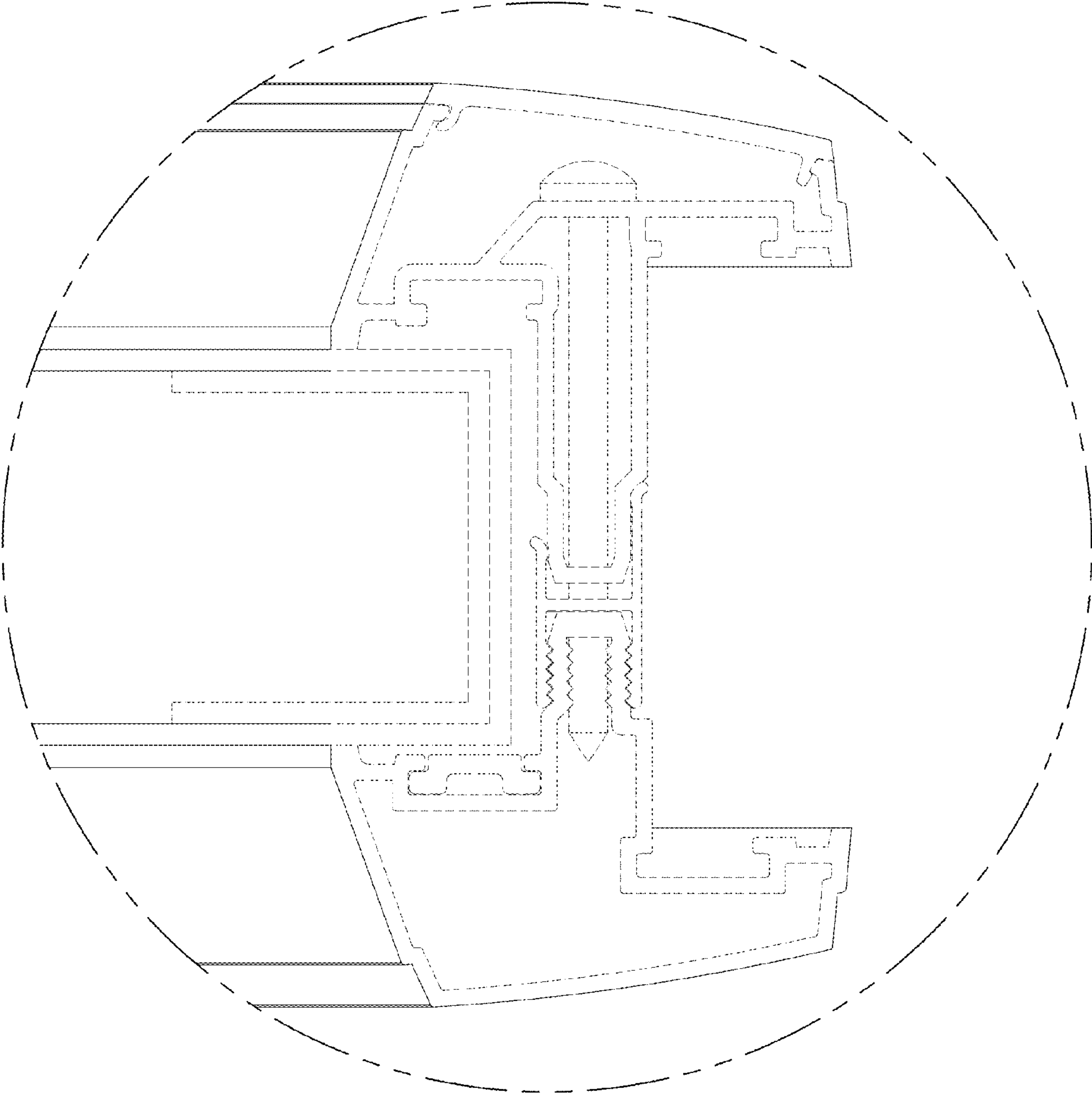

FIG. 11

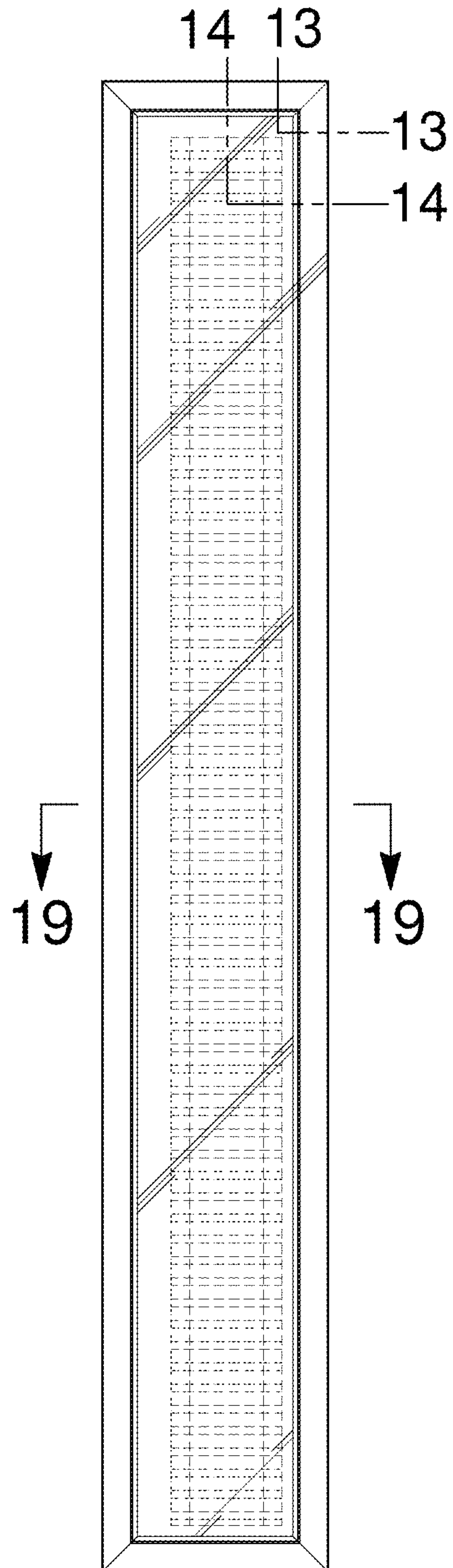

FIG. 12

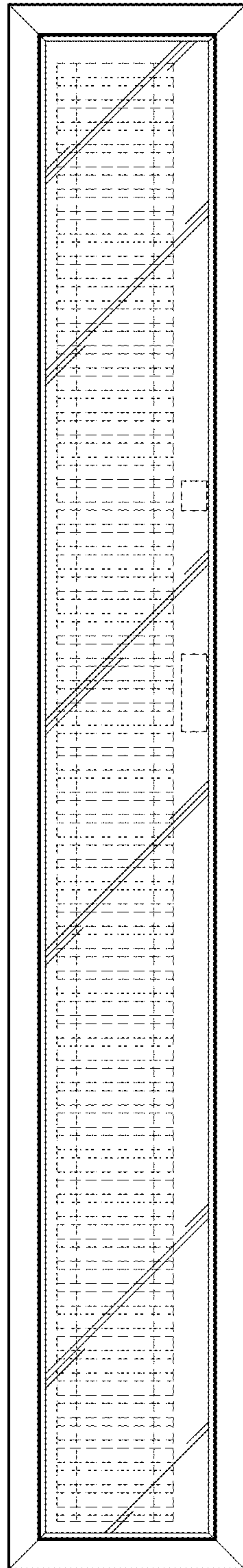

FIG. 13

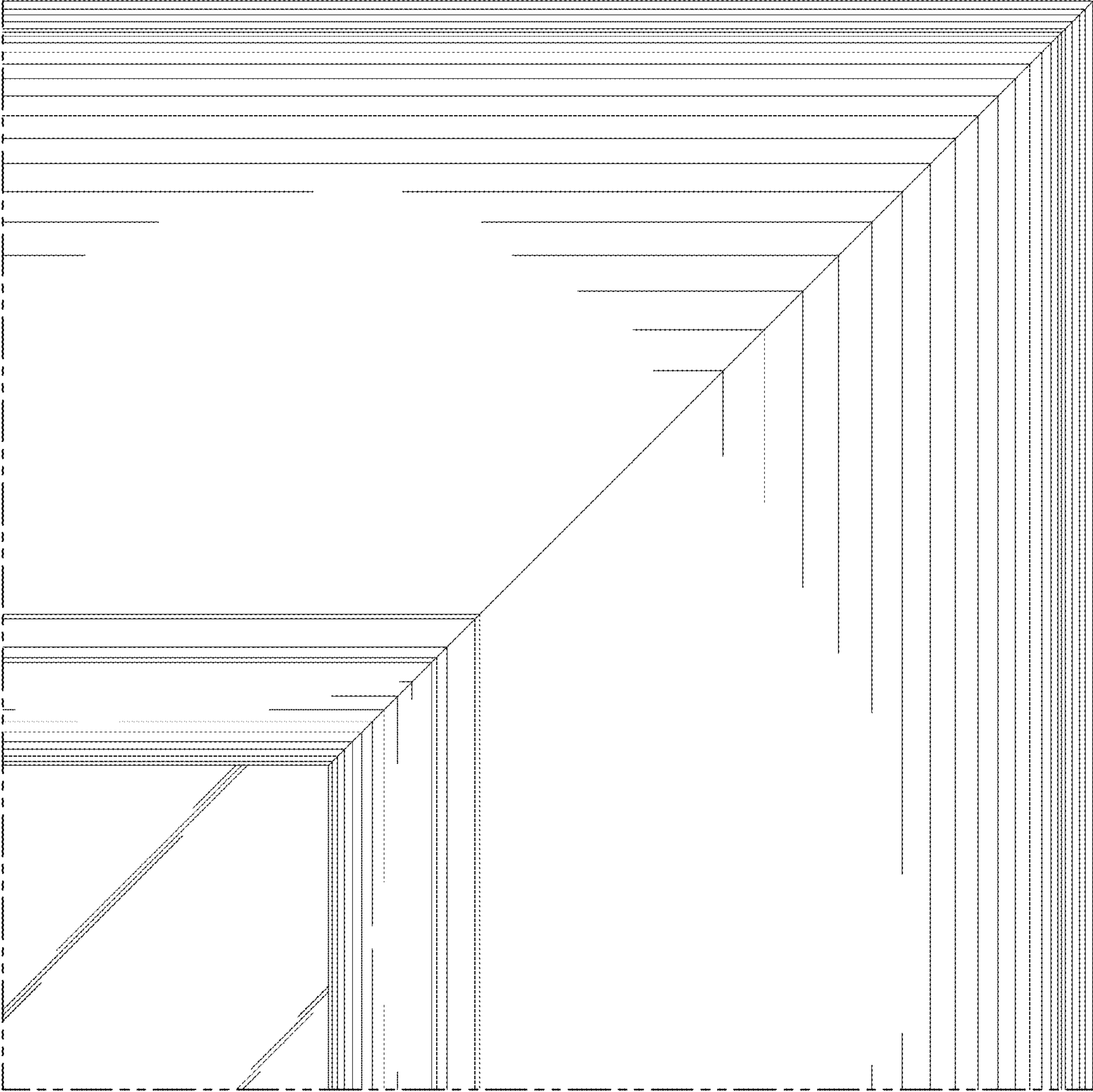

FIG. 14

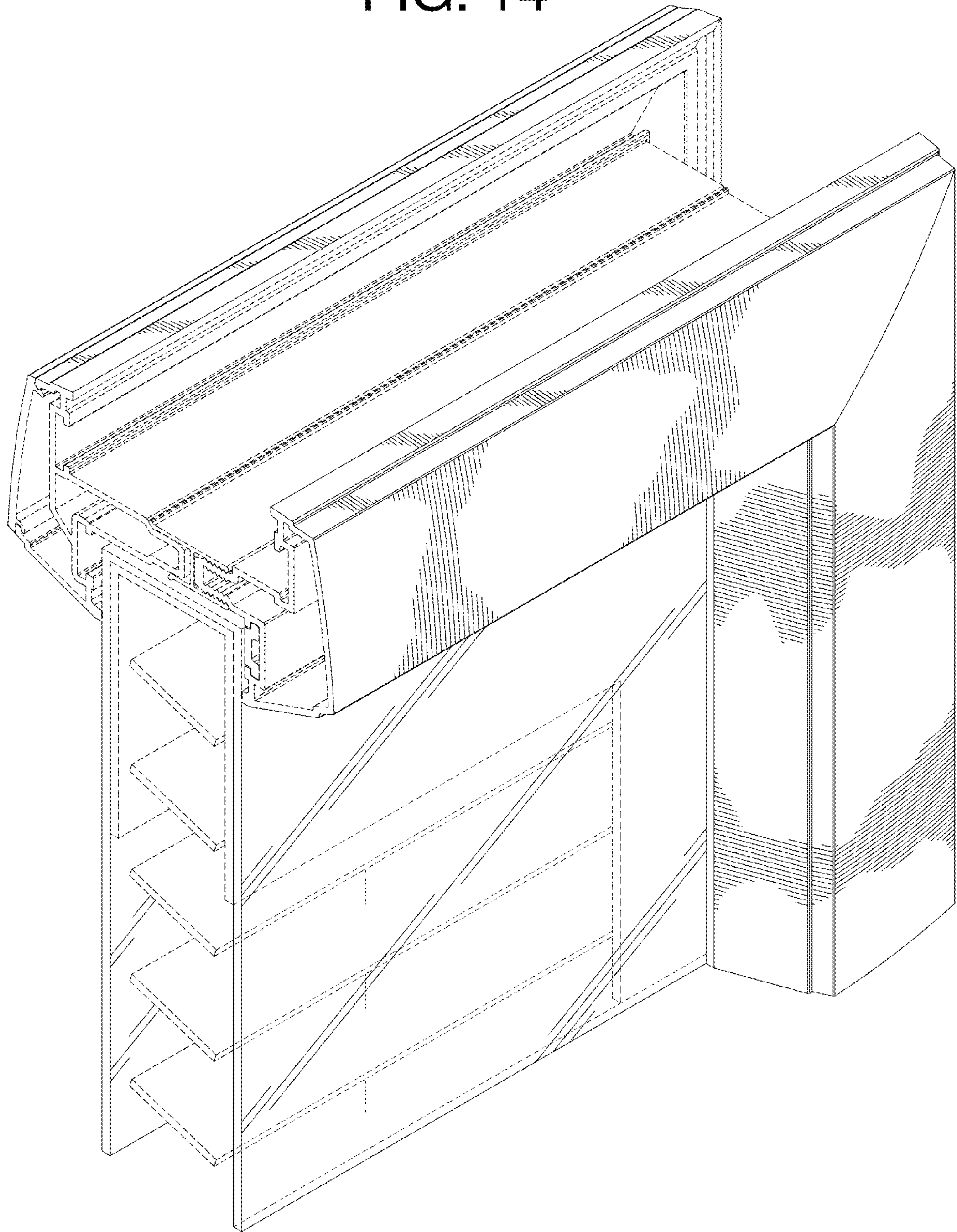

FIG. 15

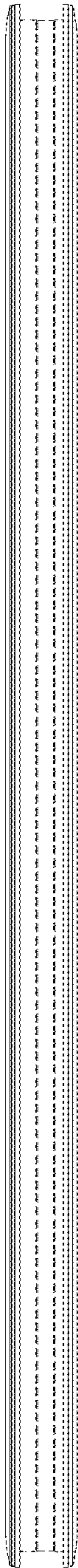

FIG. 16

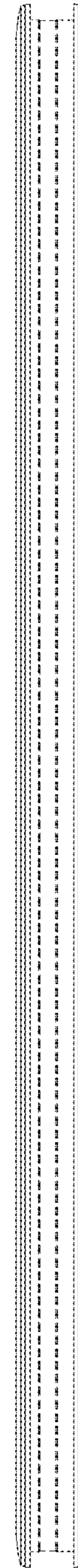

FIG. 17

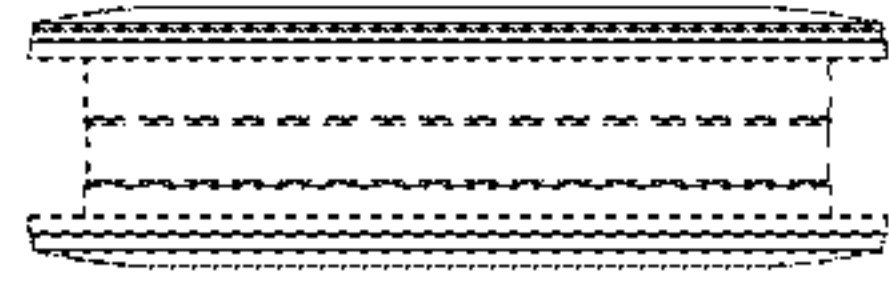

FIG. 18

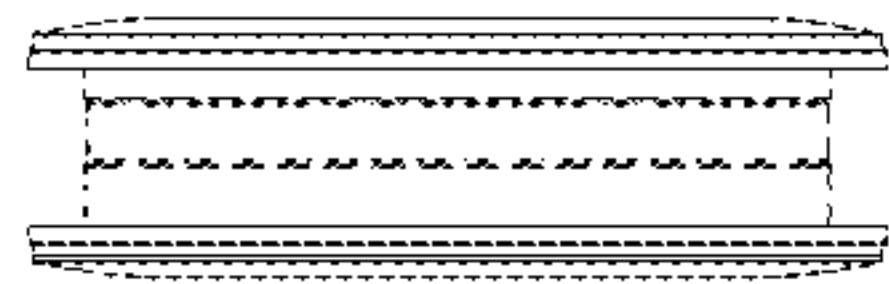

FIG. 19

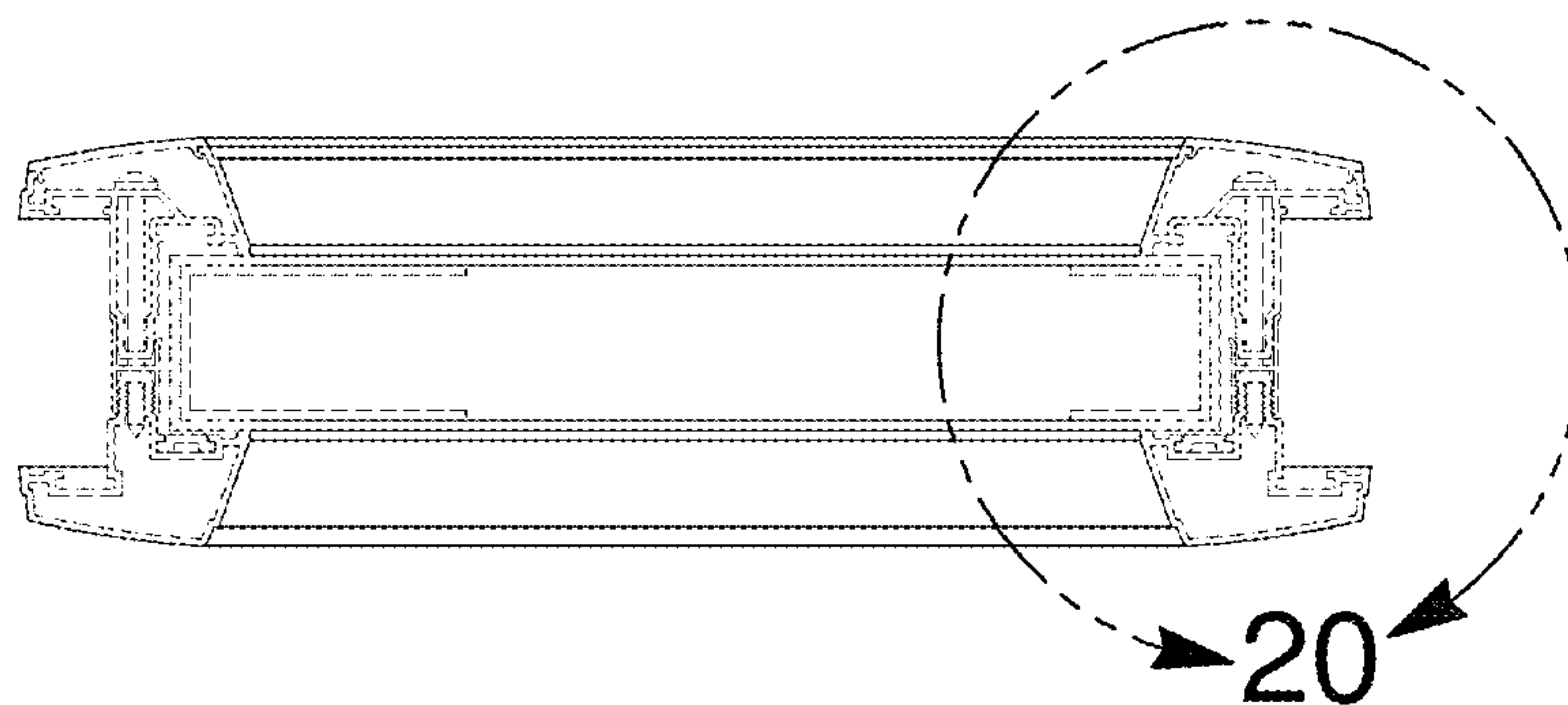

FIG. 20

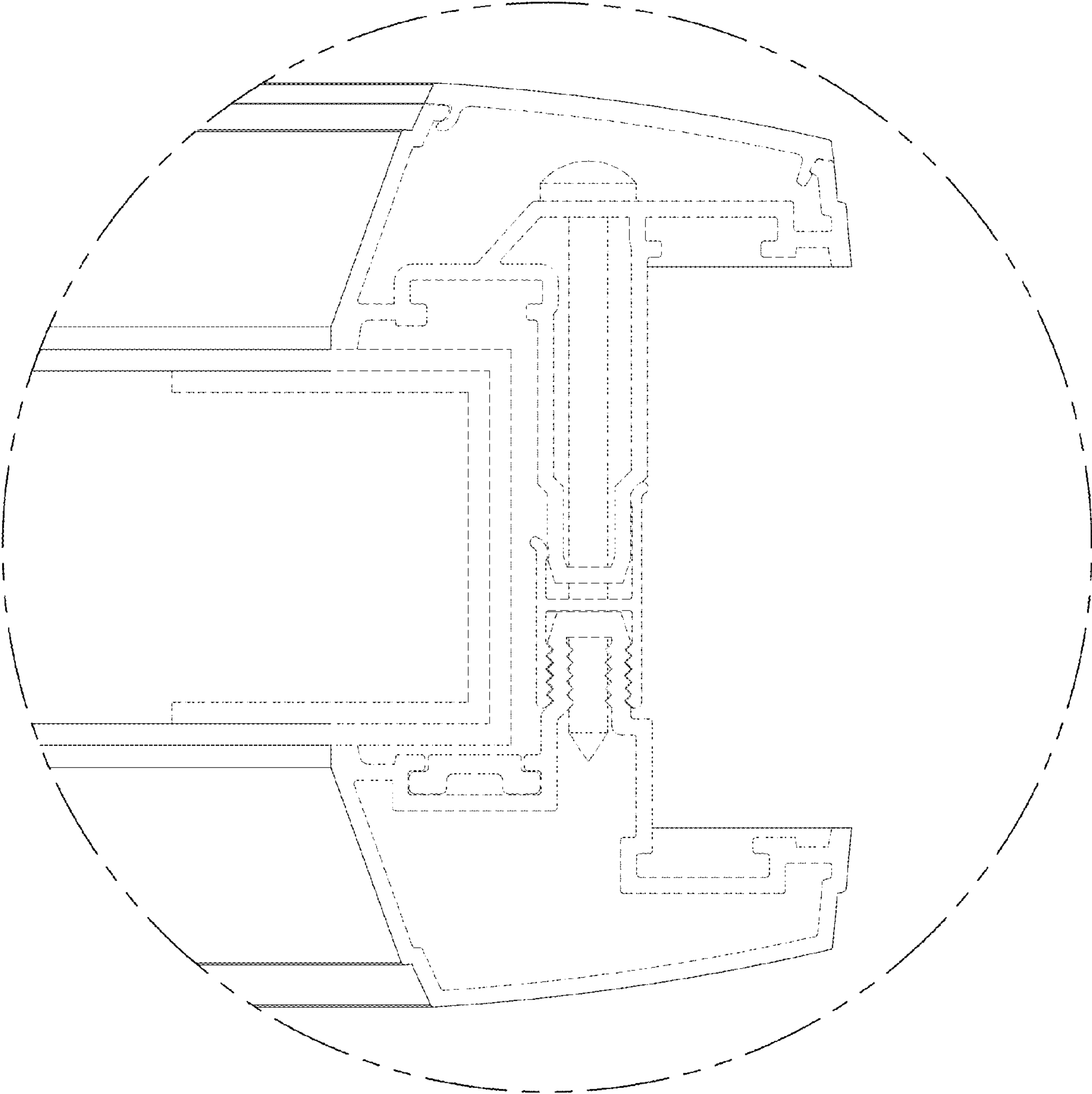

FIG. 21

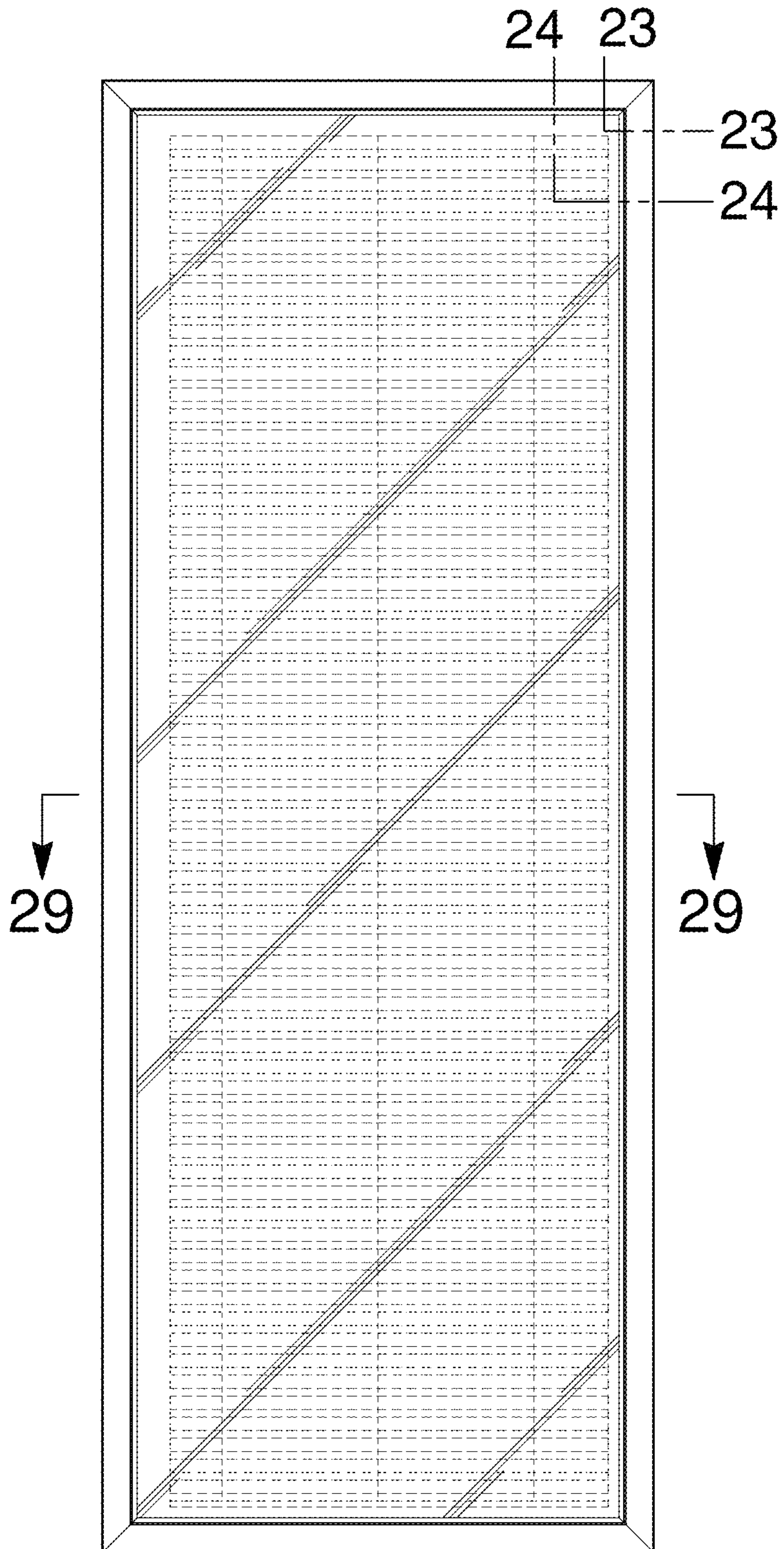

FIG. 22

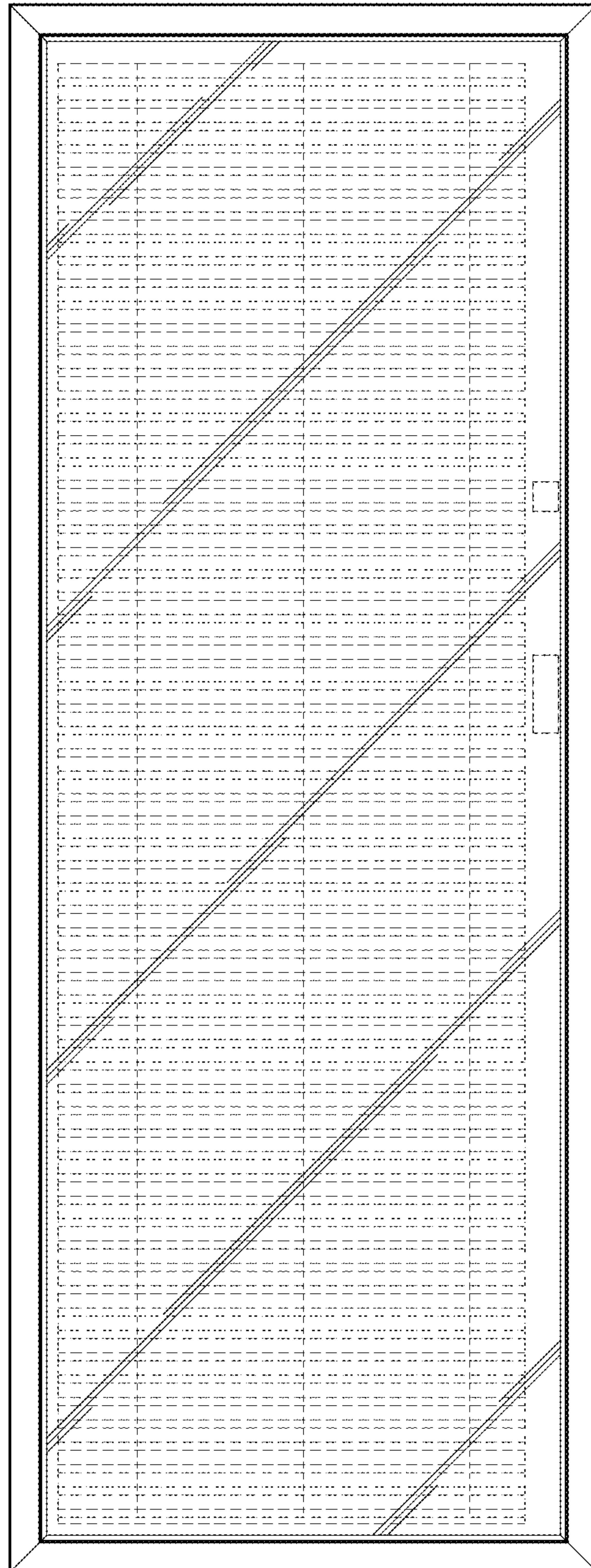

FIG. 23

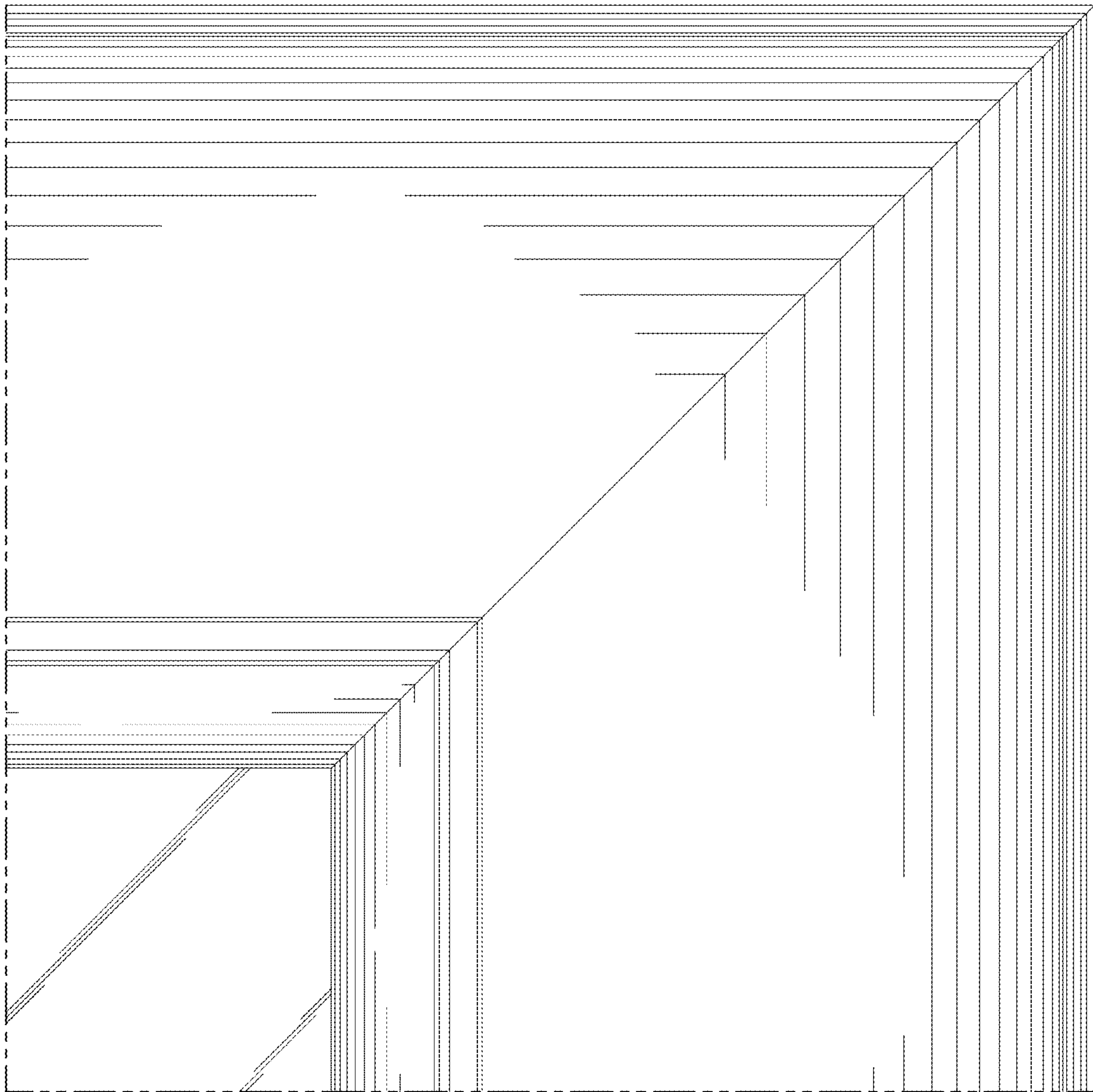

FIG. 24

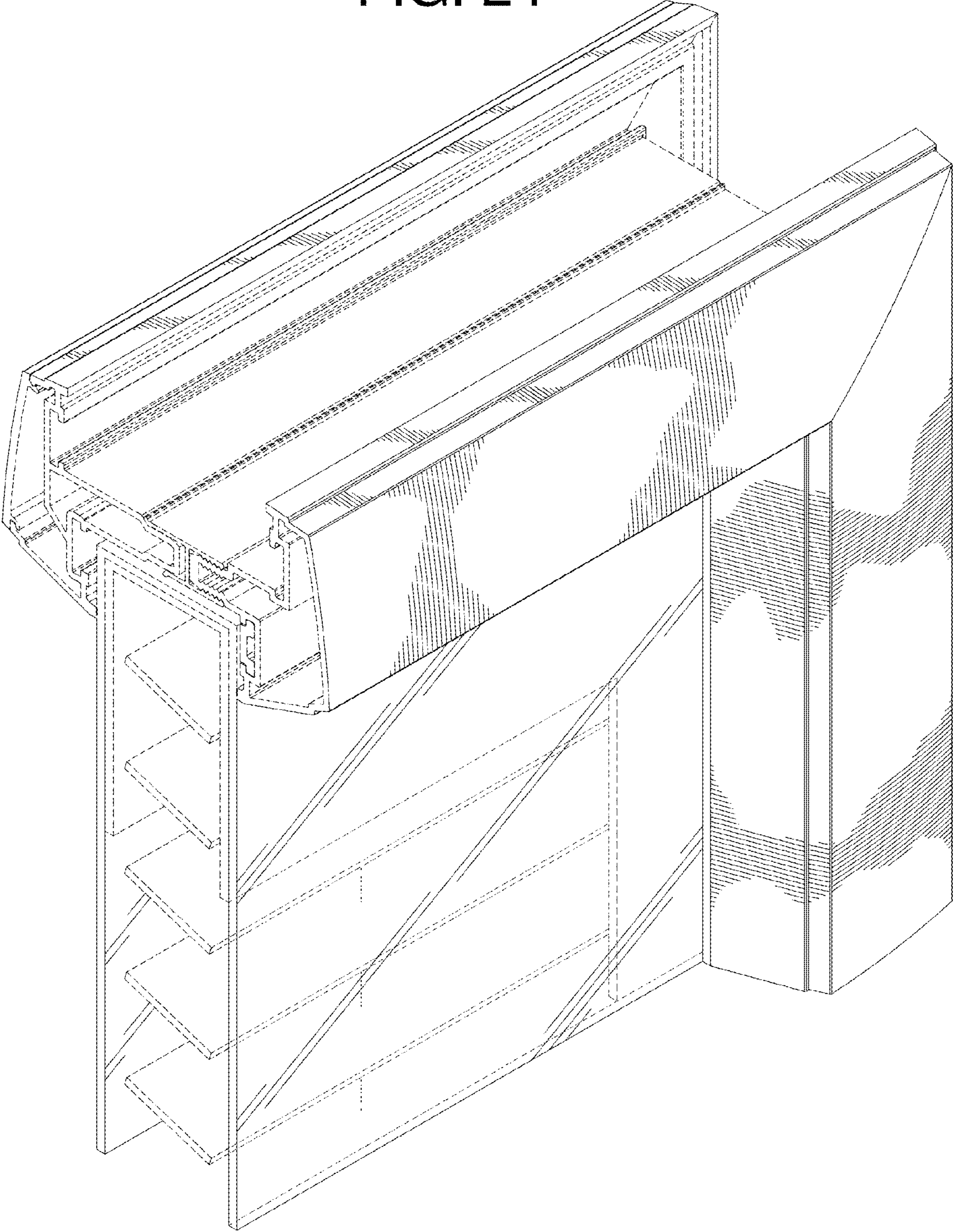

FIG. 25

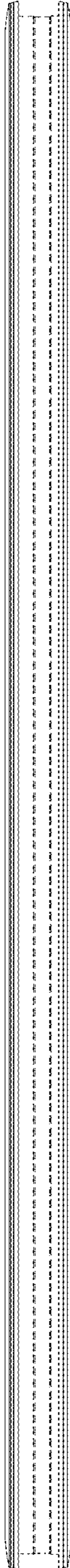

FIG. 26

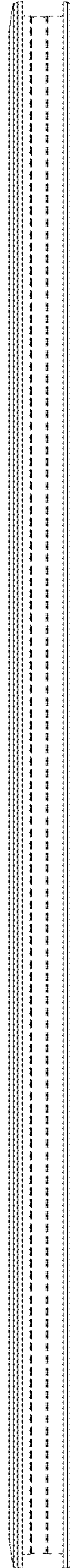

FIG. 27



FIG. 28



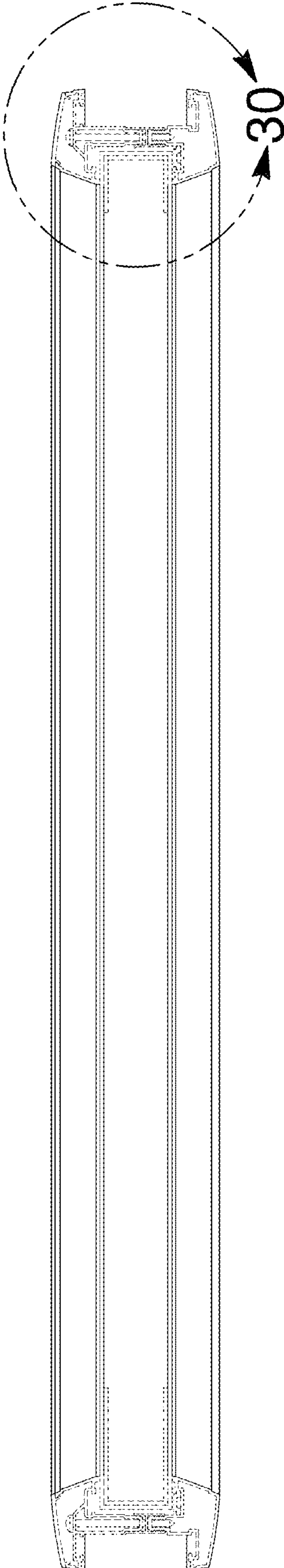

FIG. 29

FIG. 30

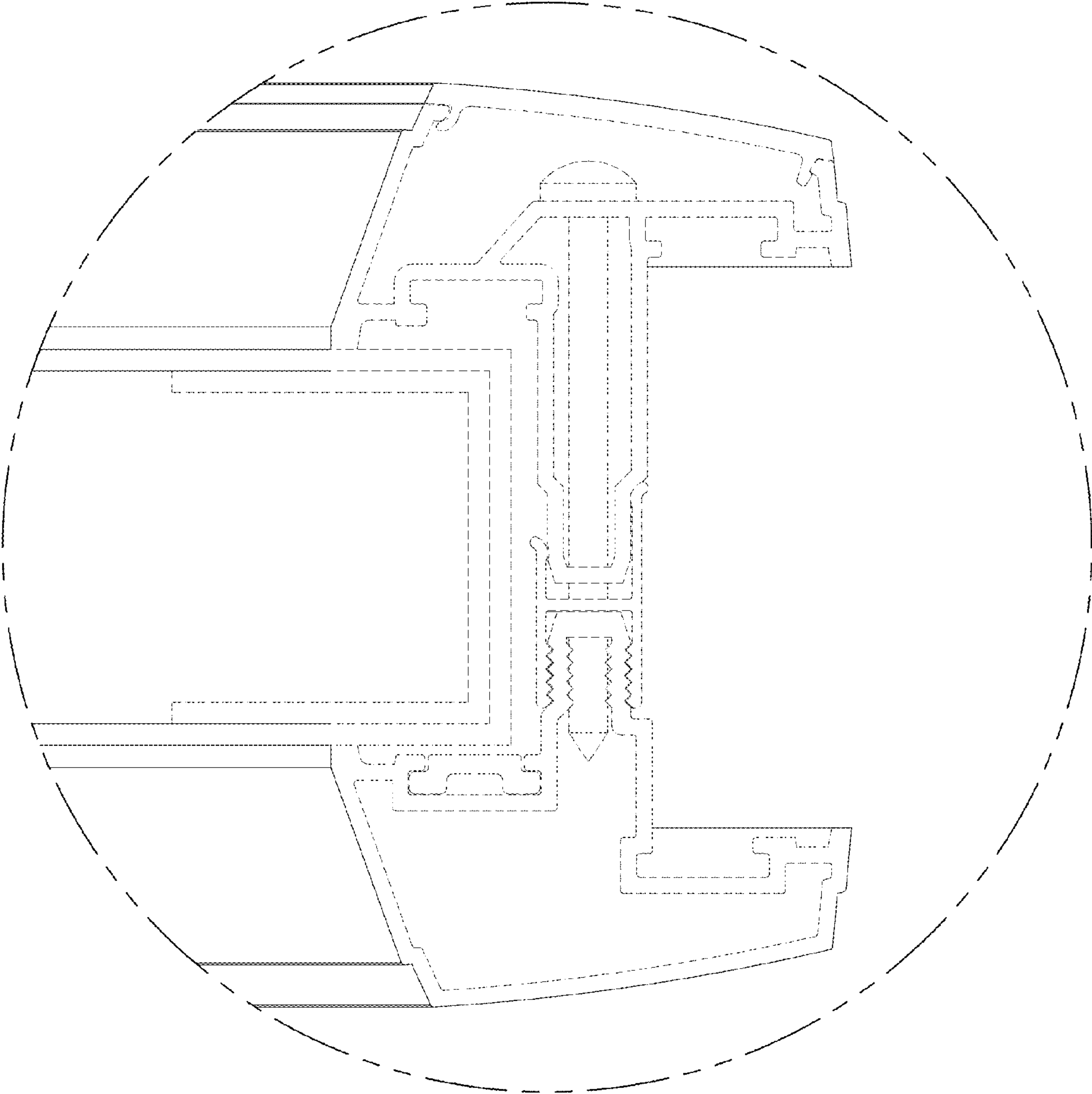

FIG. 31

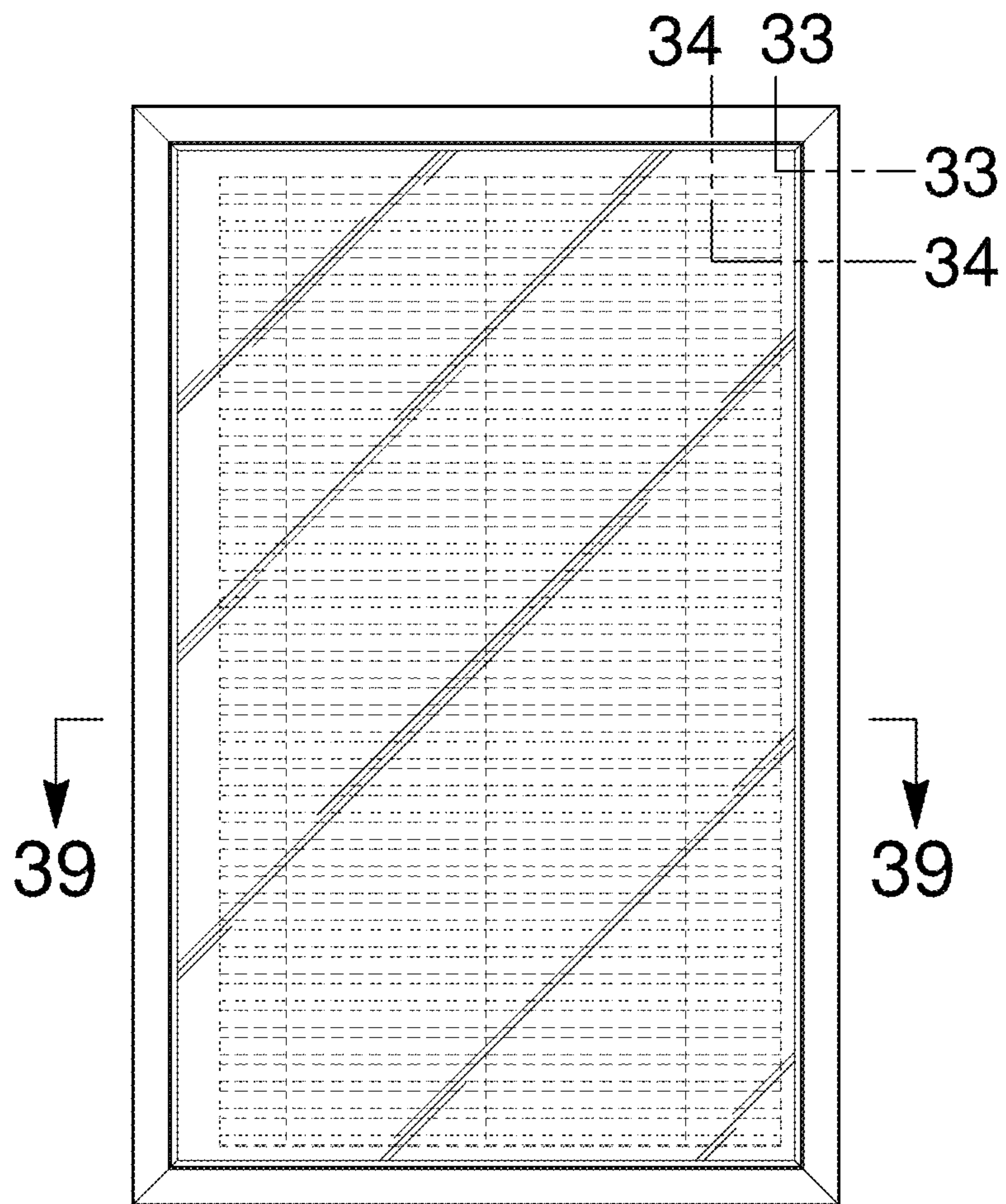

FIG. 32

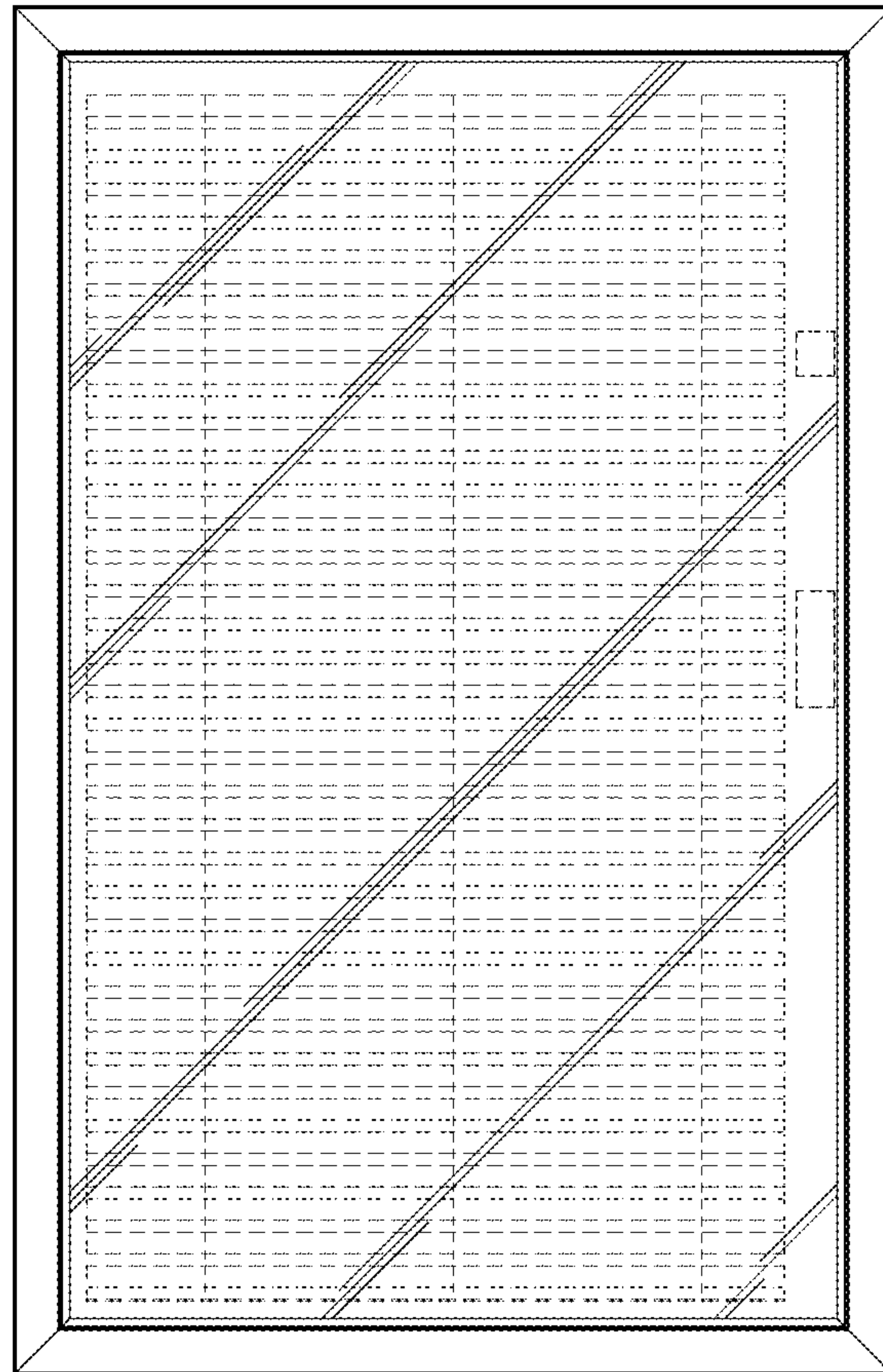

FIG. 33

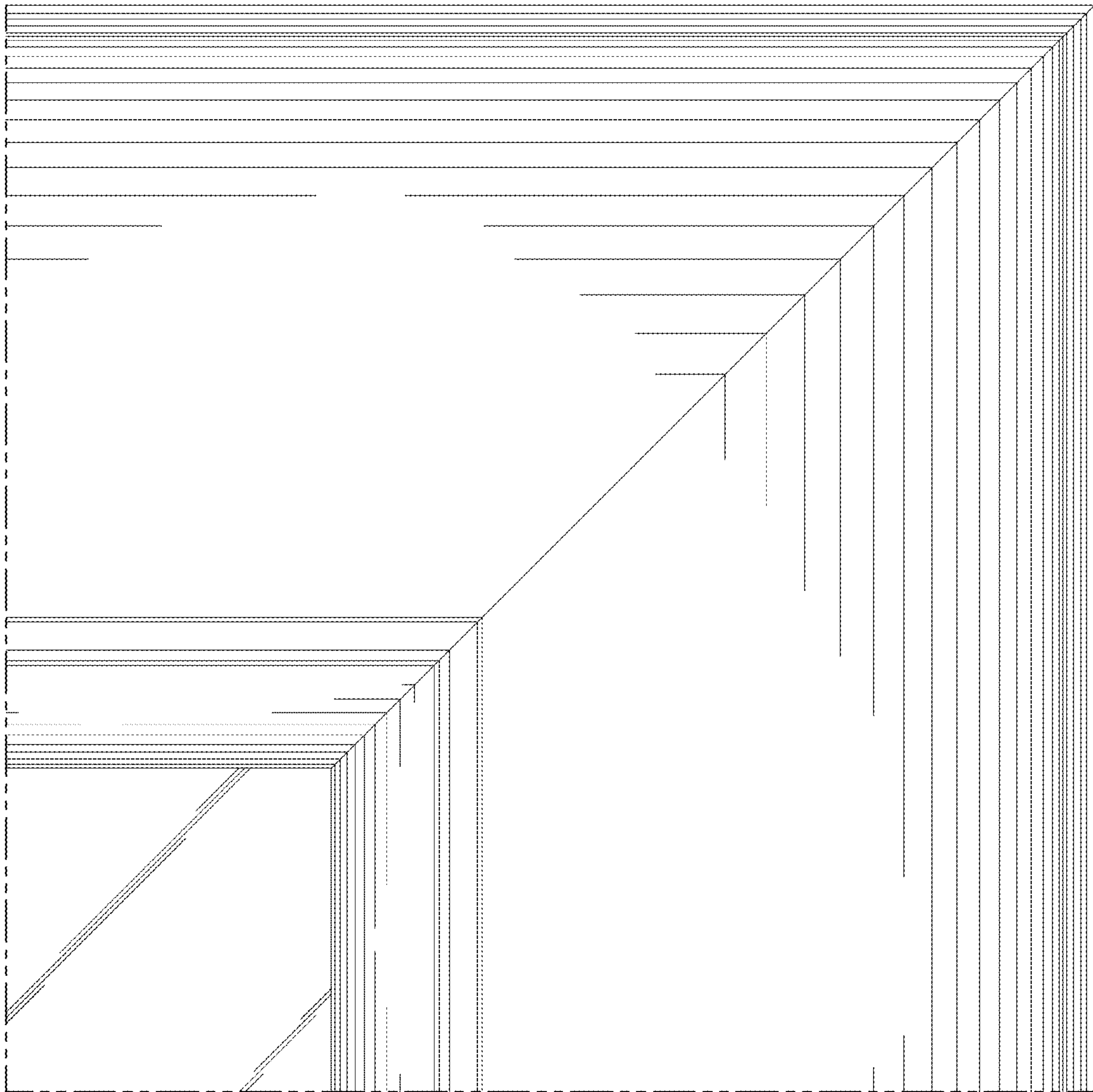

FIG. 34

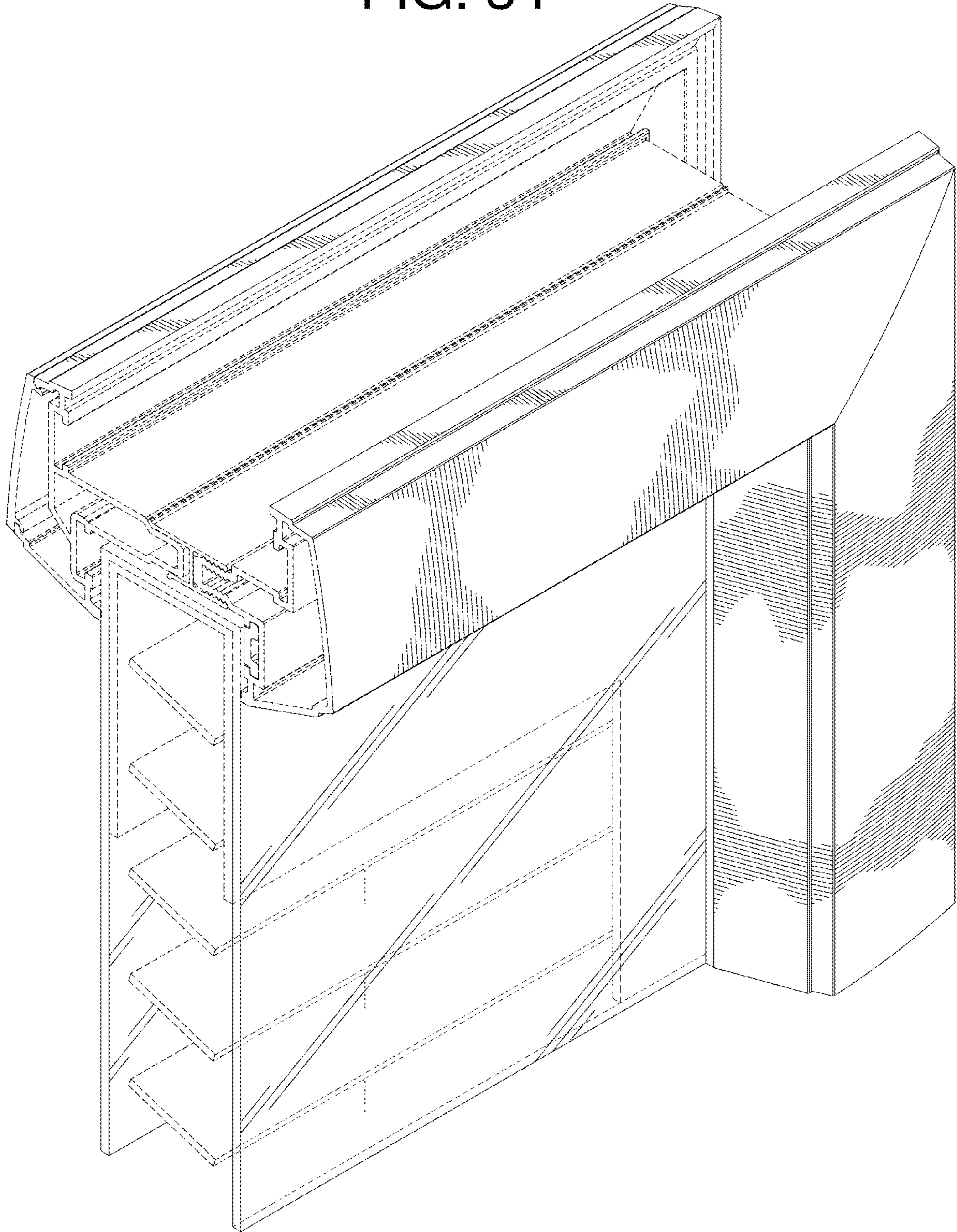

FIG. 35

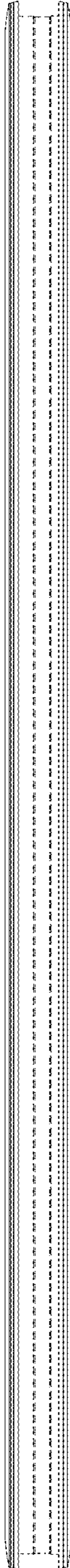

FIG. 36

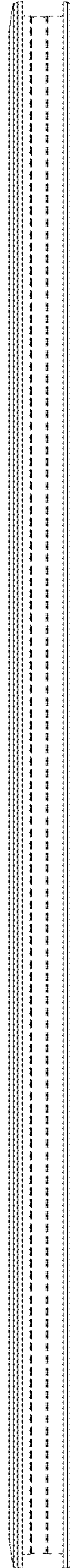

FIG. 37



FIG. 38



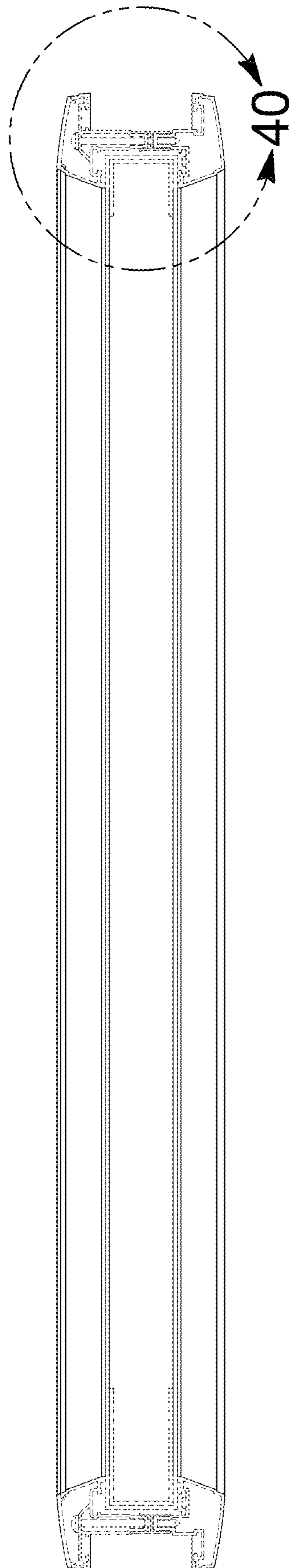

FIG. 39

FIG. 40

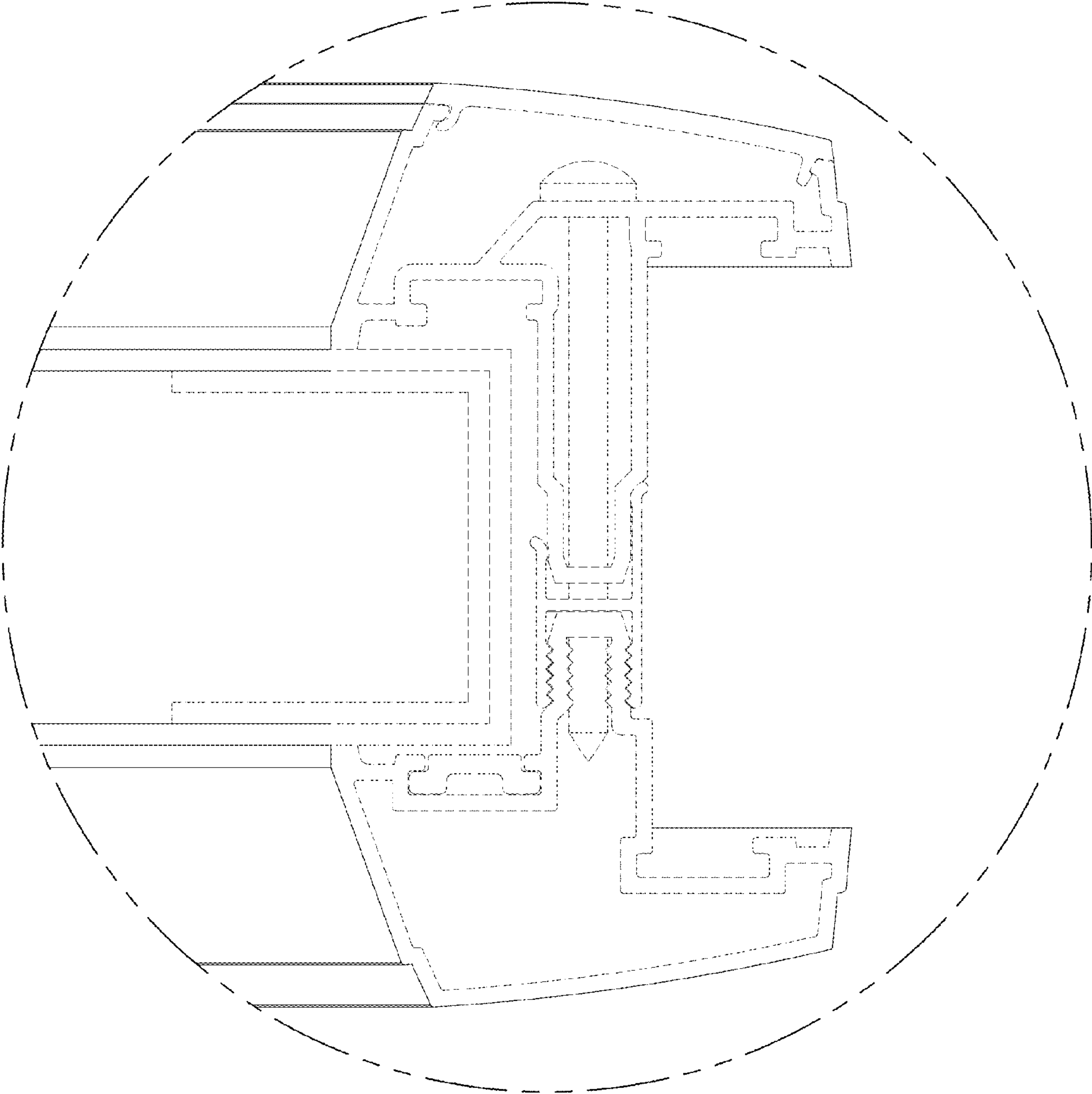

FIG. 41

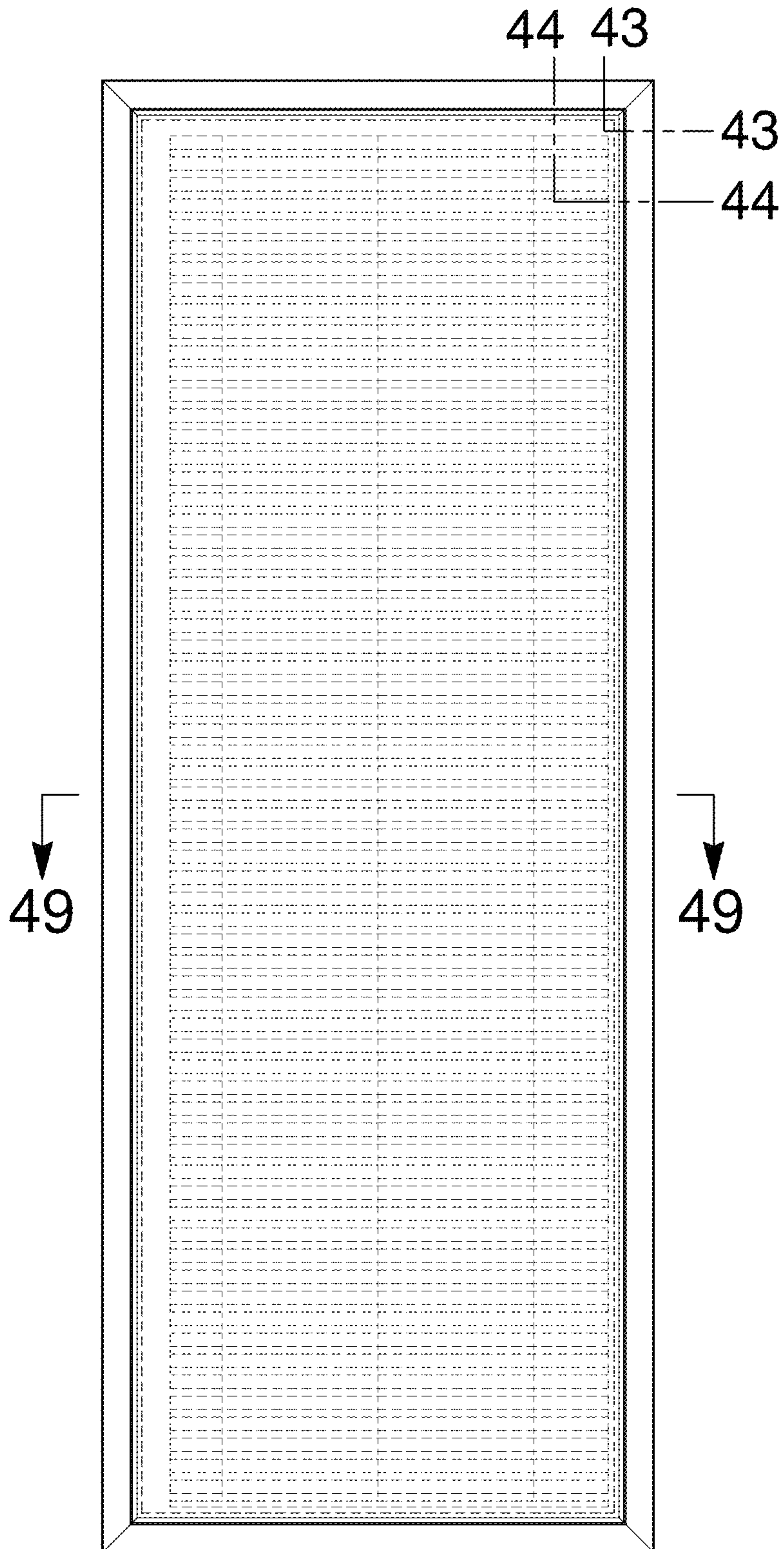

FIG. 42

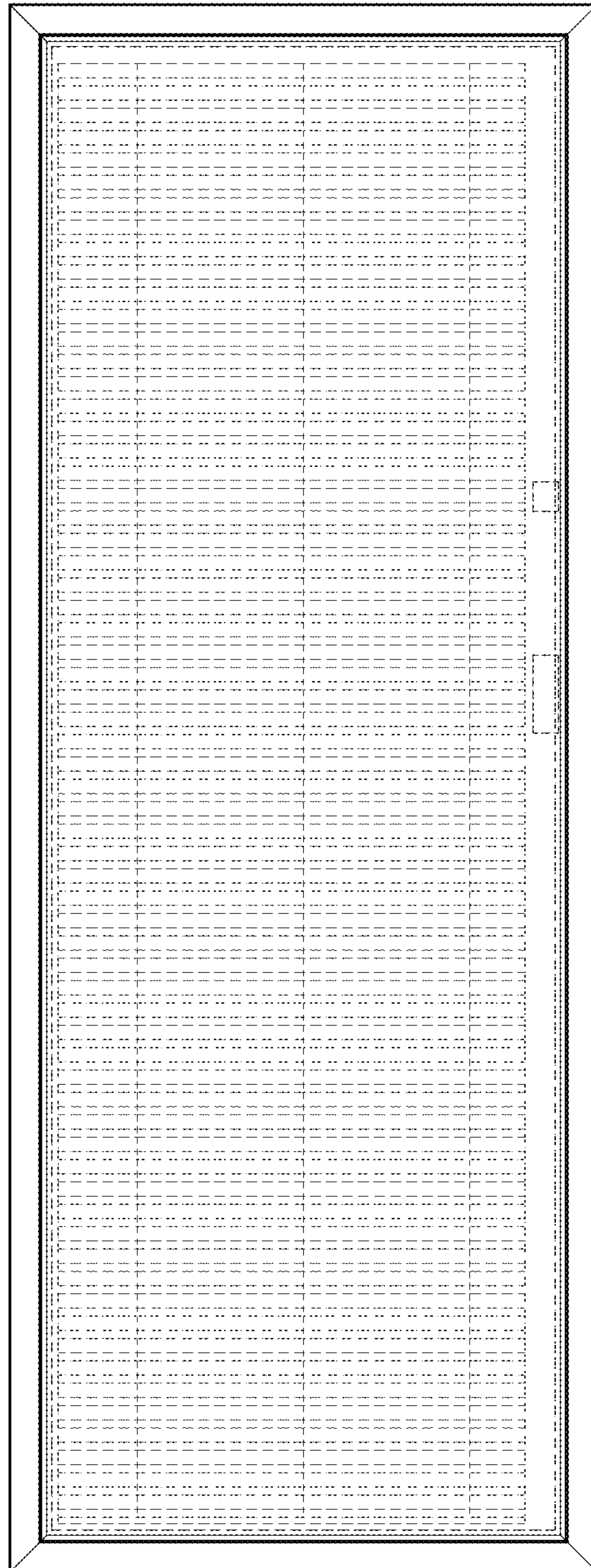

FIG. 43

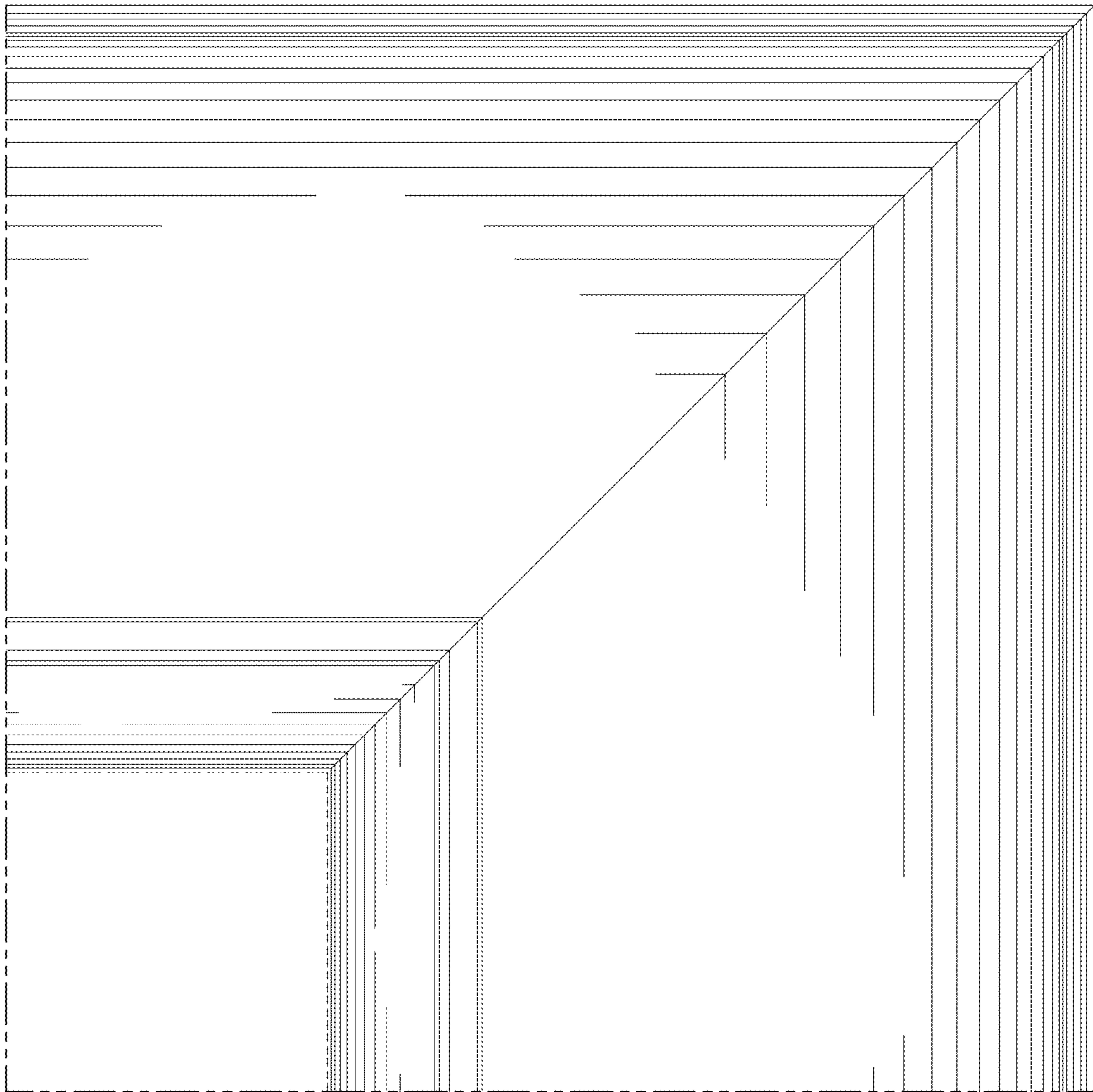

FIG. 44

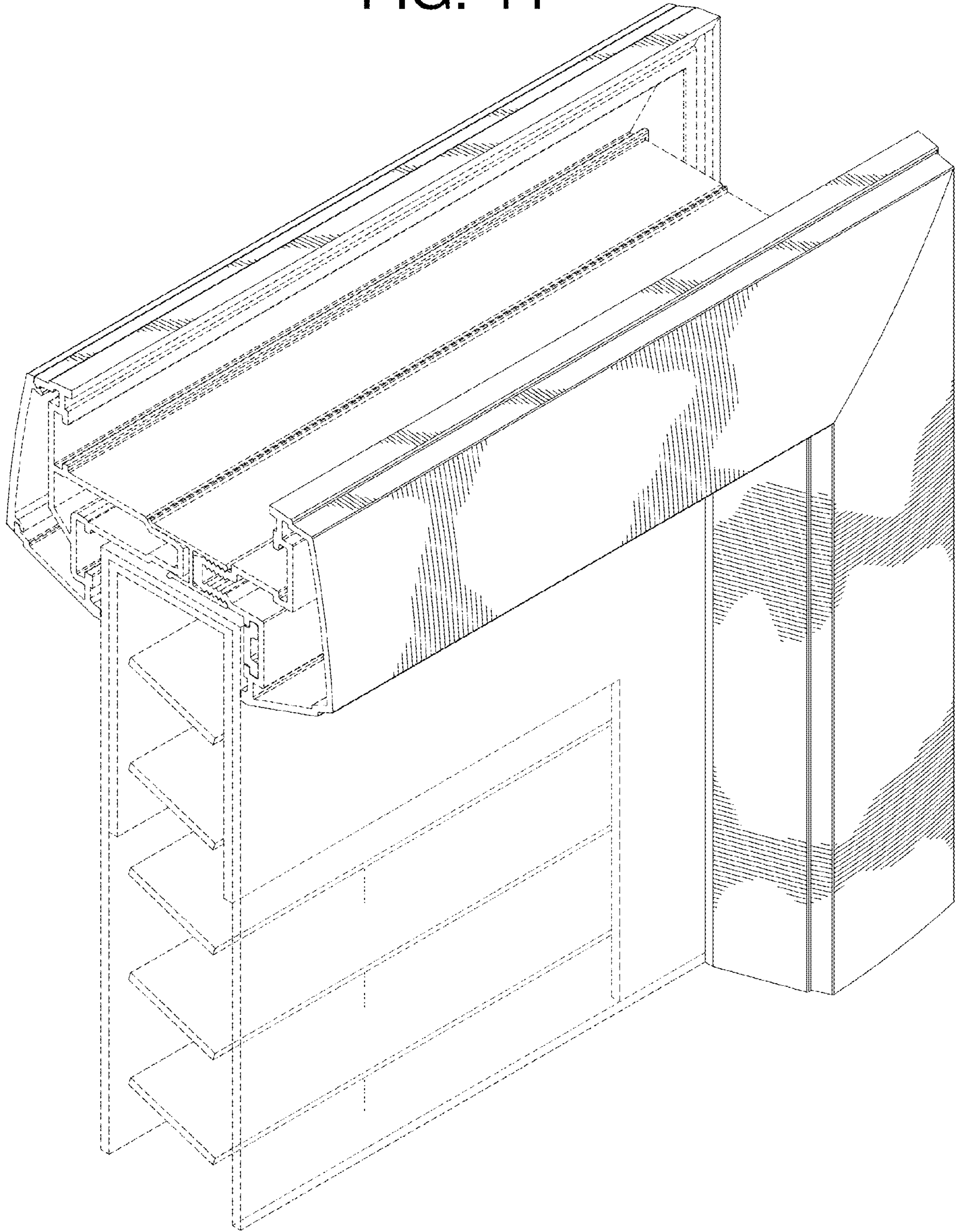

FIG. 45

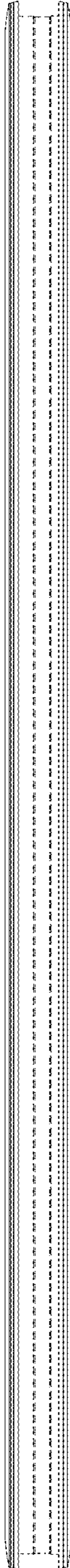

FIG. 46

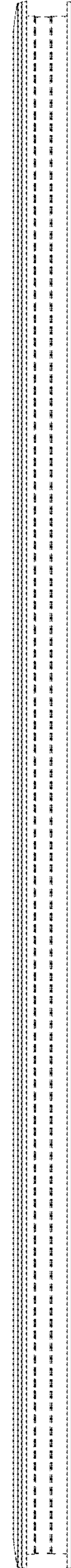

FIG. 47



FIG. 48



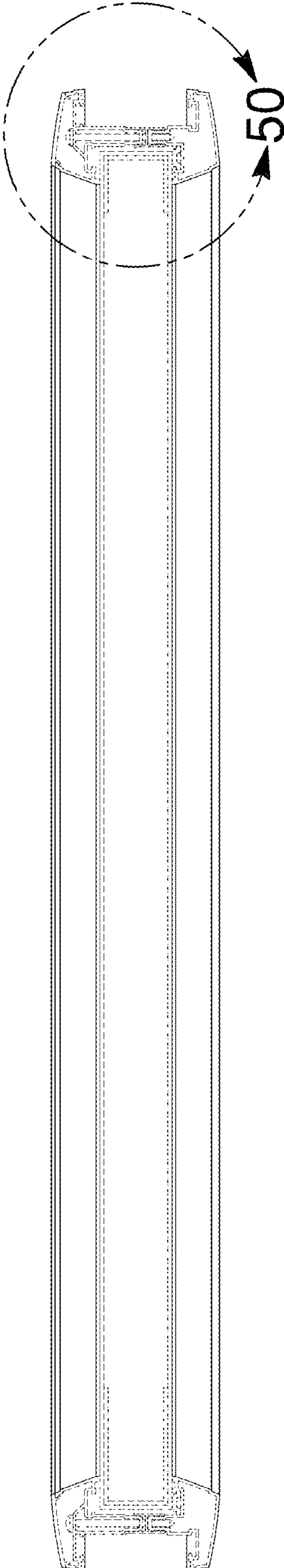

FIG. 49

FIG. 50

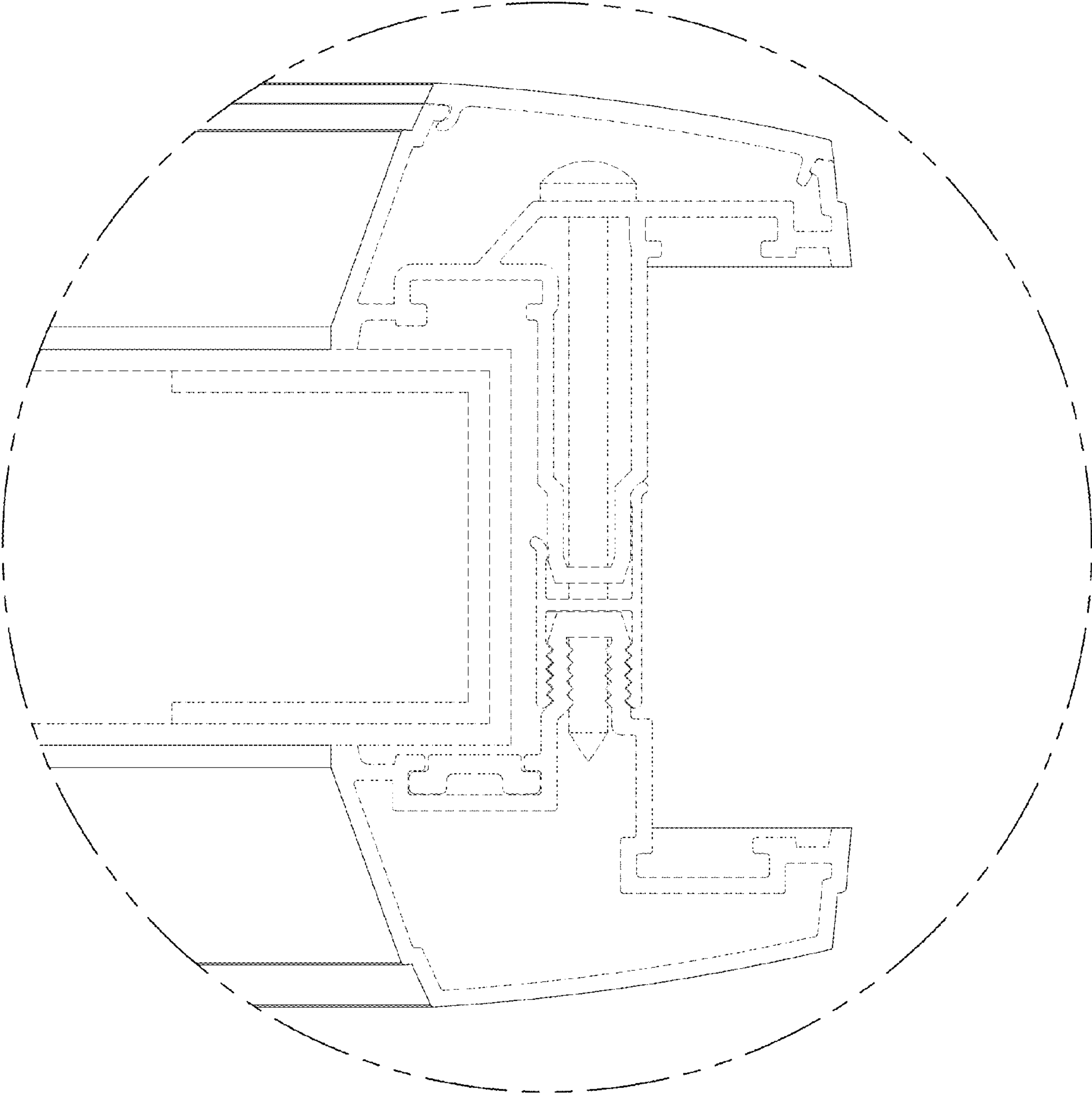

FIG. 51

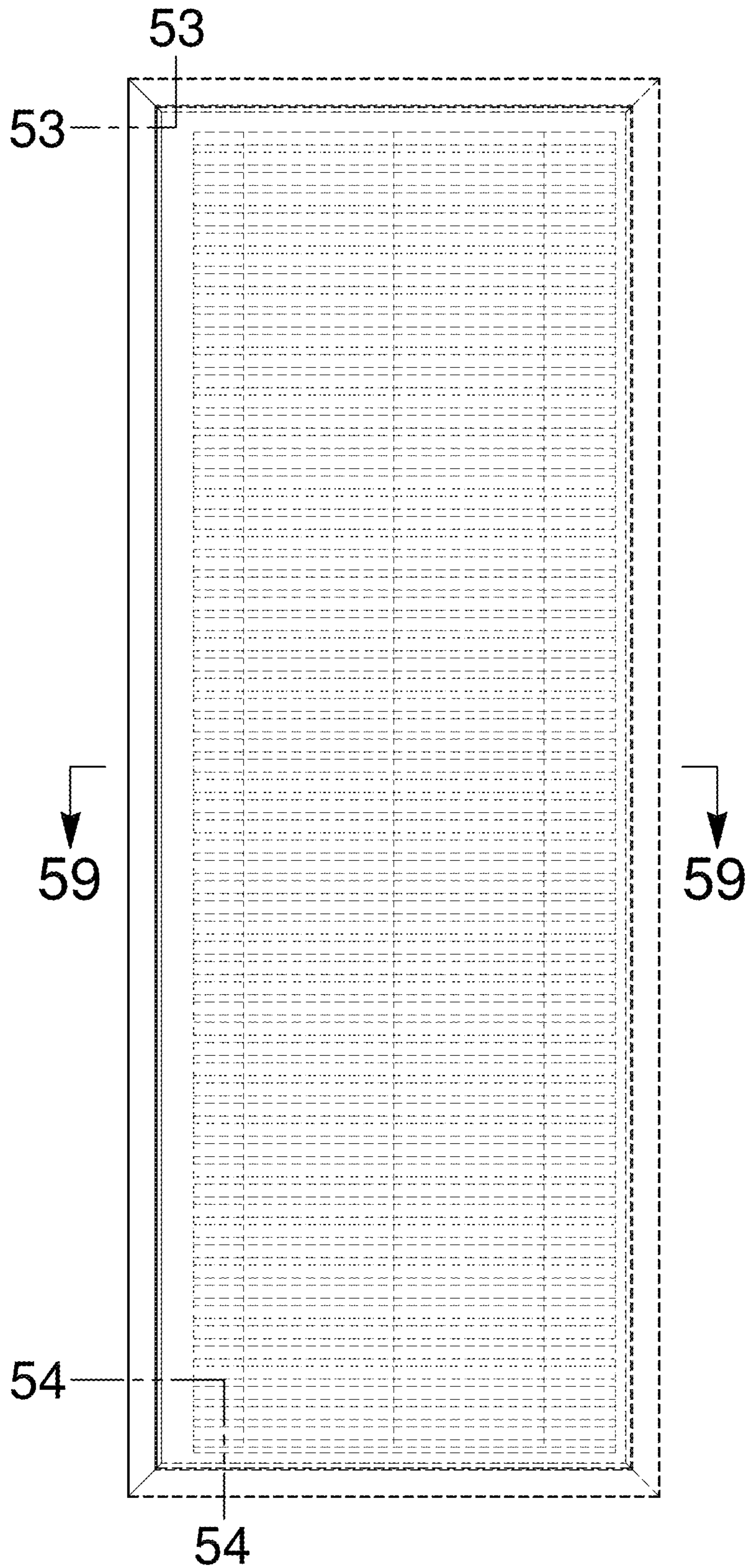

FIG. 52

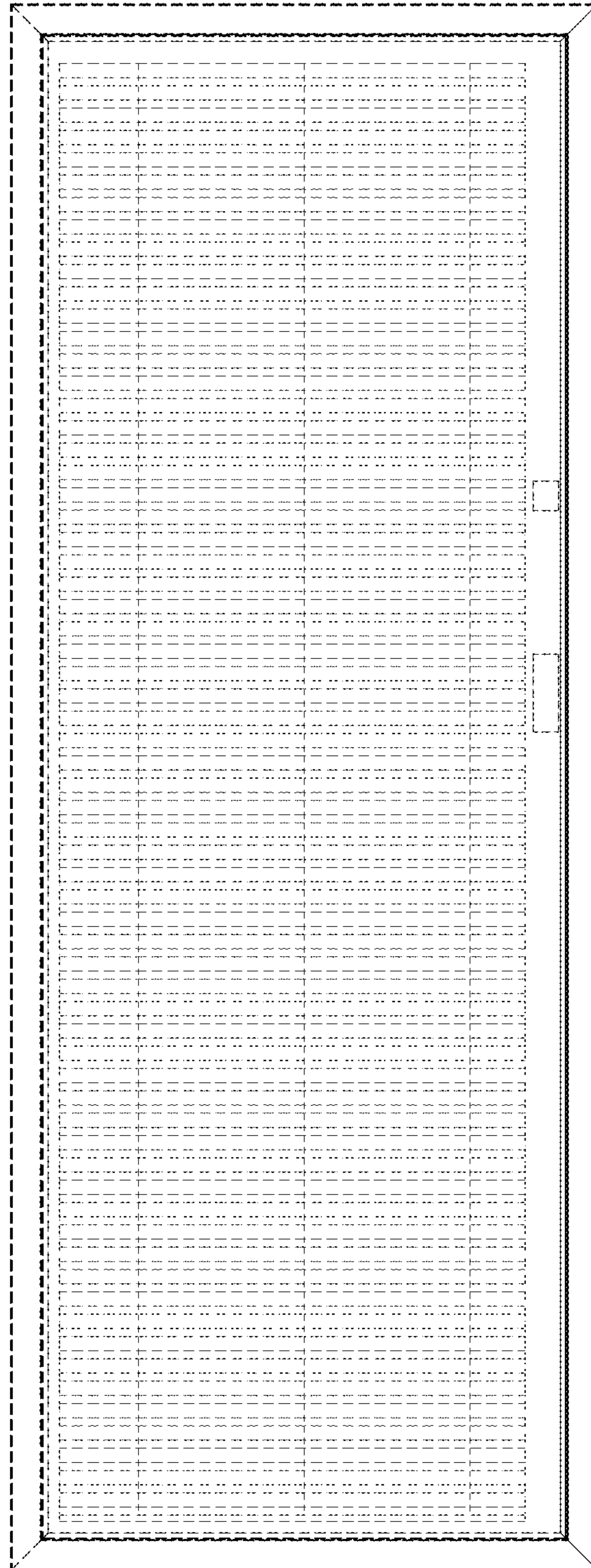

FIG. 53

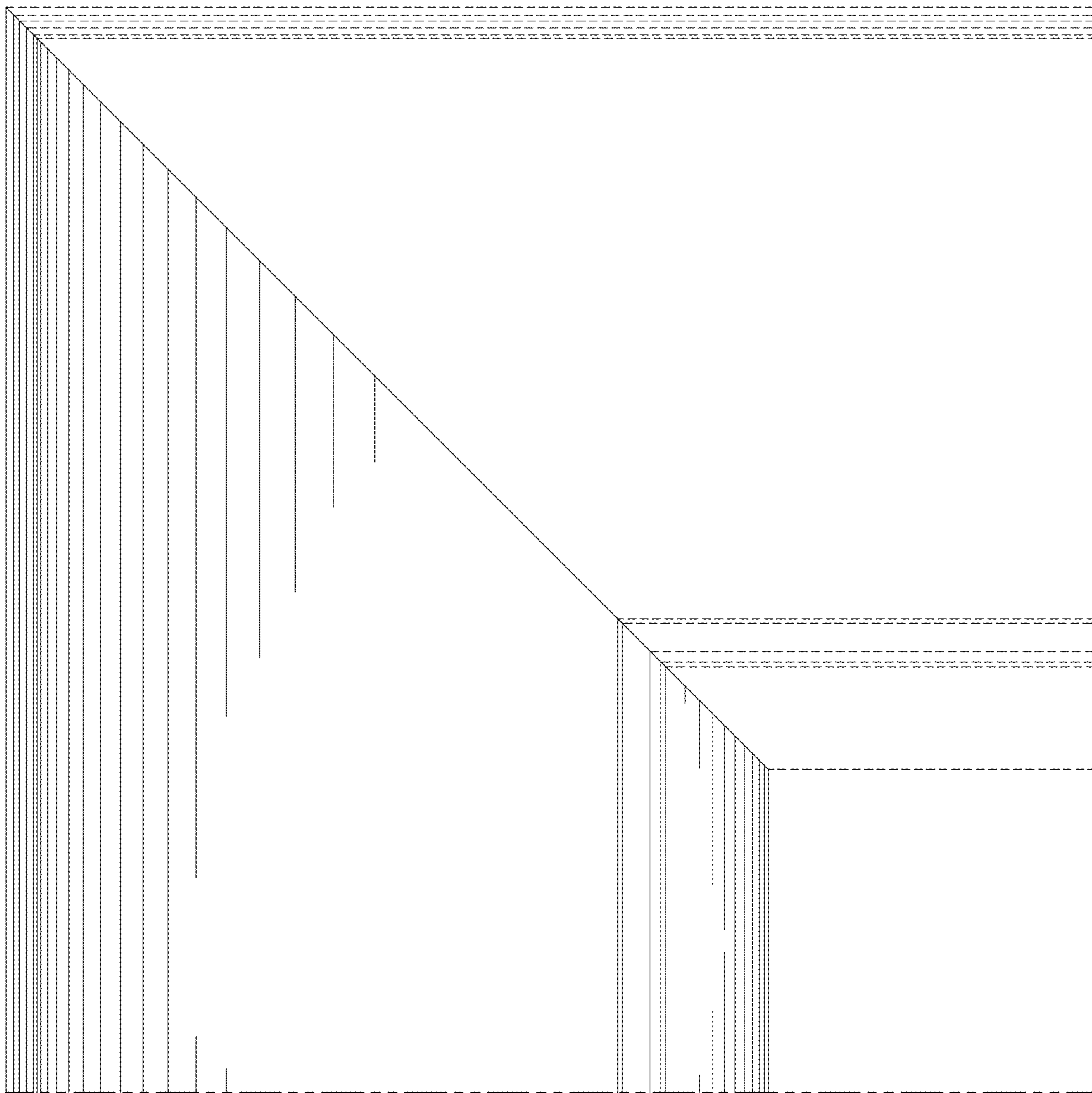

FIG. 54

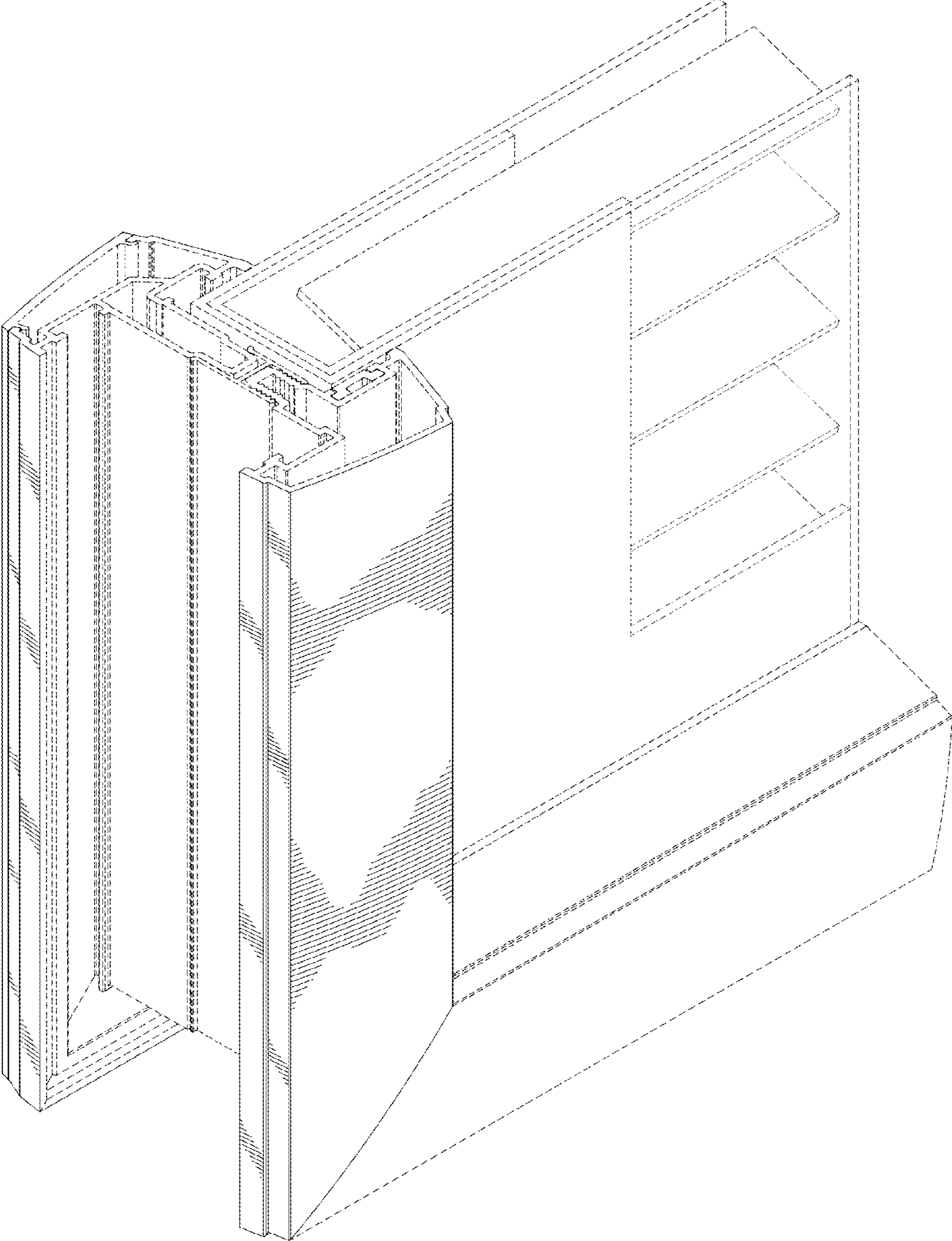

FIG. 55

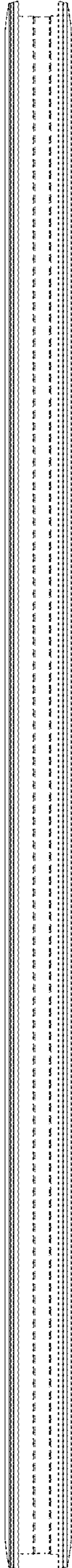

FIG. 56



FIG. 57

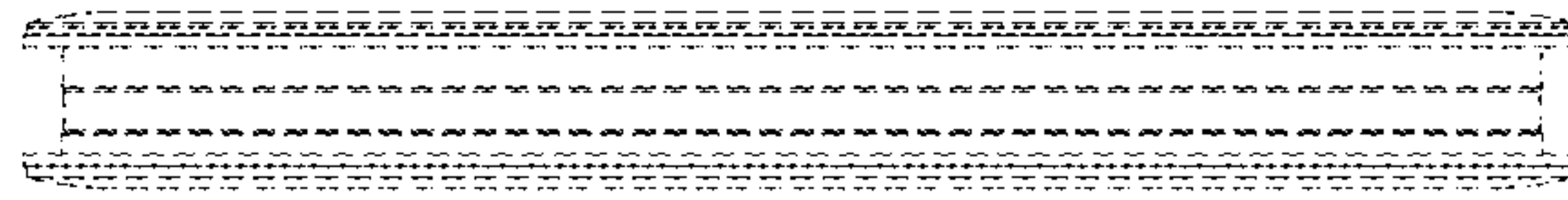

FIG. 58

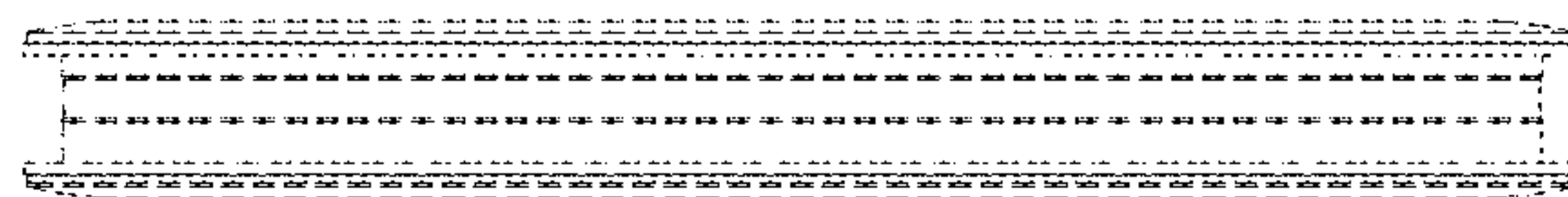

FIG. 59

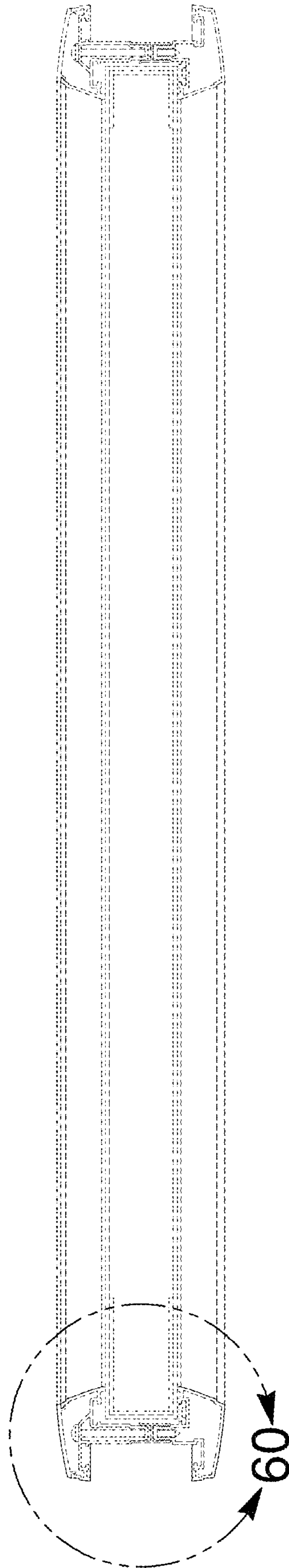

FIG. 60

