



US00D929029S

(12) **United States Design Patent**  
**Findling**

(10) **Patent No.:** **US D929,029 S**

(45) **Date of Patent:** **\*\* Aug. 24, 2021**

(54) **WICK HOLDER**

(71) Applicant: **Keith Findling**, Salt Lake City, UT  
(US)

(72) Inventor: **Keith Findling**, Salt Lake City, UT  
(US)

(\*\*) Term: **15 Years**

(21) Appl. No.: **29/665,432**

(22) Filed: **Oct. 3, 2018**

(51) **LOC (13) Cl.** ..... **26-99**

(52) **U.S. Cl.**  
USPC ..... **D26/117**

(58) **Field of Classification Search**  
USPC ..... D26/1-6, 113-116, 117, 118  
CPC ..... A01G 13/06; C11C 5/006; F21L 17/00;  
F23D 3/16; F23D 3/18; F21S 13/00;  
F21S 13/12  
See application file for complete search history.

(56) **References Cited**

**U.S. PATENT DOCUMENTS**

- 3,790,332 A \* 2/1974 Woollard ..... F21S 13/12  
431/126
- 4,110,066 A \* 8/1978 Murphy ..... F21S 13/00  
431/125
- D280,938 S \* 10/1985 Sher ..... D26/110
- D355,266 S \* 2/1995 Caplette ..... D26/11
- D436,416 S \* 1/2001 Iu ..... D26/11

- D437,655 S \* 2/2001 Galtt ..... D26/11
- D437,656 S \* 2/2001 Galtt ..... D26/11
- D437,967 S \* 2/2001 Galtt ..... D26/11

\* cited by examiner

*Primary Examiner* — Zenia I Bennett

(74) *Attorney, Agent, or Firm* — David A. Jones; Nadesan Beck P.C.

(57) **CLAIM**

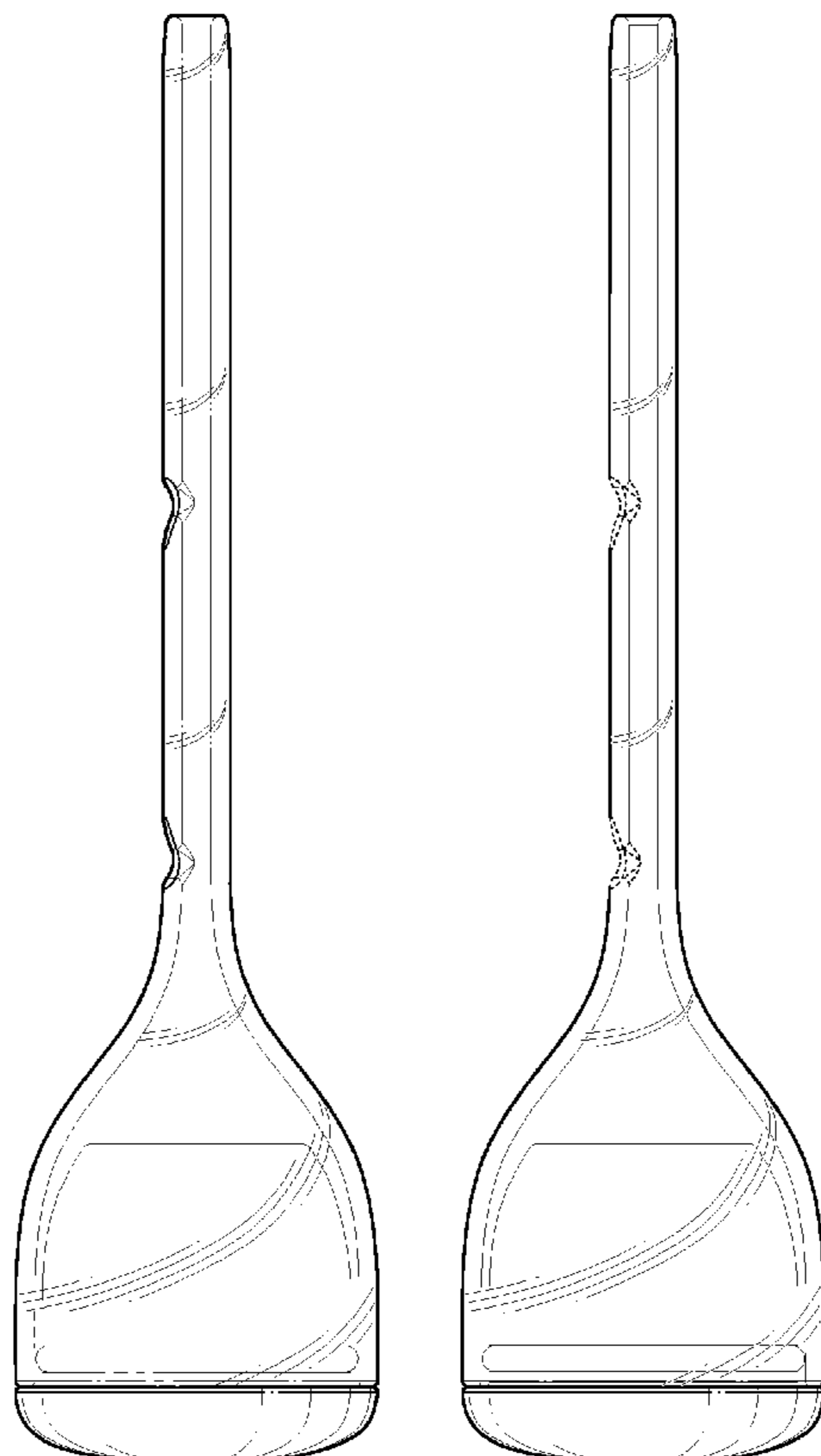
The ornamental design for a wick holder, as shown and described.

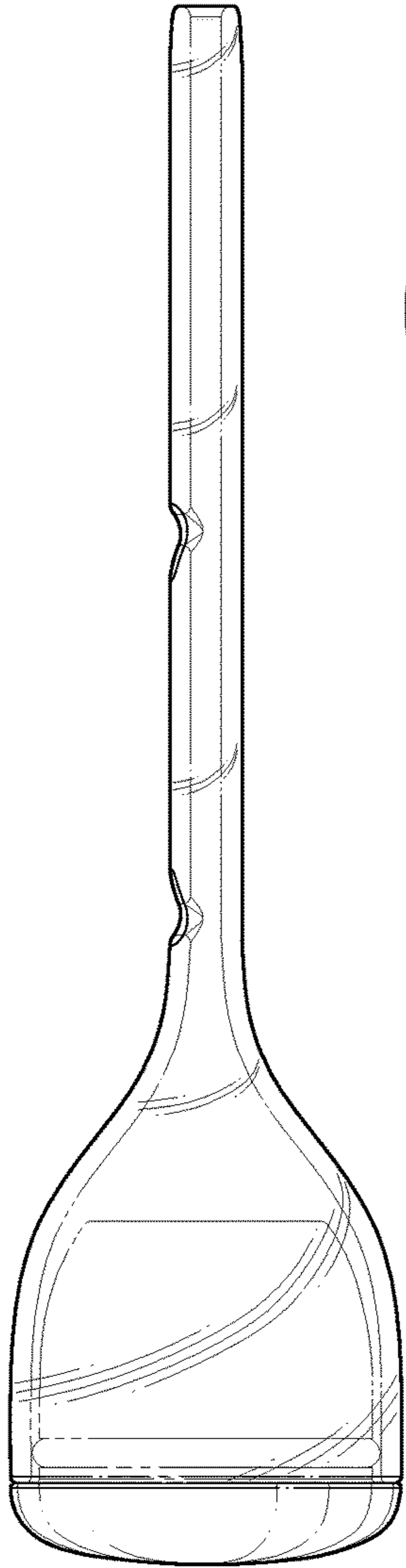
**DESCRIPTION**

FIG. 1 is a front perspective view of a wick holder in accordance with the present invention;  
 FIG. 2 is a front view thereof;  
 FIG. 3 is a left view thereof;  
 FIG. 4 is a right view thereof;  
 FIG. 5 is a top view thereof; and  
 FIG. 6 is a bottom view thereof;  
 FIG. 7 is a front perspective view of another embodiment of a wick holder in accordance with the present invention;  
 FIG. 8 is a front view thereof;  
 FIG. 9 is a left view thereof;  
 FIG. 10 is a right view thereof;  
 FIG. 11 is a top view thereof; and  
 FIG. 12 is a bottom view thereof.

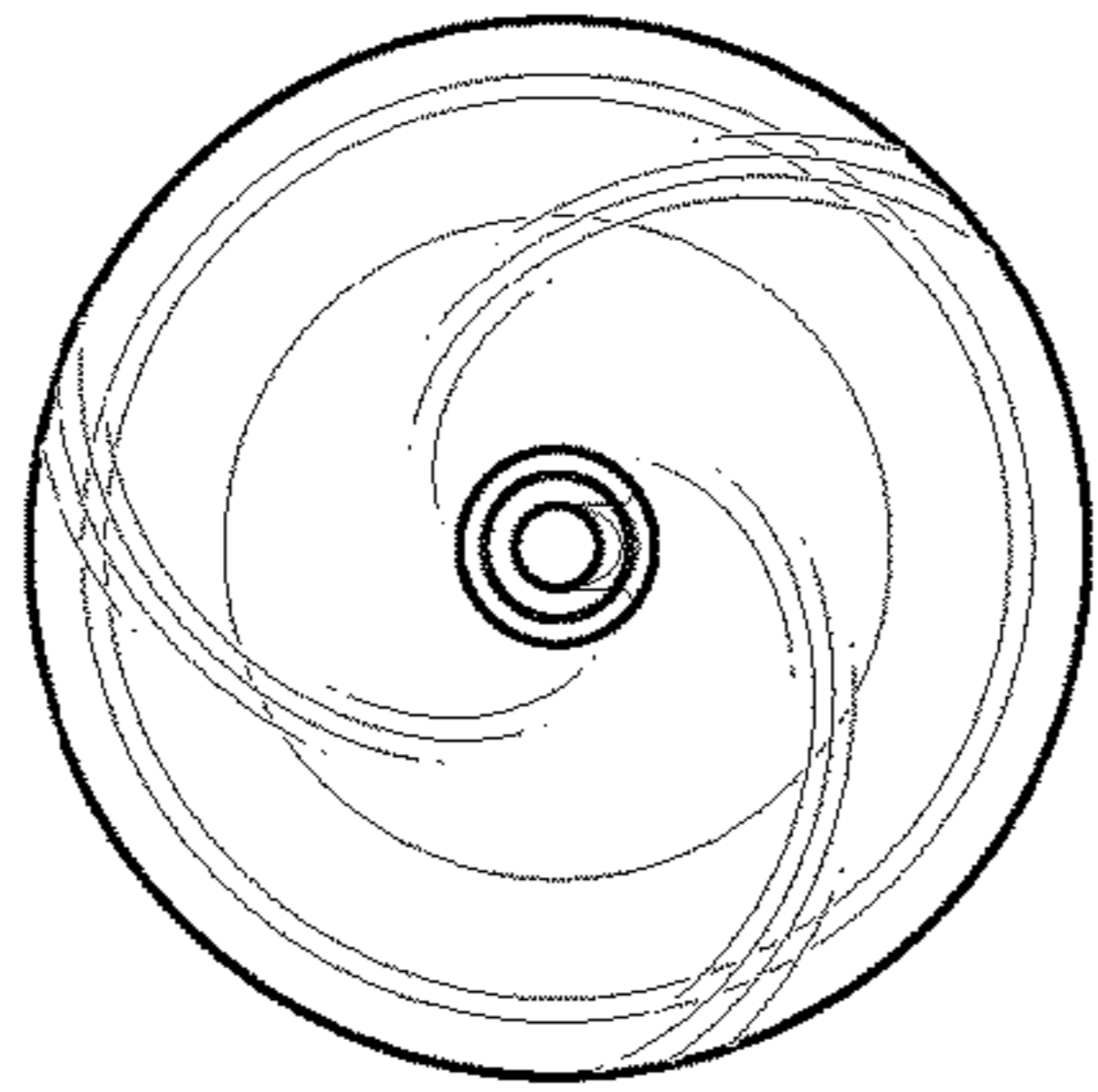
The features shown in broken lines in the various Figures are for illustrating environmental structure and form no part of the claimed design.

**1 Claim, 2 Drawing Sheets**

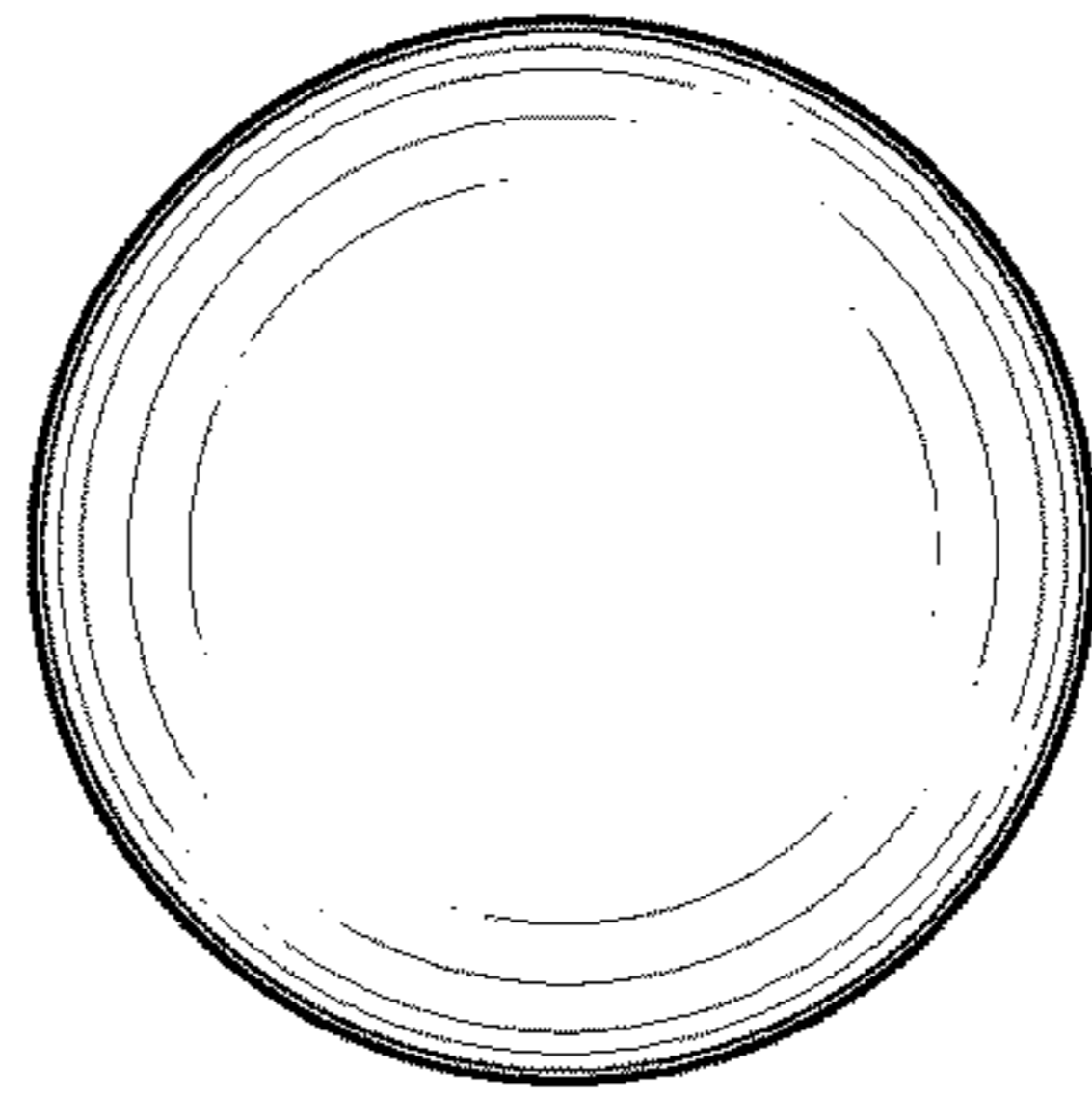




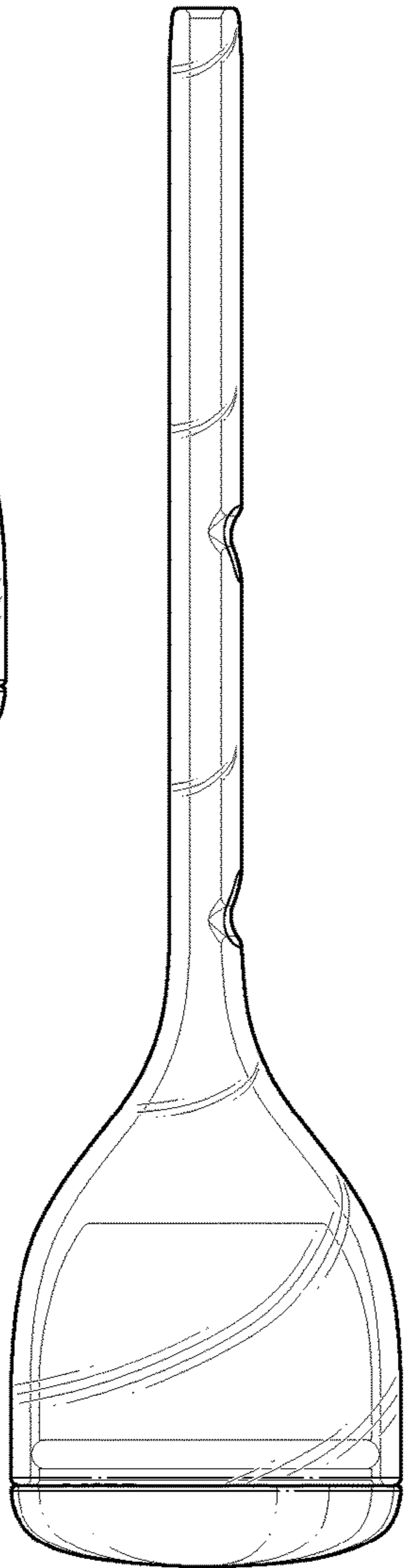
**FIG. 4**



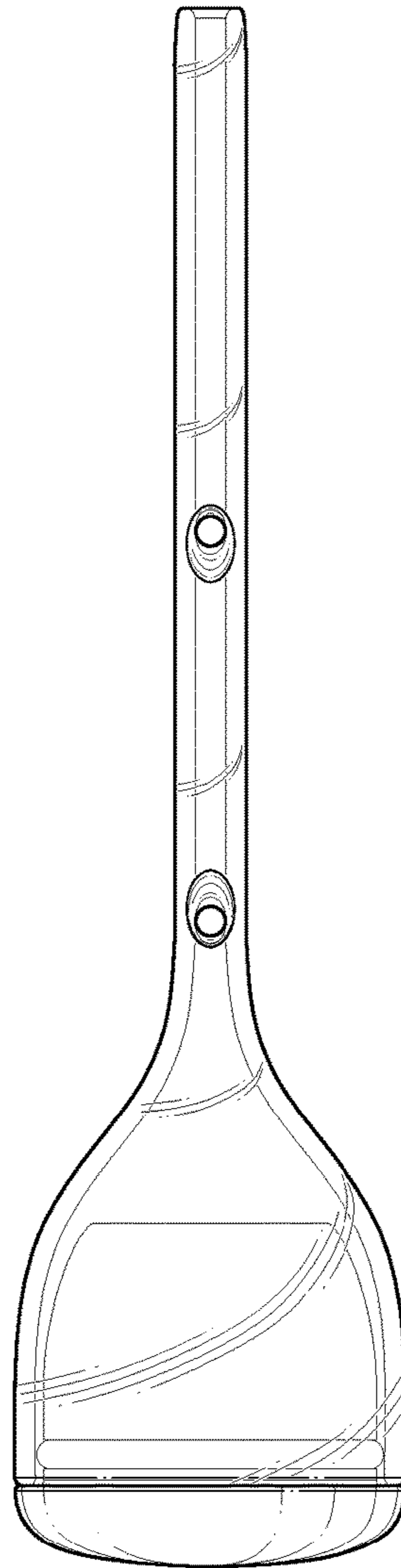
**FIG. 5**



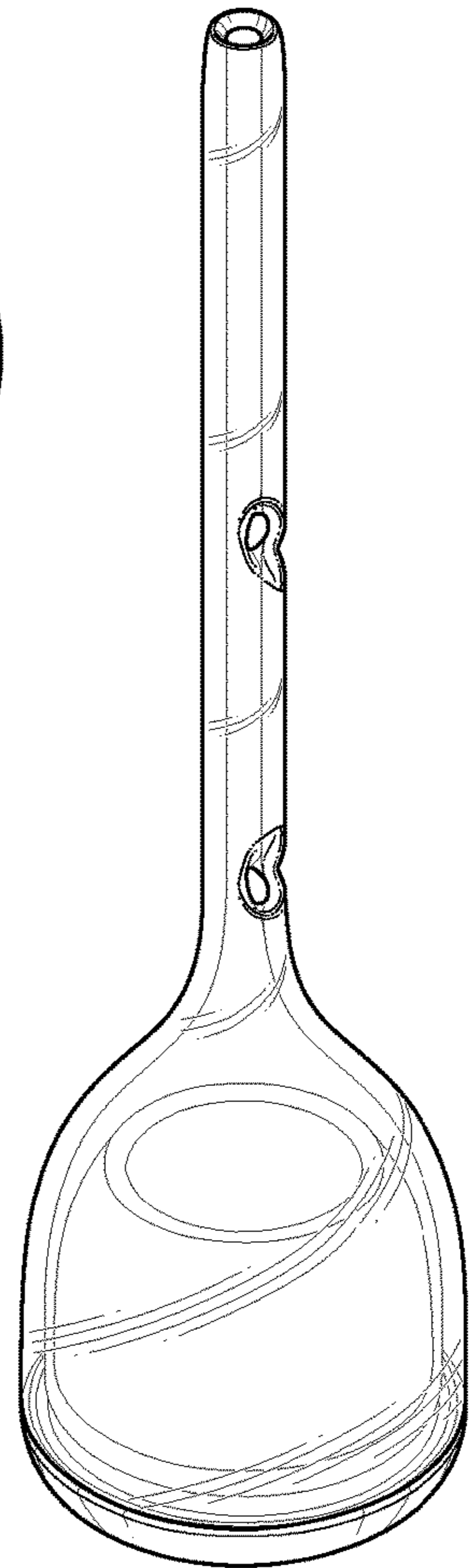
**FIG. 6**



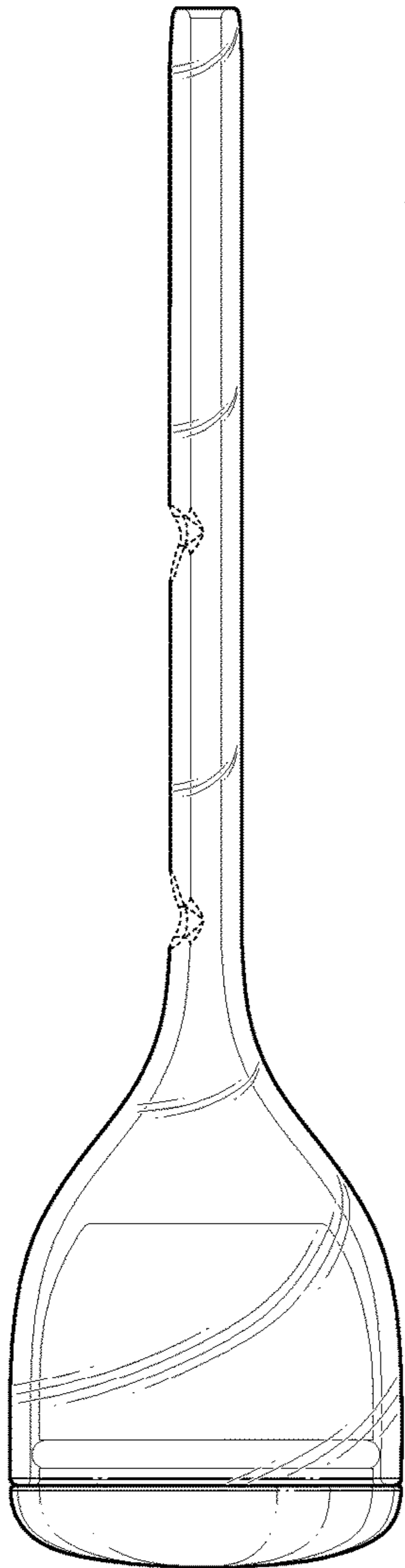
**FIG. 3**



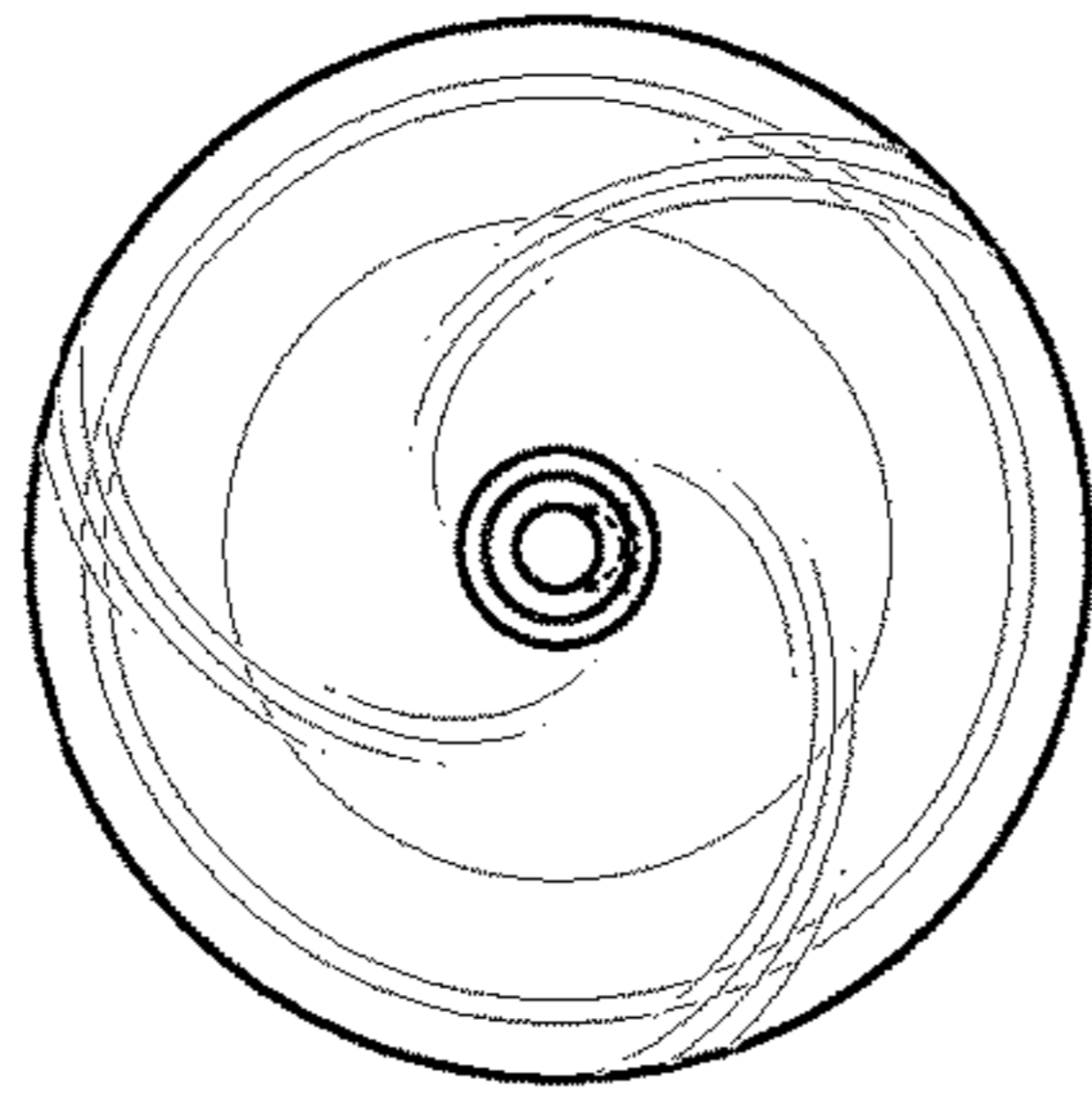
**FIG. 2**



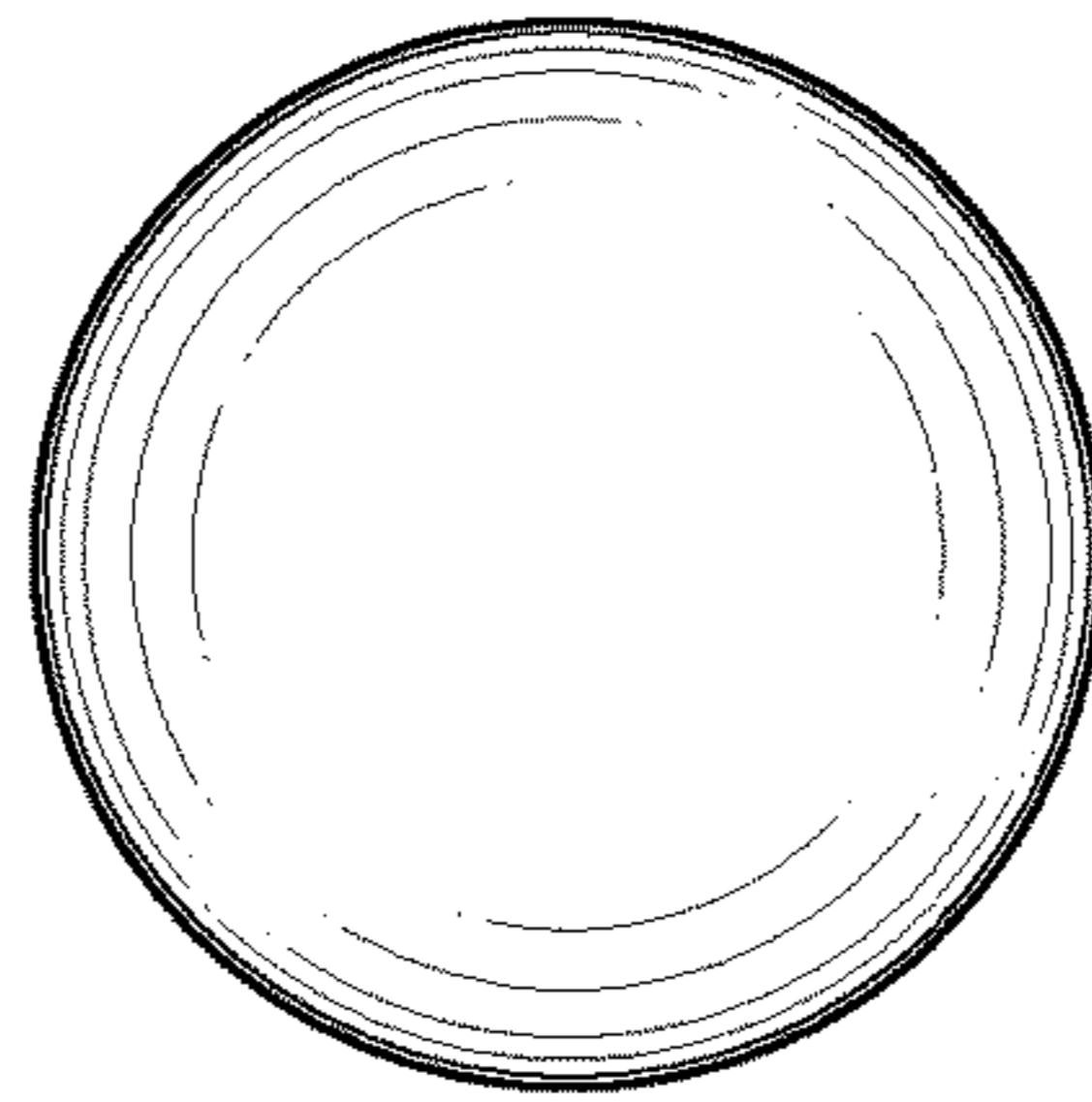
**FIG. 1**



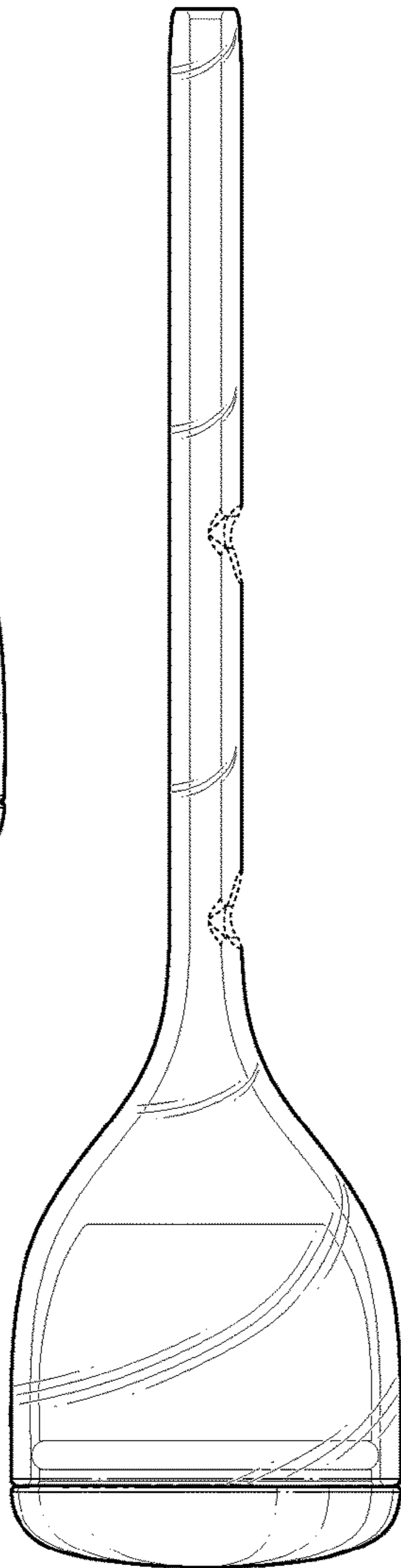
**FIG. 10**



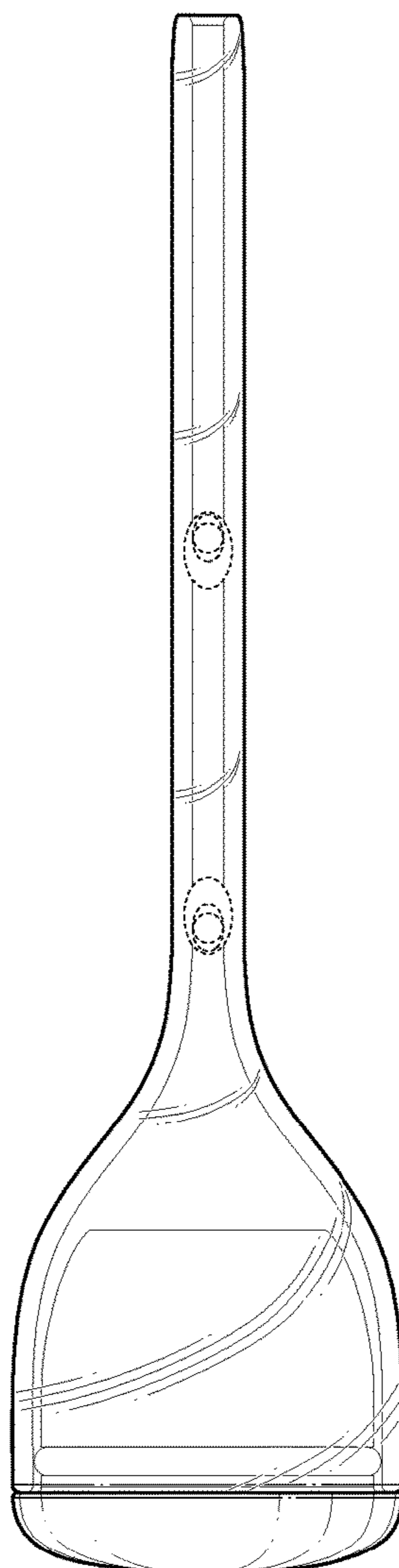
**FIG. 11**



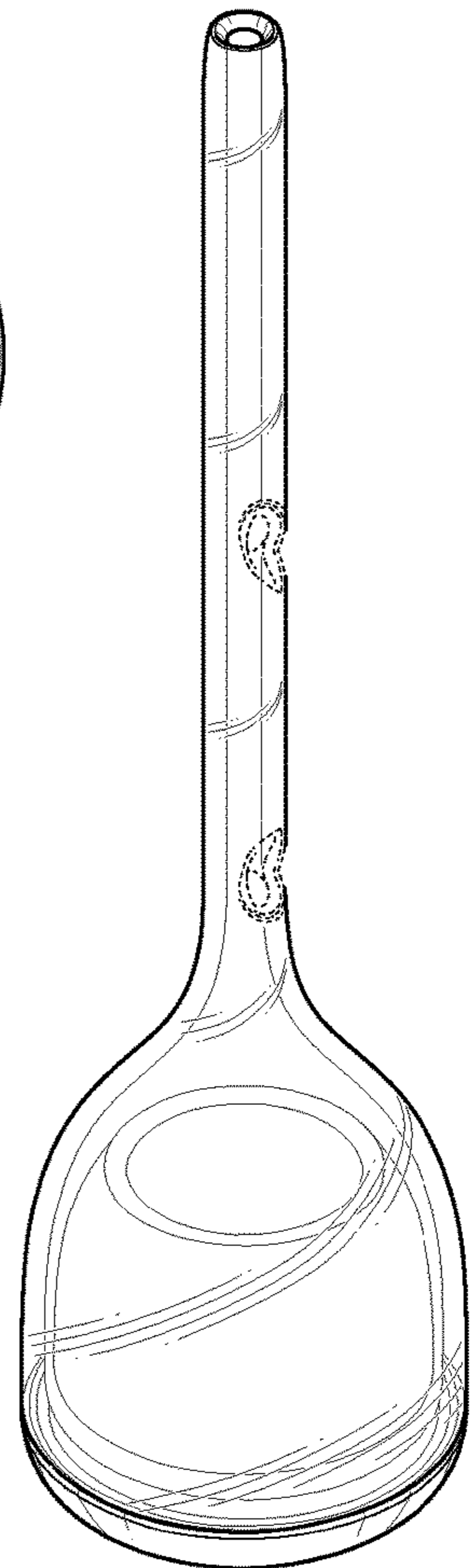
**FIG. 12**



**FIG. 9**



**FIG. 8**



**FIG. 7**