



US00D929000S

(12) **United States Design Patent** (10) **Patent No.:** **US D929,000 S**
Wu (45) **Date of Patent:** **** Aug. 24, 2021**

(54) **VEHICLE LIGHT**
(71) Applicant: **COPLUS INC.**, Tainan (TW)
(72) Inventor: **Po-Hua Wu**, Tainan (TW)
(73) Assignee: **COPLUS INC.**, Tainan (TW)
(**) Term: **15 Years**
(21) Appl. No.: **29/730,519**
(22) Filed: **Apr. 6, 2020**

(30) **Foreign Application Priority Data**
Feb. 6, 2020 (TW) 109300543

(51) **LOC (13) Cl.** **26-06**
(52) **U.S. Cl.**
USPC **D26/28**

(58) **Field of Classification Search**
USPC D26/28-36, 139
CPC F21S 48/00; F21S 48/10; F21S 48/115;
F21S 48/225; F21S 48/1233; F21S
48/1266; F21S 48/1388; F21S 48/2268;
B60Q 9/13; B60Q 9/135; B60Q 9/1375;
F21V 21/04; F21V 29/004
See application file for complete search history.

(56) **References Cited**
U.S. PATENT DOCUMENTS
D474,290 S * 5/2003 Sawai D26/28
D549,858 S * 8/2007 Pfeiffer D26/28
D552,772 S * 10/2007 Davidson D26/28

D586,010 S * 2/2009 Saracoglu D26/28
D592,332 S * 5/2009 Hsu D26/28
D592,336 S * 5/2009 Hsu D26/28

* cited by examiner

Primary Examiner — Marcus A Jackson

(74) *Attorney, Agent, or Firm* — Lewis Roca Rothgerber
Christie LLP

(57) **CLAIM**

The ornamental design for vehicle light, as shown and described.

DESCRIPTION

FIG. 1 is a perspective view of a vehicle light;
FIG. 2 is a front view thereof;
FIG. 3 is a back view thereof;
FIG. 4 is a left side view thereof;
FIG. 5 is a right side view thereof;
FIG. 6 is a top view thereof; and,
FIG. 7 is a bottom view thereof.

The broken lines in the drawings are for illustrative purpose only and form no part of the claimed design.

1 Claim, 7 Drawing Sheets

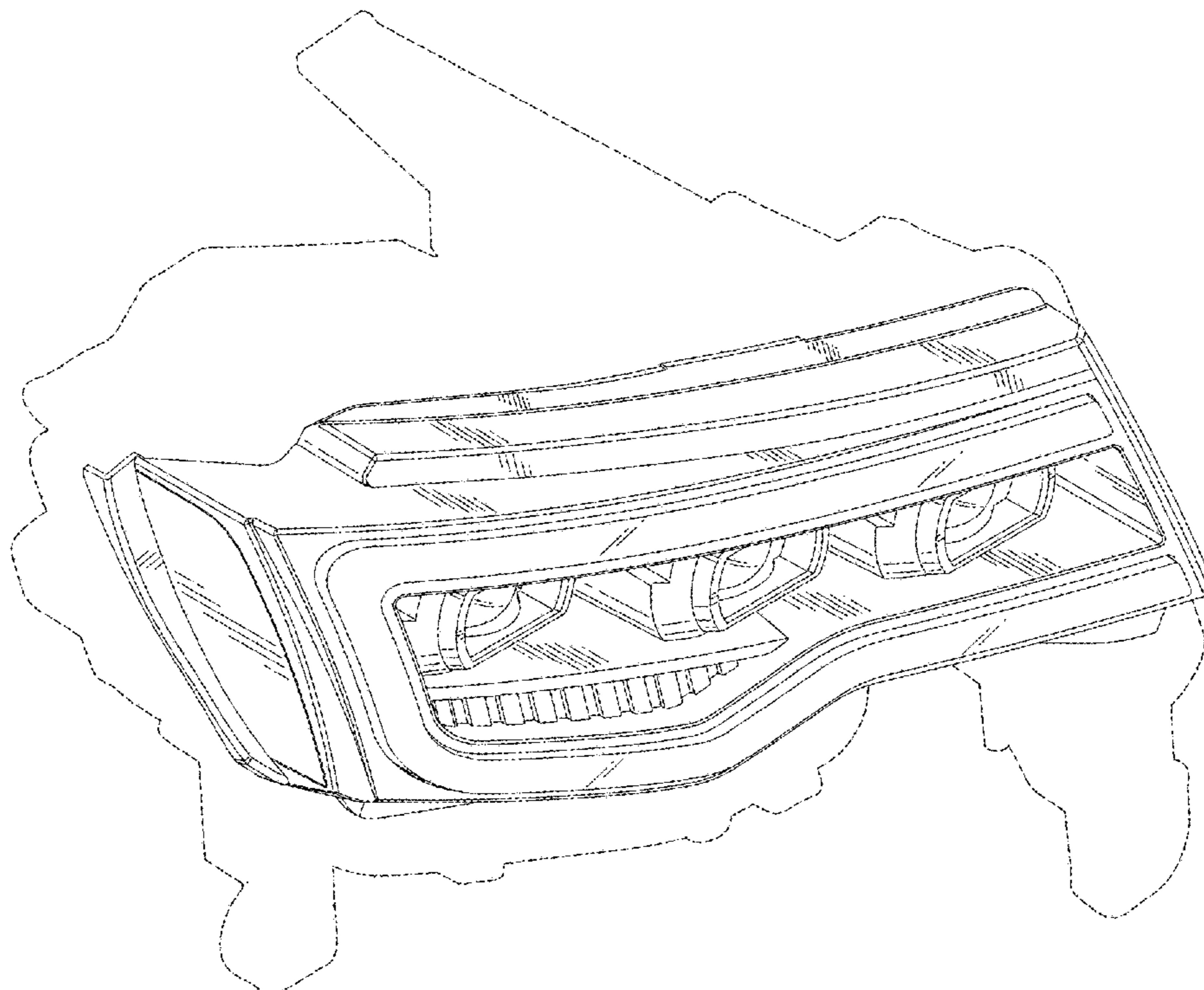
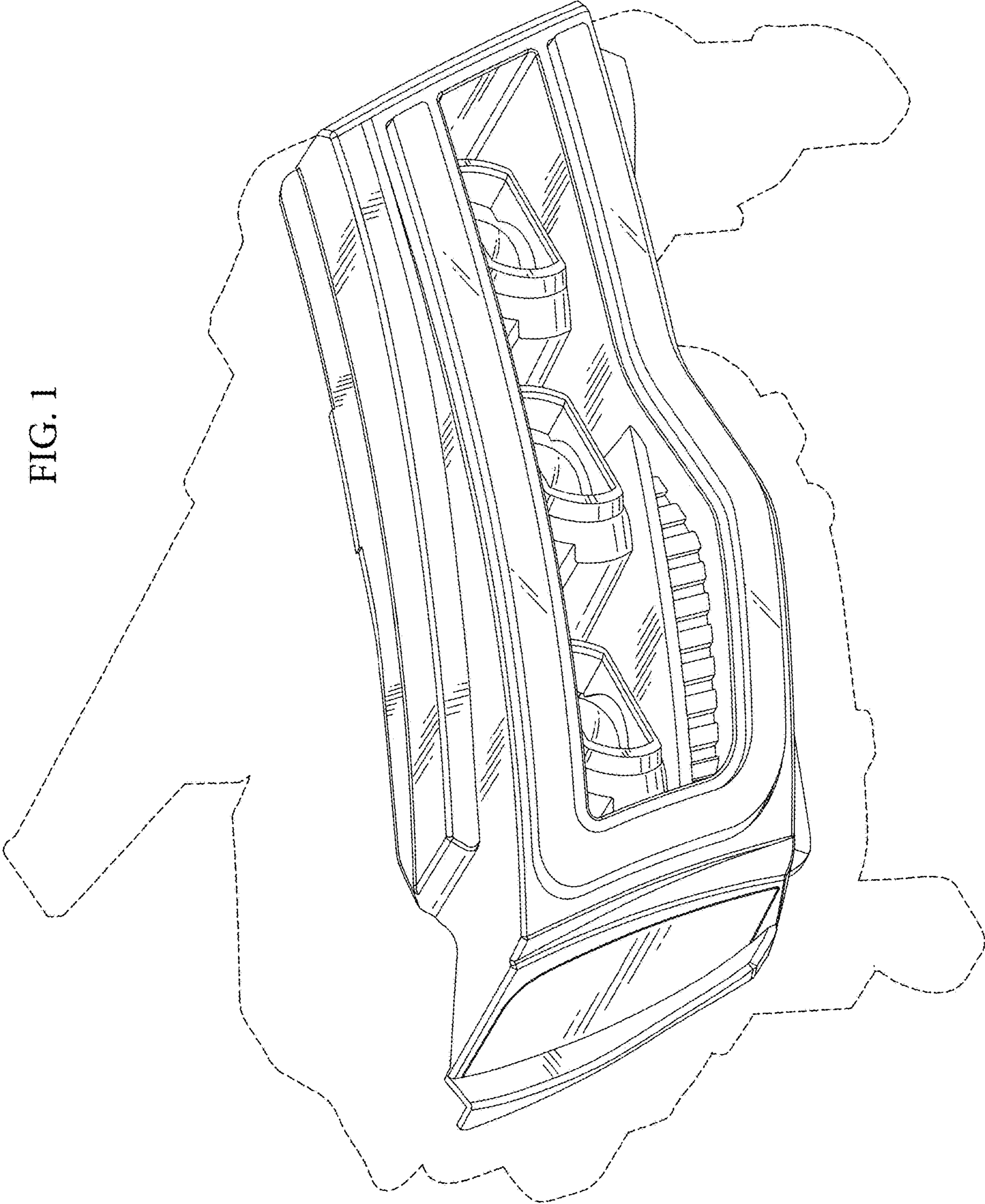

FIG. 1



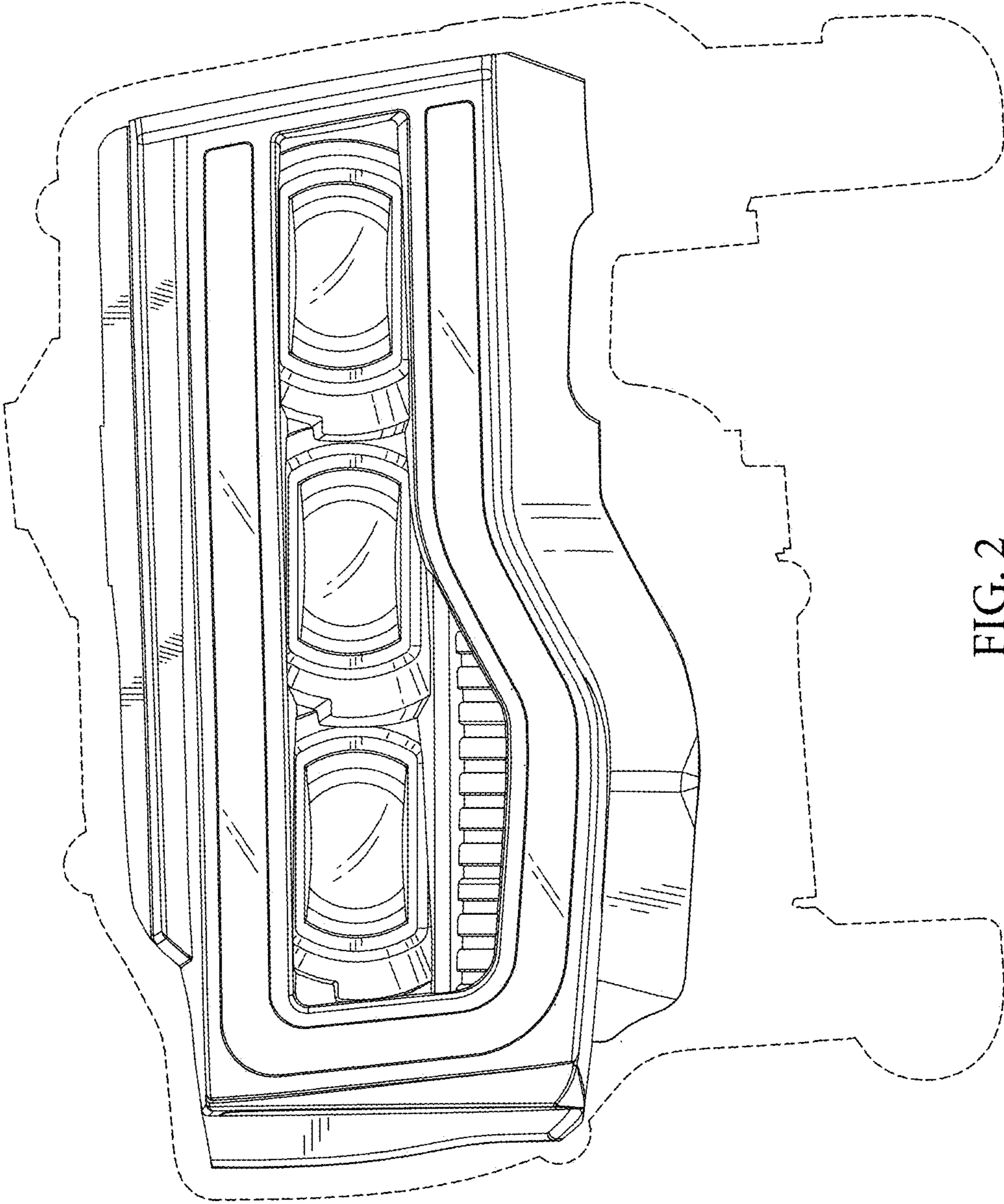

FIG. 2

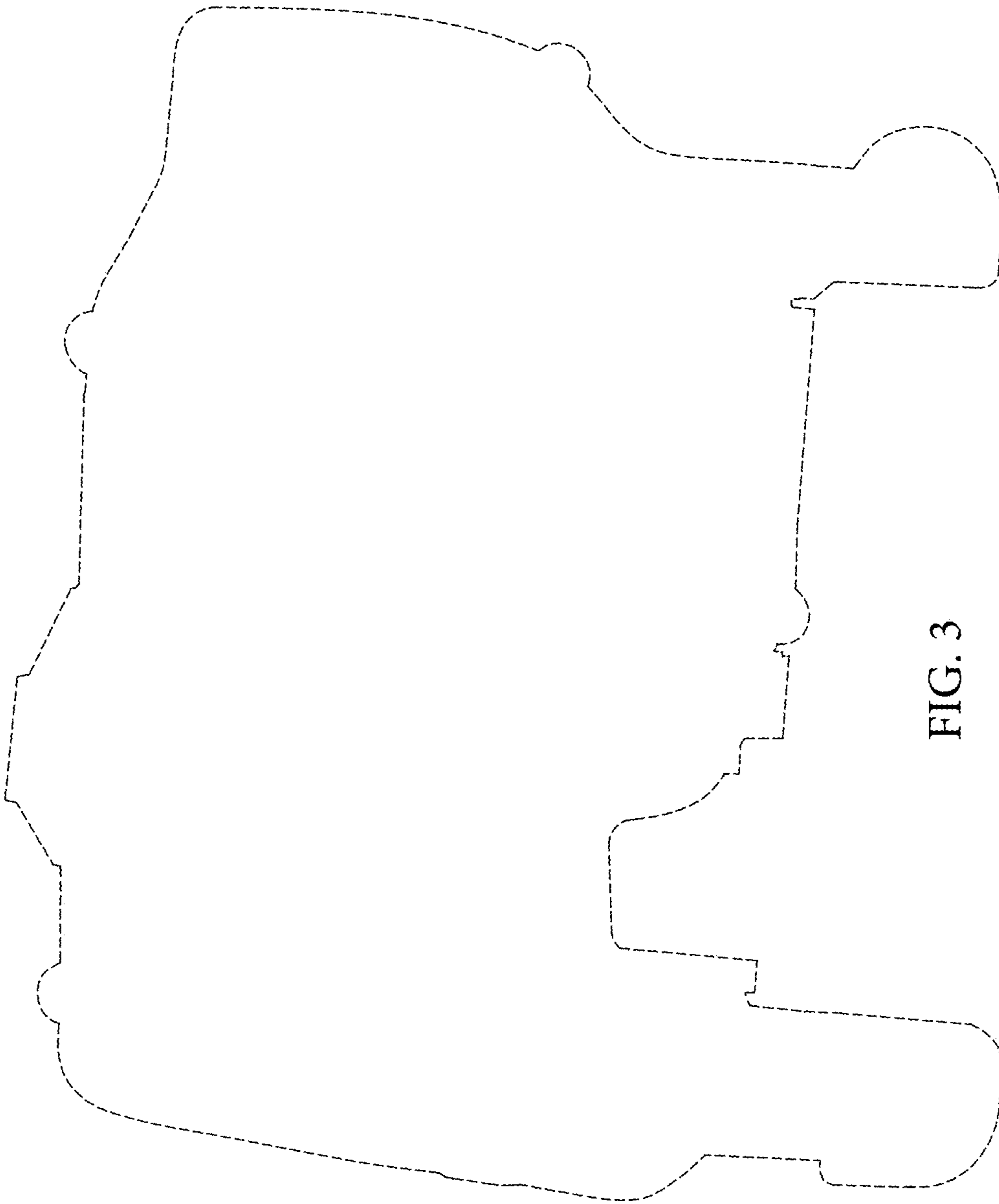

FIG. 3

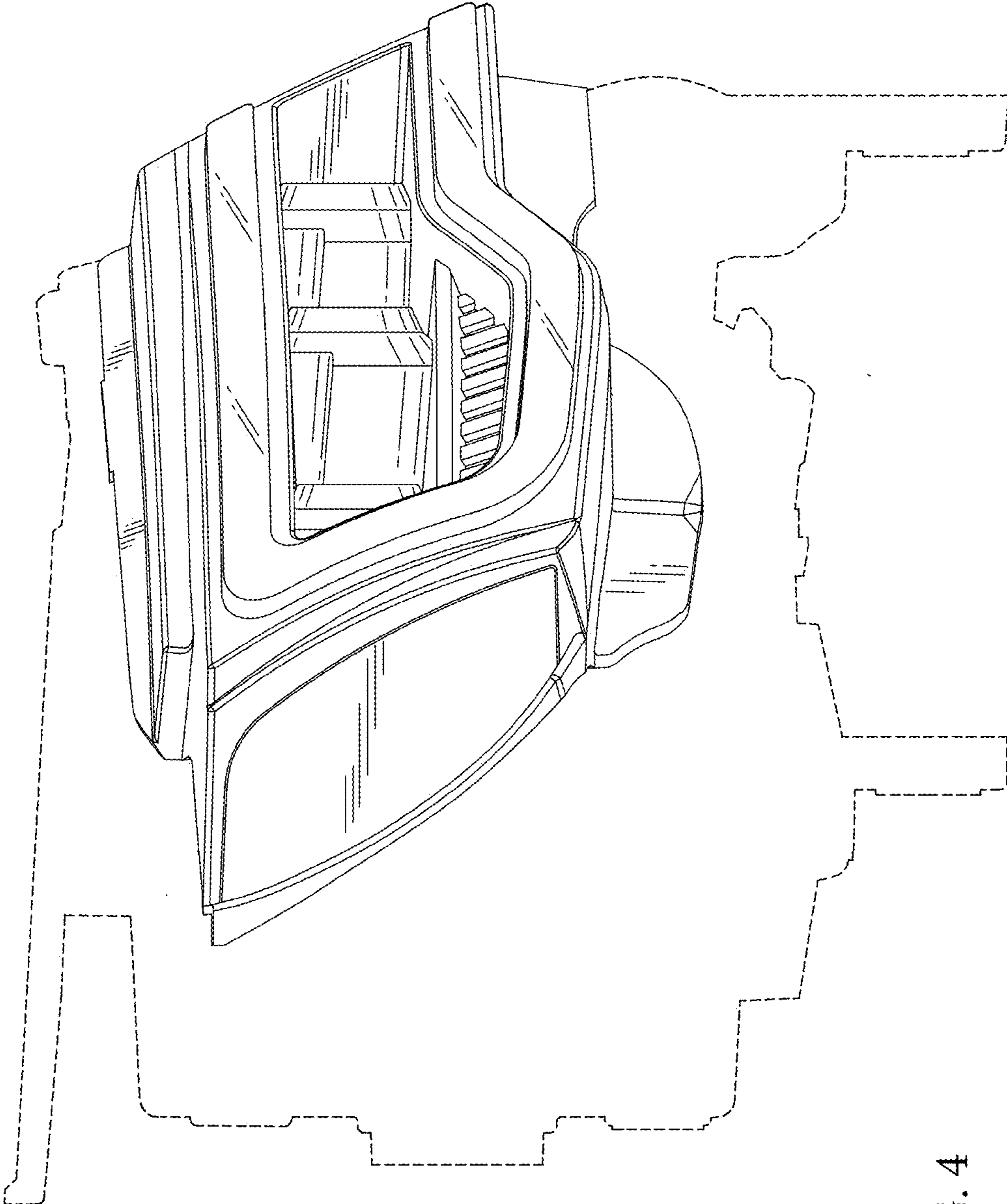

FIG. 4

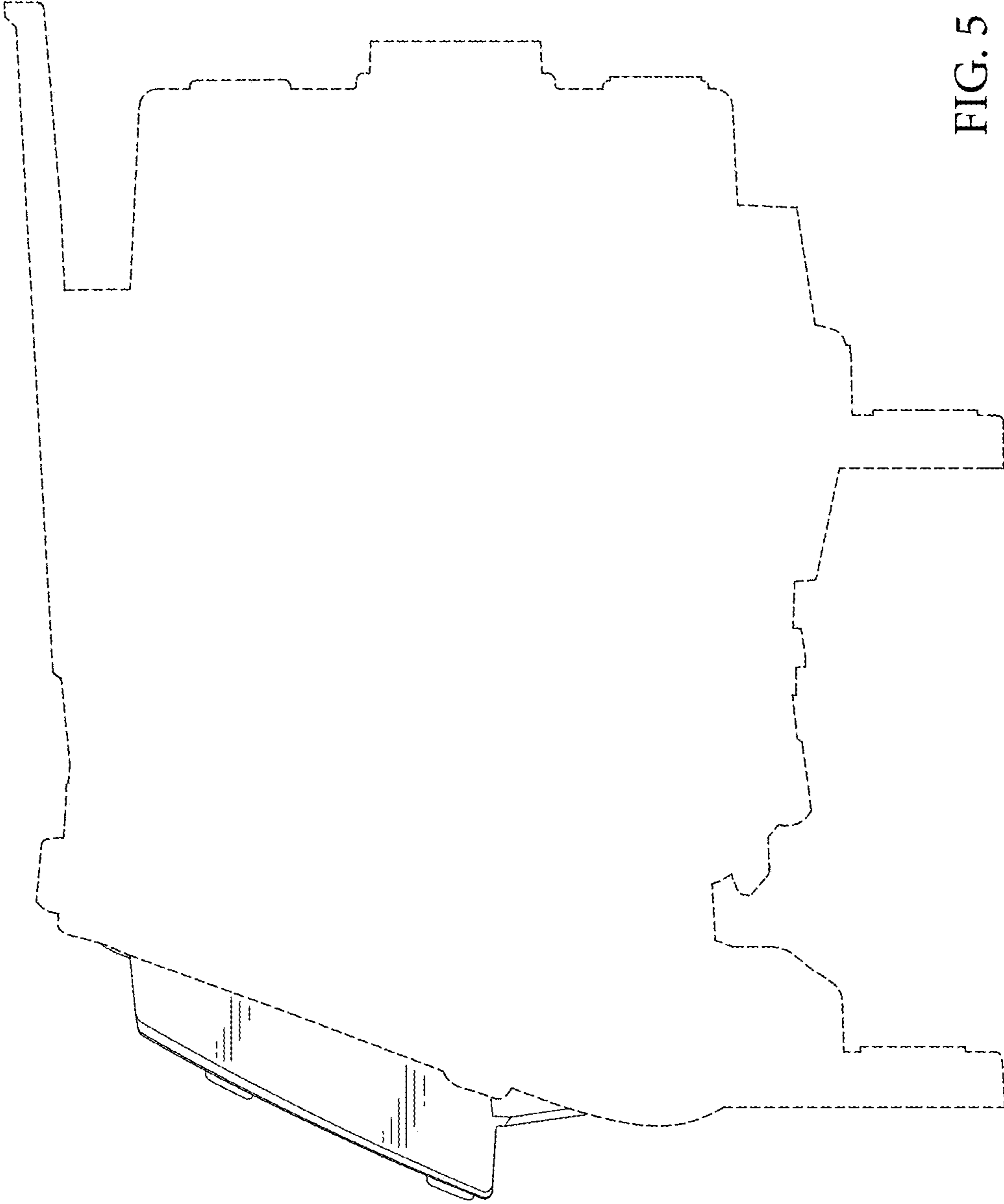

FIG. 5

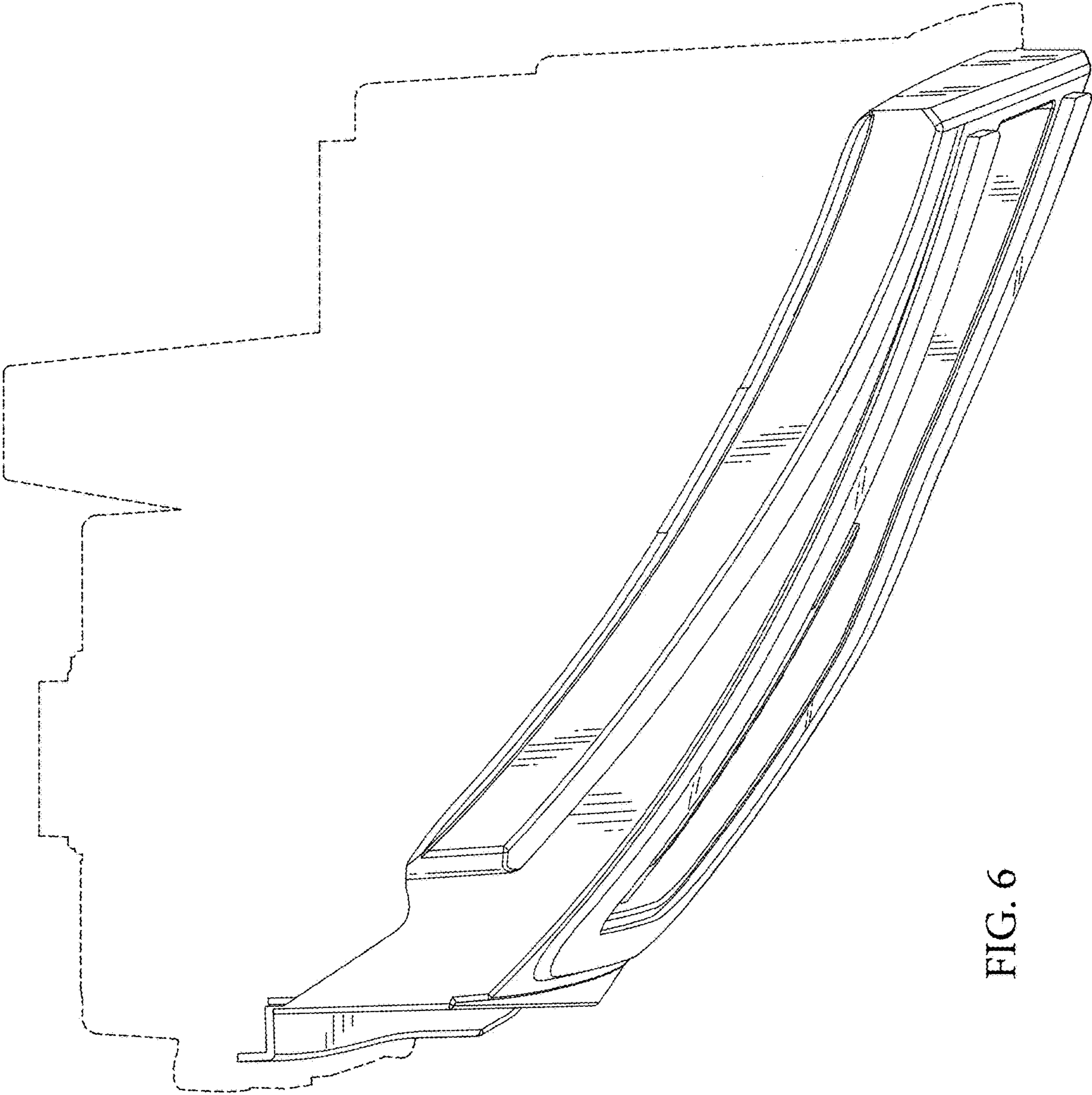

FIG. 6

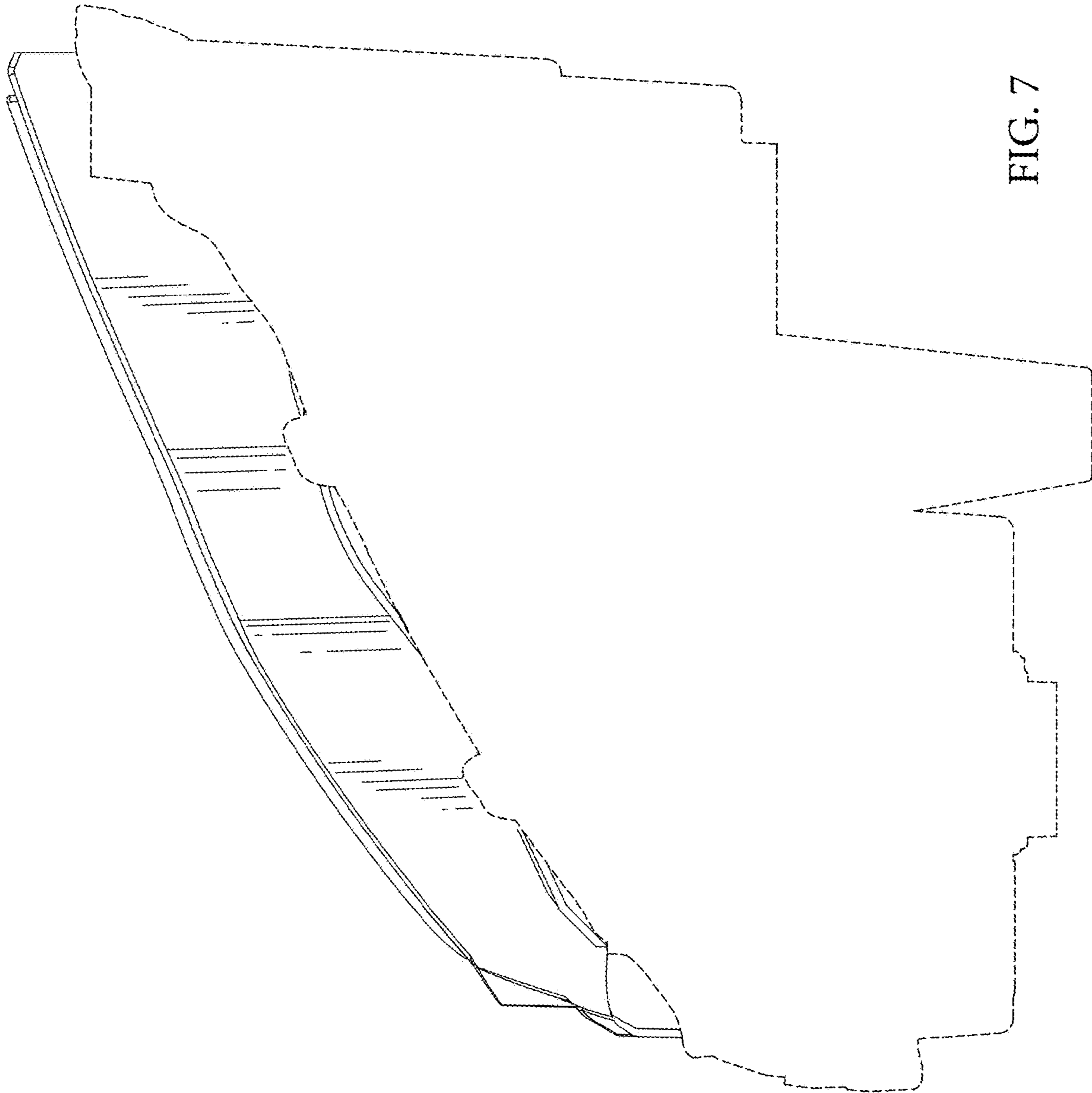

FIG. 7