



US00D928966S

(12) **United States Design Patent**  
**Lehtonen**

(10) **Patent No.:** **US D928,966 S**

(45) **Date of Patent:** **\*\* Aug. 24, 2021**

(54) **ORAL APPLIANCE**

(71) Applicant: **LM-Instruments Oy**, Parainen (FI)

(72) Inventor: **Kari Lehtonen**, Parainen (FI)

(73) Assignee: **Planmeca OY**, Helsinki (FI)

(\*\*) Term: **15 Years**

(21) Appl. No.: **29/690,329**

(22) Filed: **May 7, 2019**

**Related U.S. Application Data**

(62) Division of application No. 29/603,476, filed on May 10, 2017, now Pat. No. Des. 851,771, which is a division of application No. 35/500,185, filed on Sep. 25, 2015 (U.S. filing date under 35 U.S.C. 384), and having an international filing date of Sep. 25, 2015, now Pat. No. Des. 790,068.

(51) **LOC (13) Cl.** ..... **24-02**

(52) **U.S. Cl.**  
USPC ..... **D24/181**

(58) **Field of Classification Search**  
USPC ..... D24/180-182; D29/108  
CPC ..... A61F 5/56; A61F 5/566; A61F 2005/563;  
A61C 7/08; A61C 9/0006; A63B 71/085;  
A63B 2071/086

See application file for complete search history.

(56) **References Cited**

**U.S. PATENT DOCUMENTS**

3,312,218 A \* 4/1967 Jacobs ..... A63B 71/085  
128/862  
D492,785 S \* 7/2004 Garabito ..... D24/181

D597,675 S \* 8/2009 Eli ..... D24/181  
D621,942 S \* 8/2010 Massad ..... D24/181  
D717,447 S \* 11/2014 Farrell ..... D24/181  
D799,049 S \* 10/2017 Farrell ..... D24/181  
10,898,369 B2 \* 1/2021 Farrell ..... A61F 5/566  
2010/0288290 A1 \* 11/2010 Lee ..... A61F 5/566  
128/861

\* cited by examiner

*Primary Examiner* — Wan Laymon

(74) *Attorney, Agent, or Firm* — Fay Sharpe LLP

(57) **CLAIM**

I claim the ornamental design for an oral appliance, as shown and described.

**DESCRIPTION**

FIG. 1 is a rear view of an oral appliance;  
FIG. 2 is a right side view thereof;  
FIG. 3 is a left side view thereof;  
FIG. 4 is a front view thereof;  
FIG. 5 is a top view thereof;  
FIG. 6 is a bottom view thereof;  
FIG. 7 is a perspective view of the oral appliance.  
FIG. 8 is a rear view of an alternative oral appliance;  
FIG. 9 is a right side view of the alternative oral appliance;  
FIG. 10 is a left side view of the alternative oral appliance;  
FIG. 11 is a front view of the alternative oral appliance;  
FIG. 12 is a top view of the alternative oral appliance;  
FIG. 13 is a bottom view of the alternative oral appliance;  
and,  
FIG. 14 is a perspective view of the alternative oral appliance.

**1 Claim, 14 Drawing Sheets**

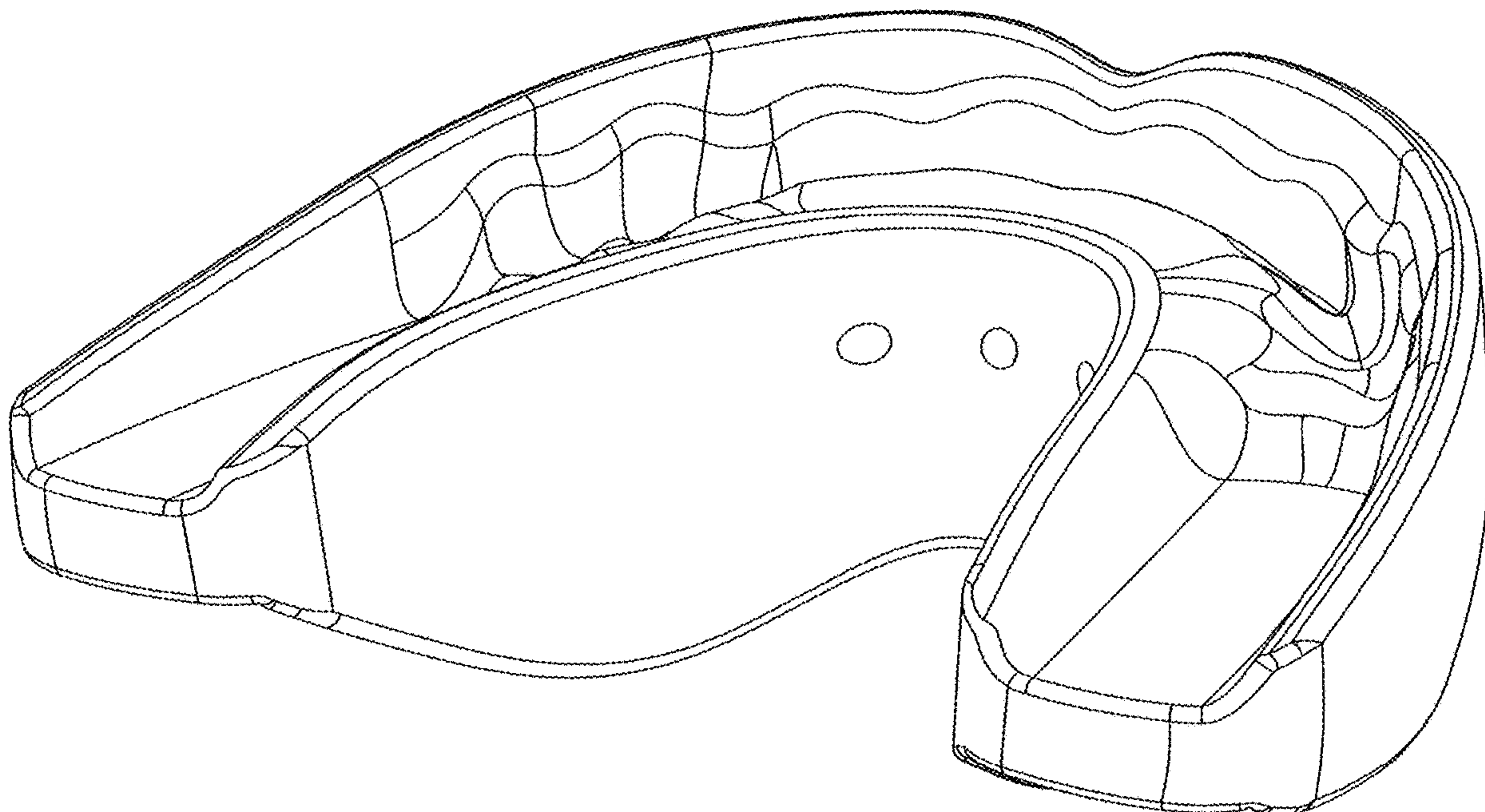

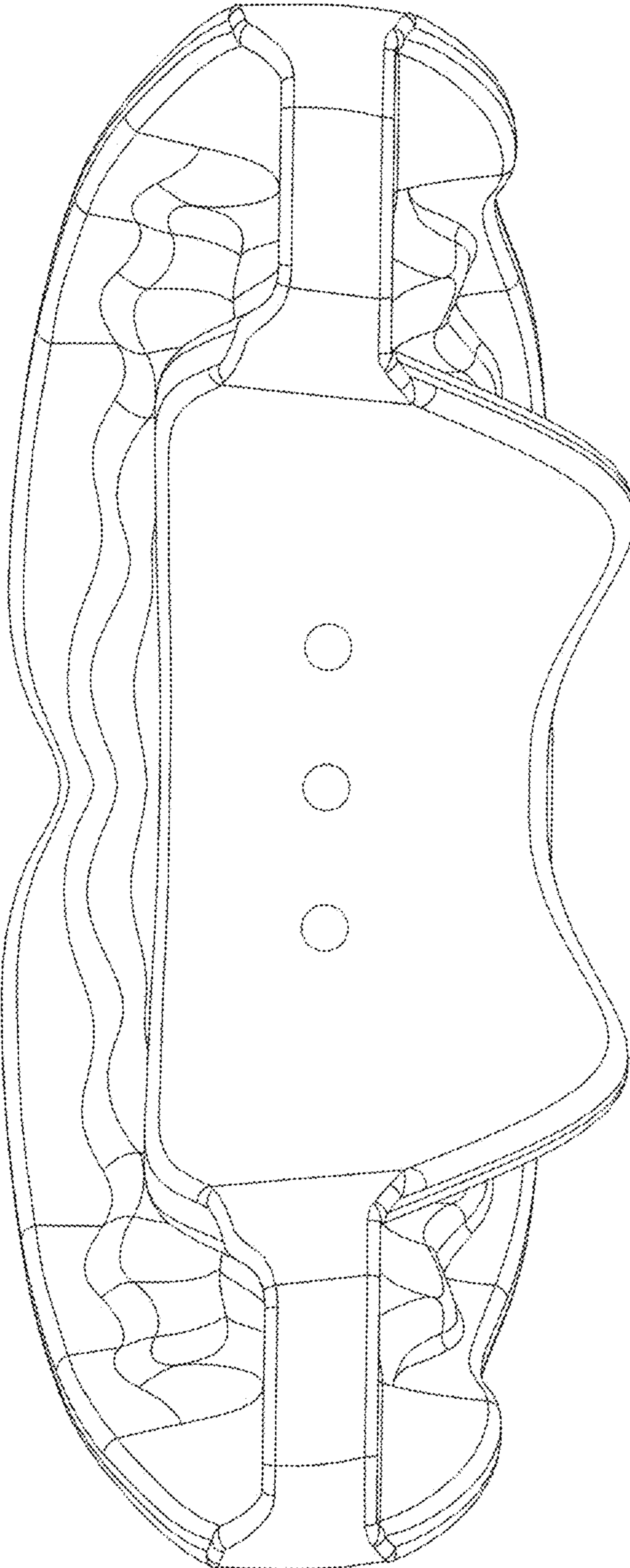

FIG. 1

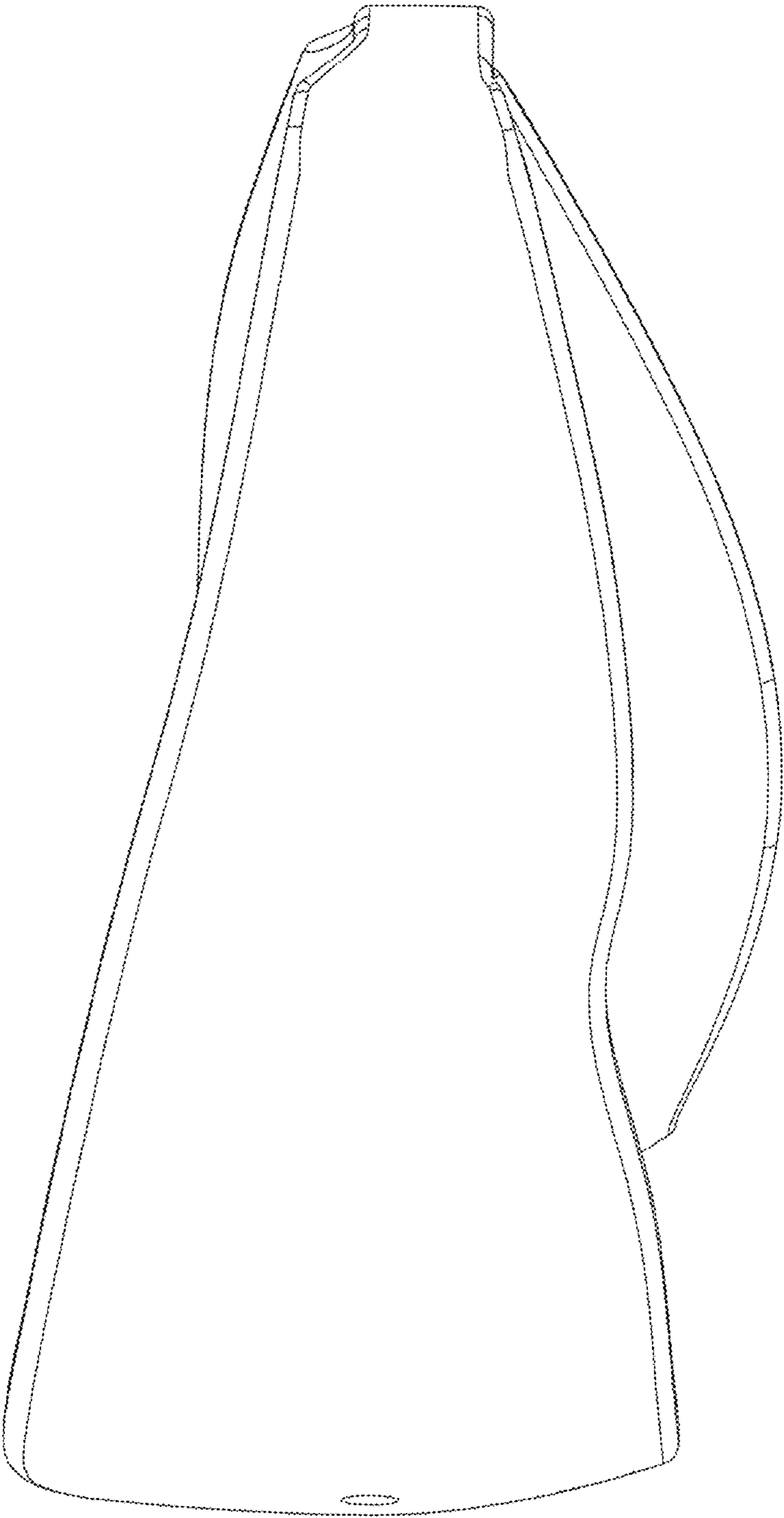

FIG. 2

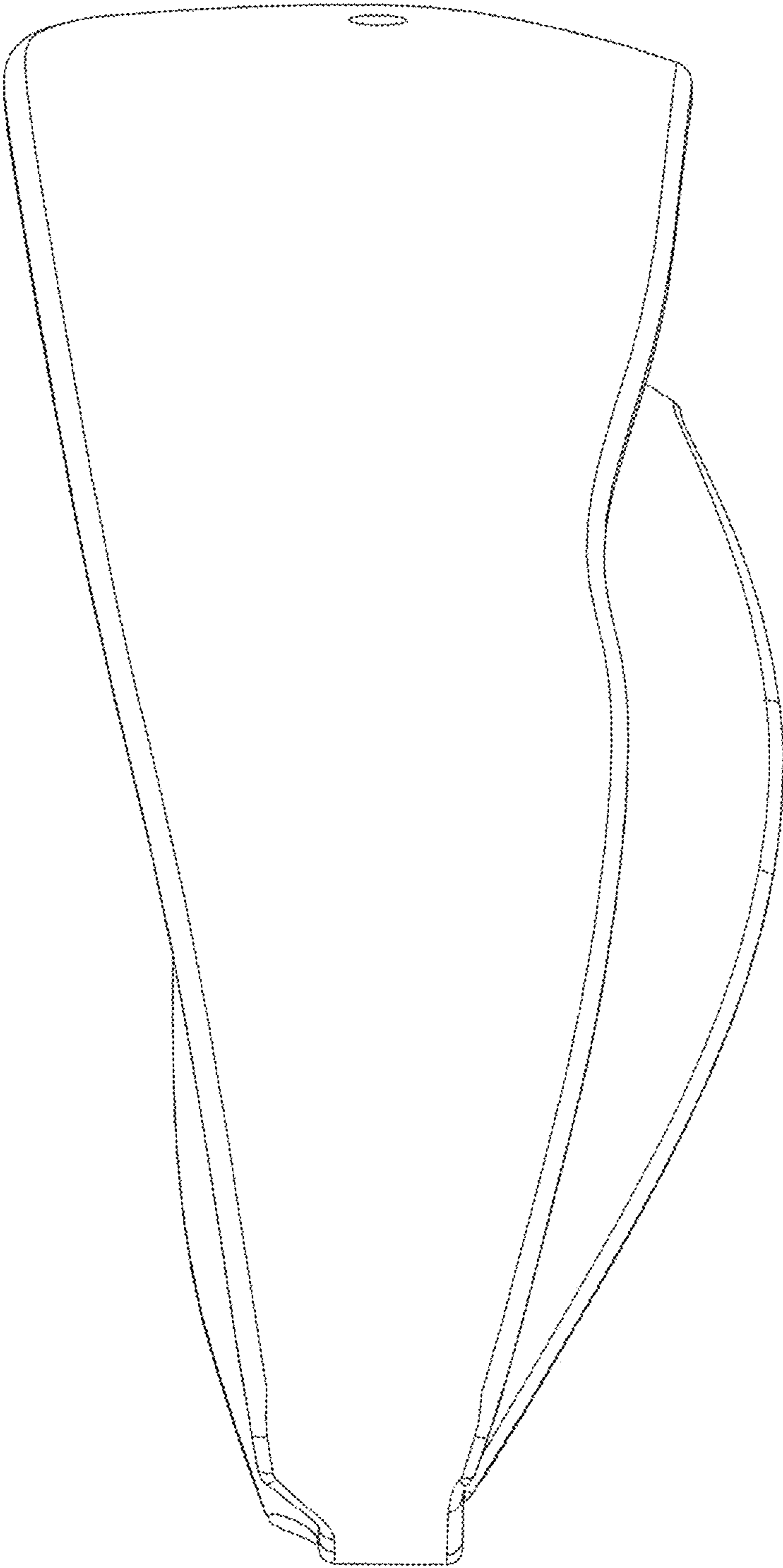

FIG. 3

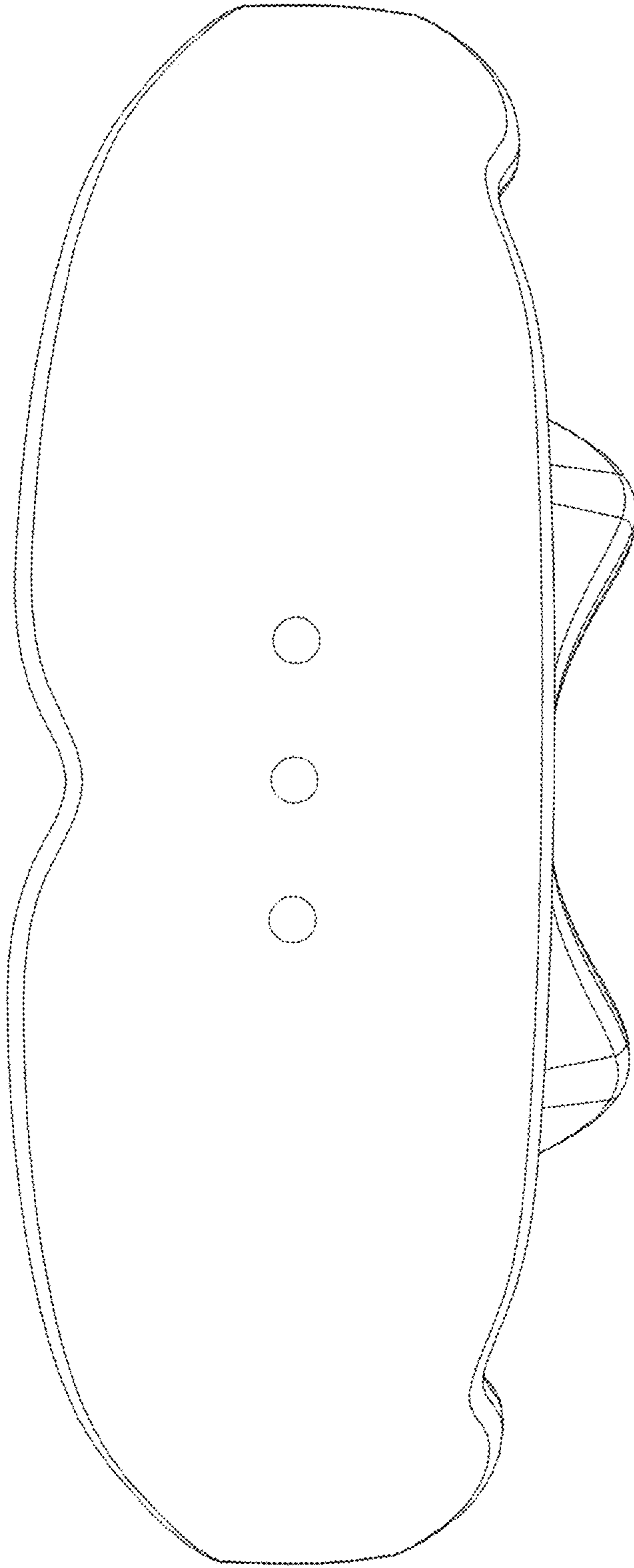

FIG. 4

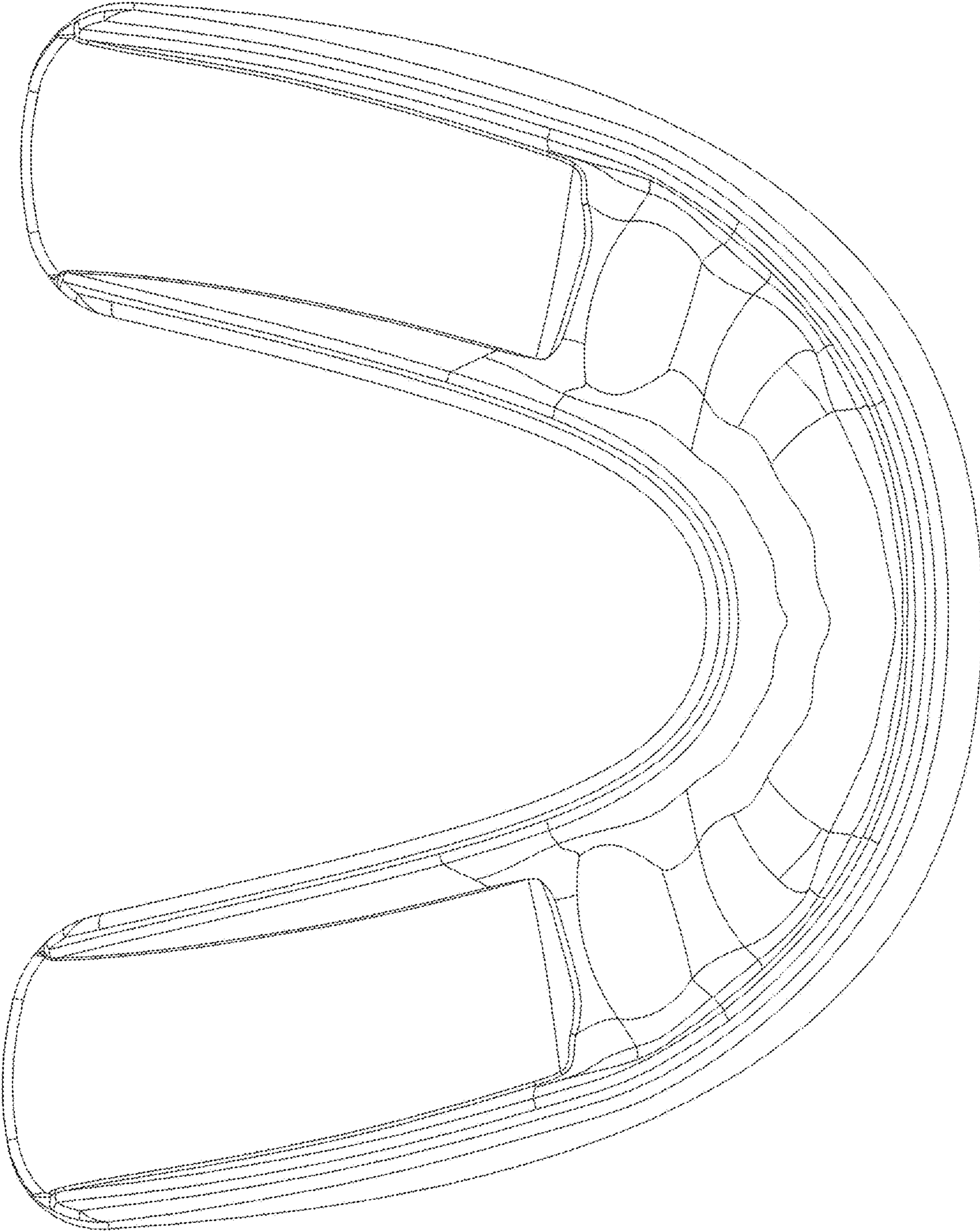

FIG. 5

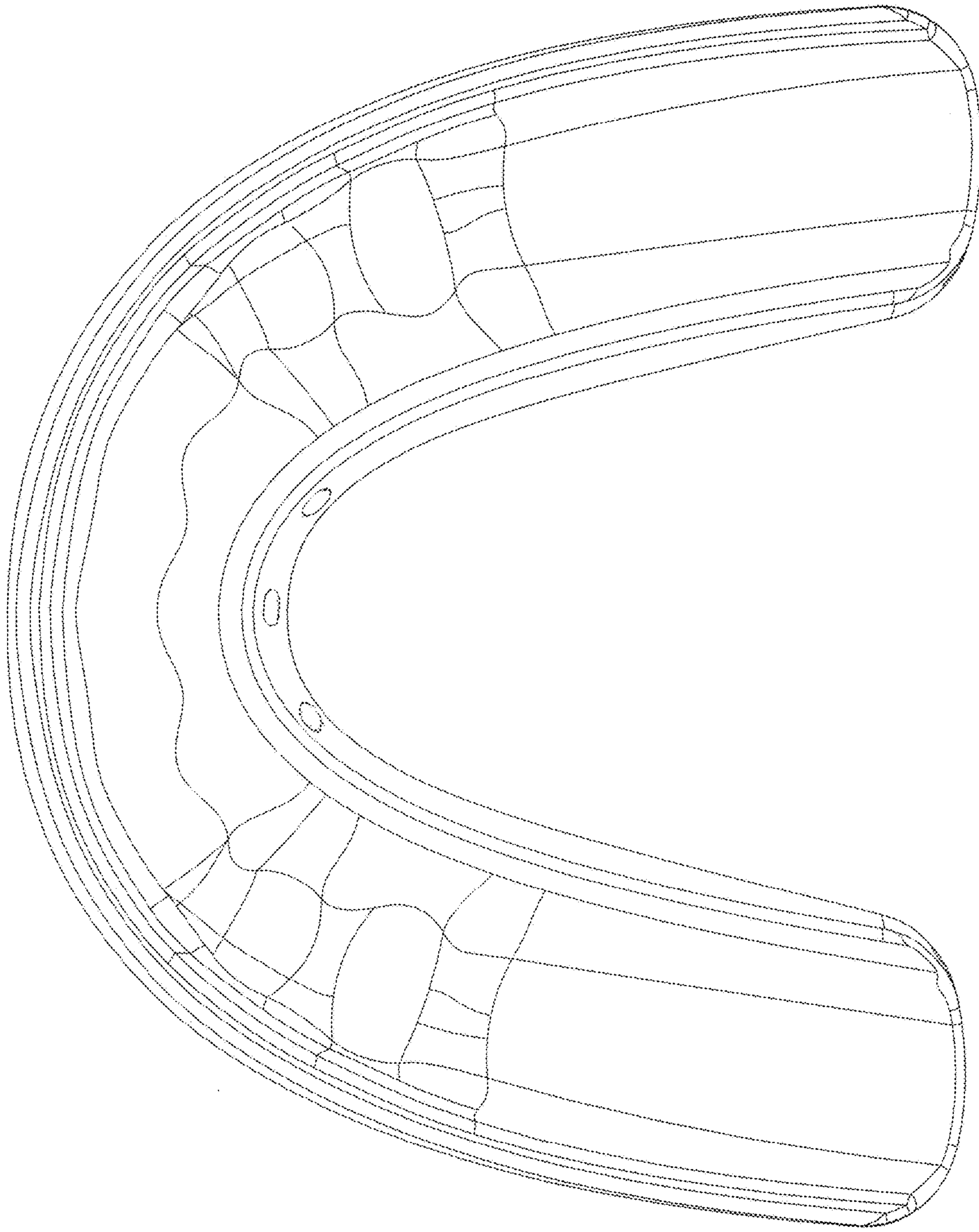

FIG. 6

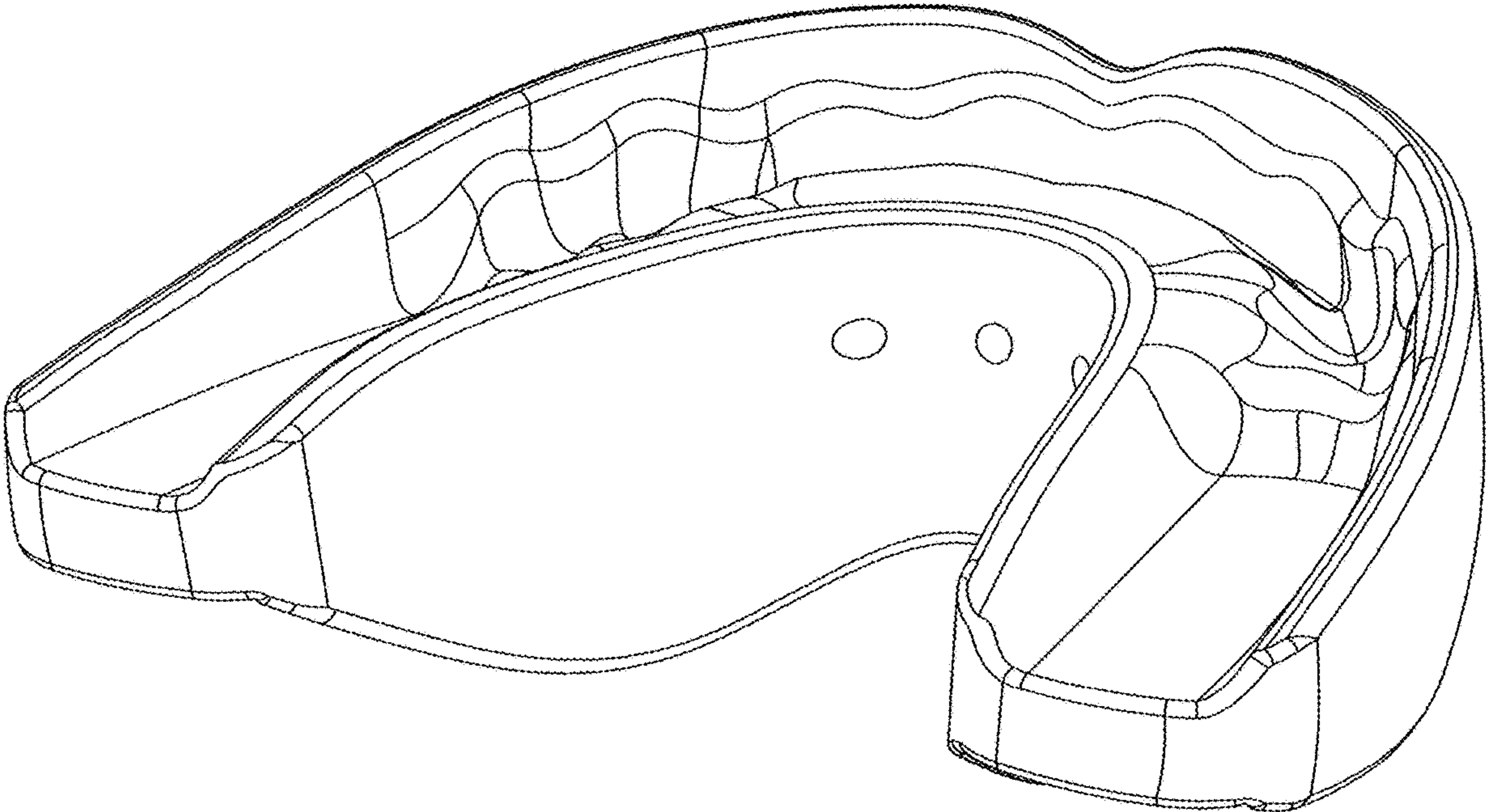

FIG. 7



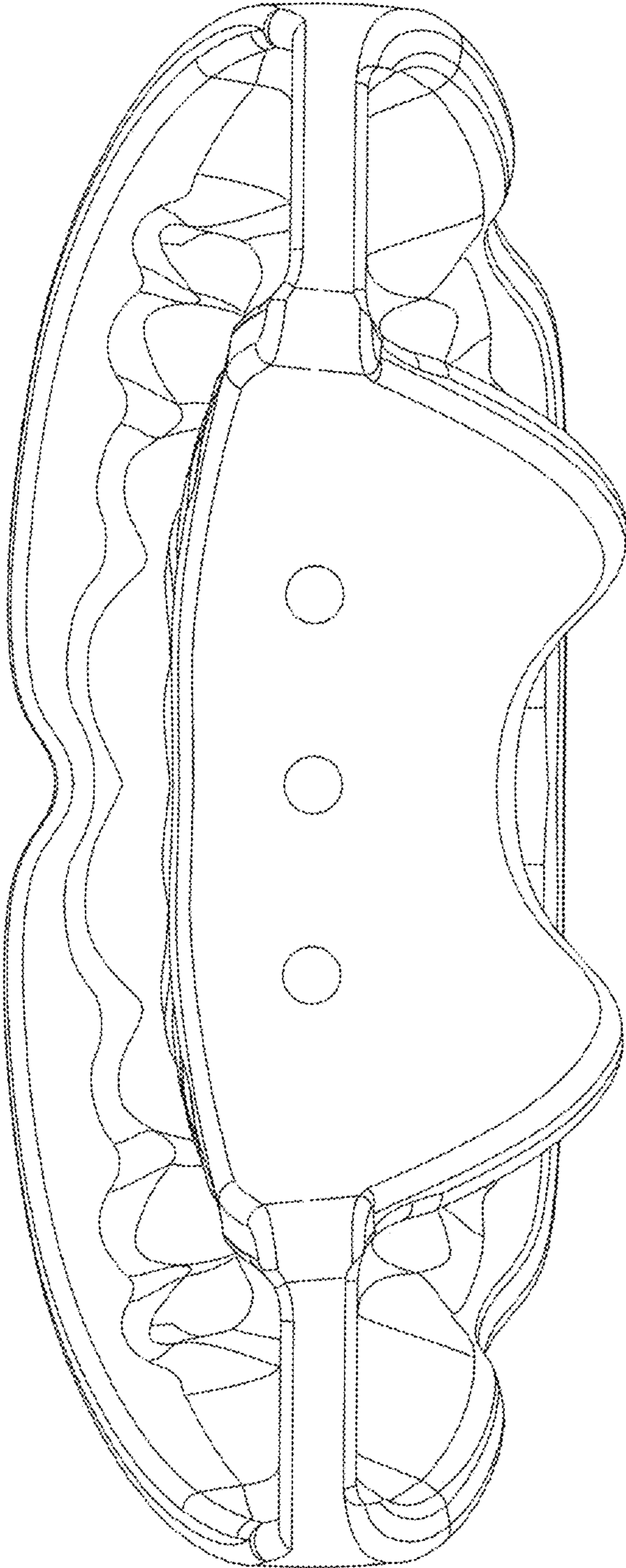

FIG. 8

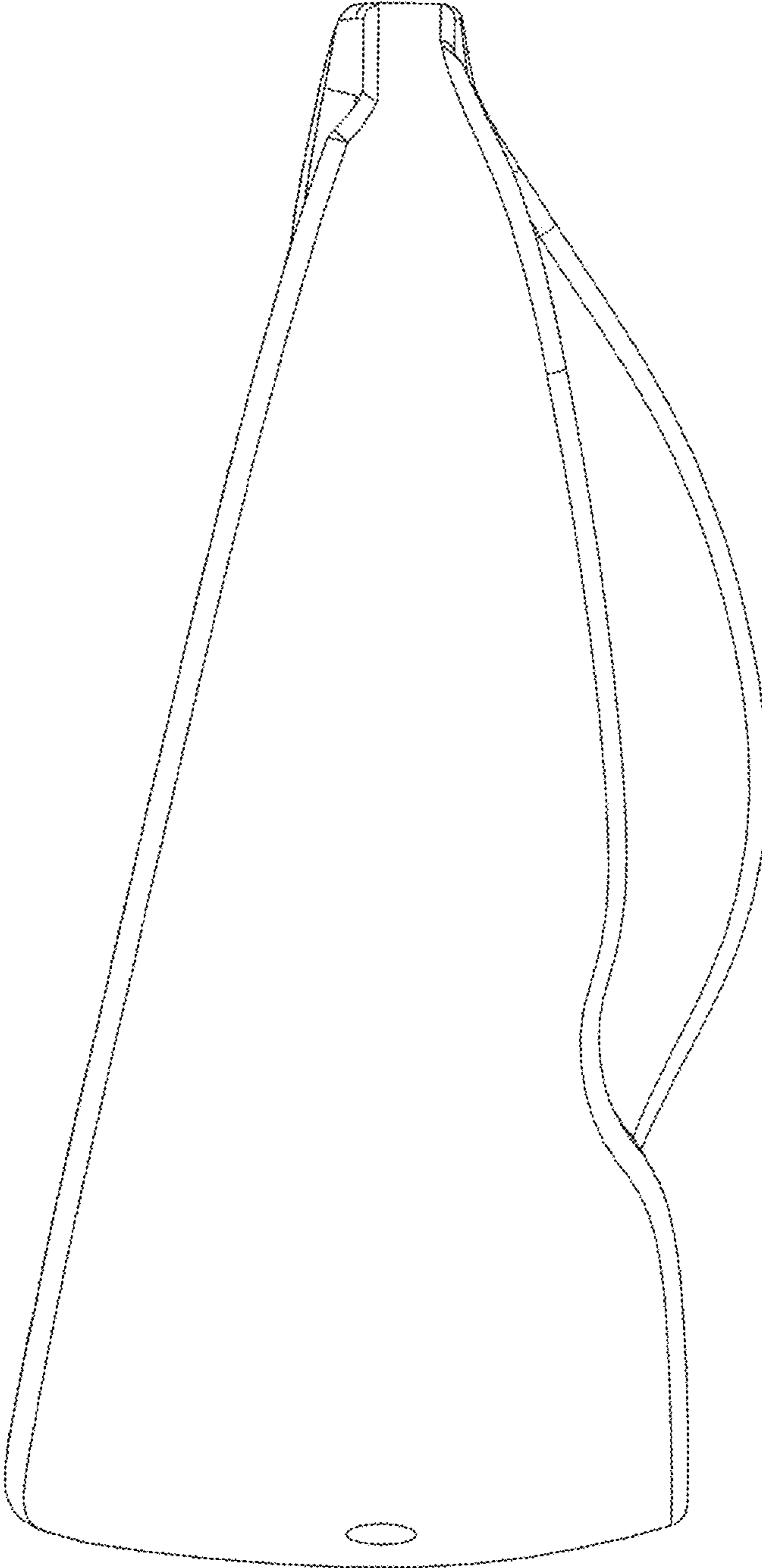

FIG. 9

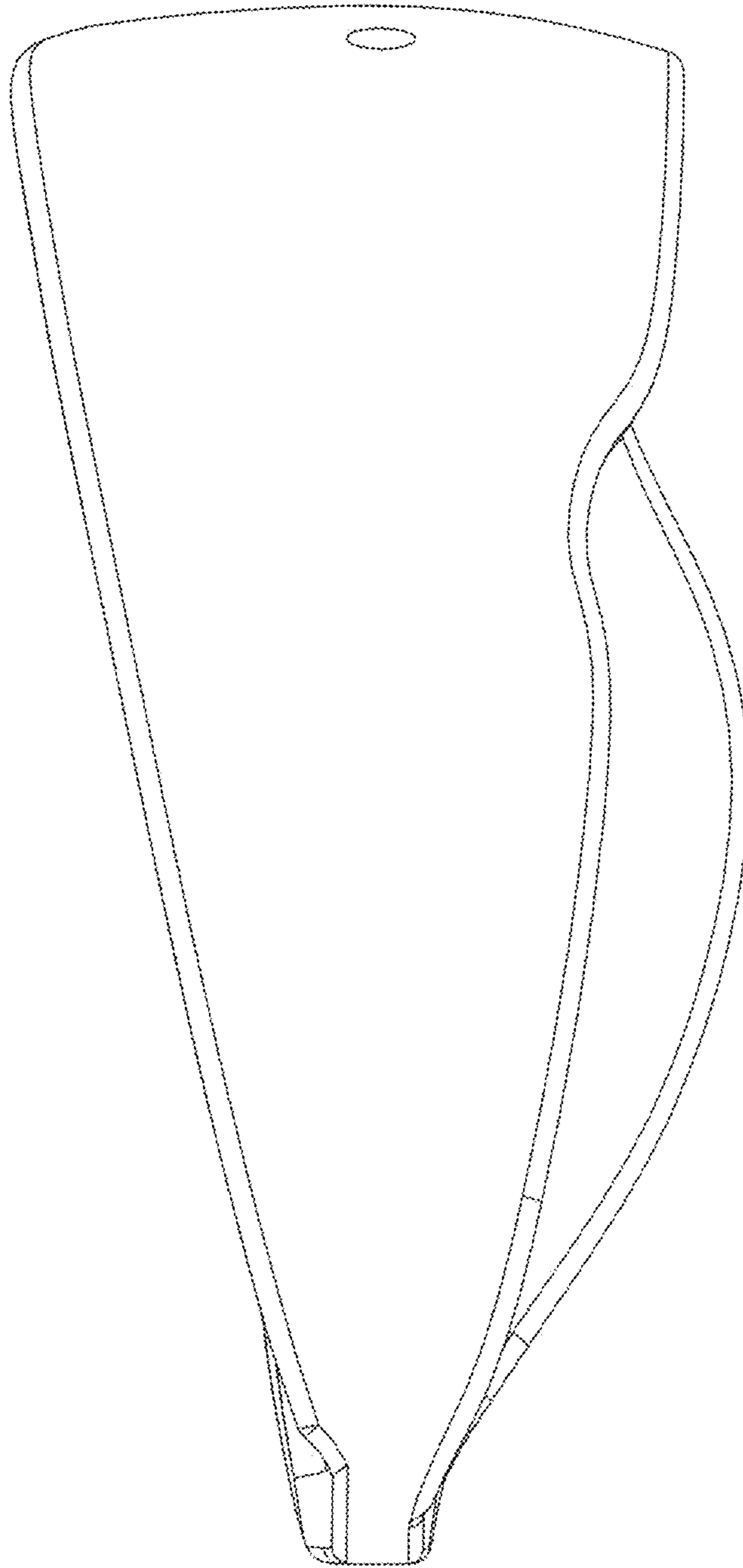

FIG. 10

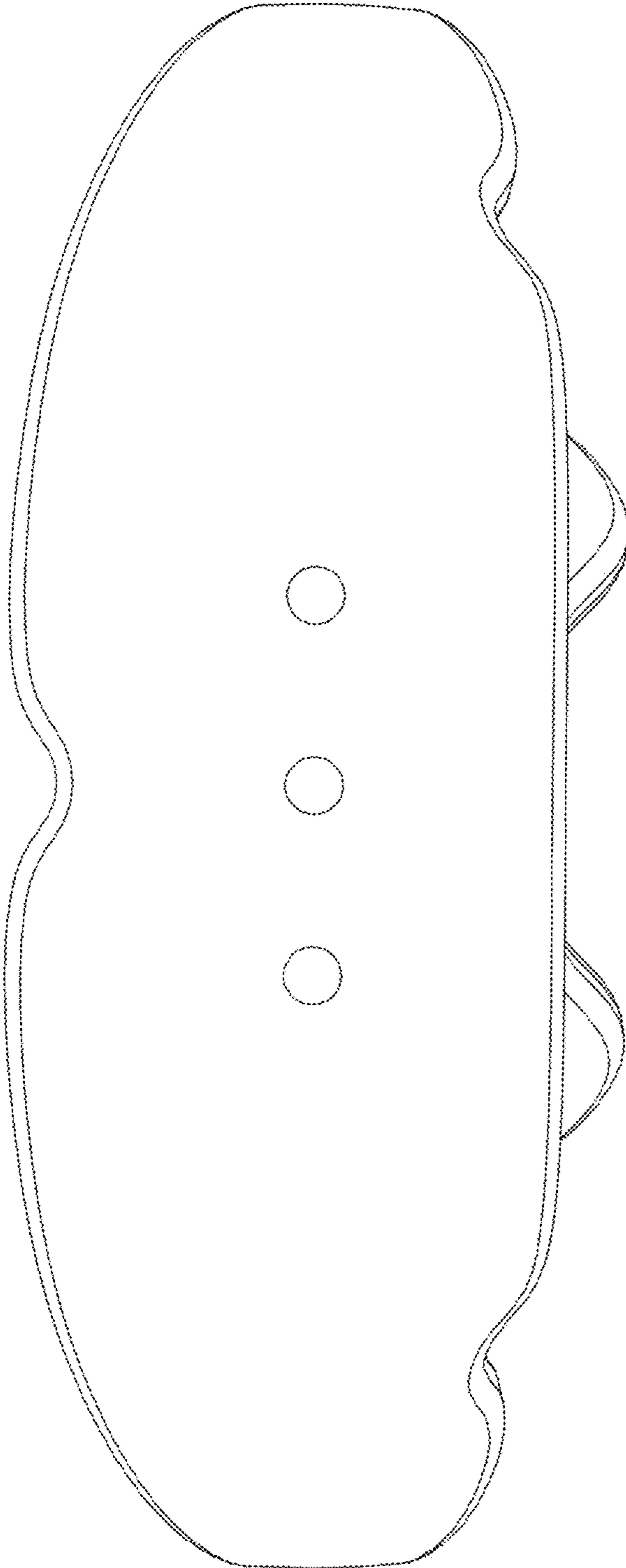

FIG. 11

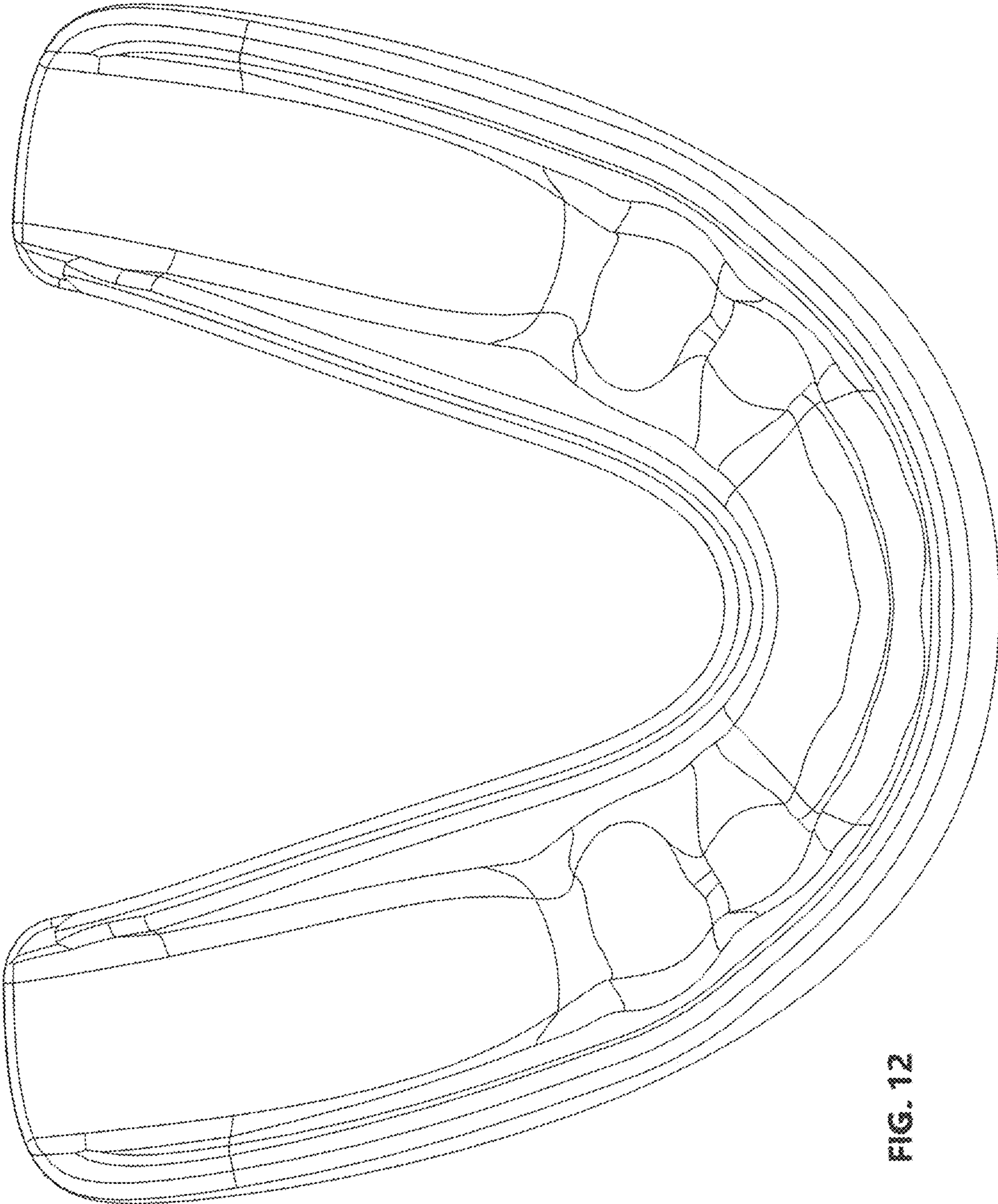

FIG. 12

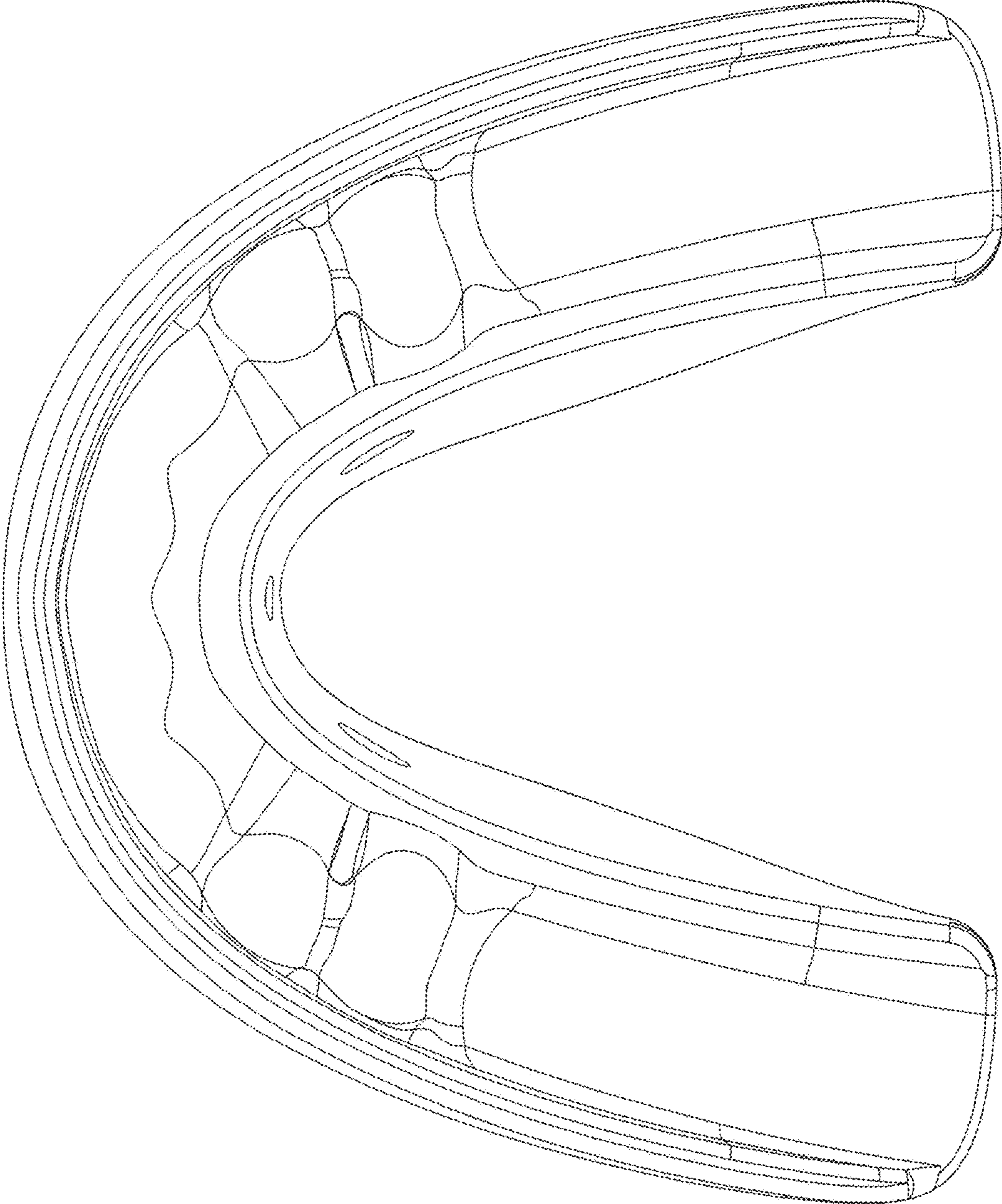

FIG. 13

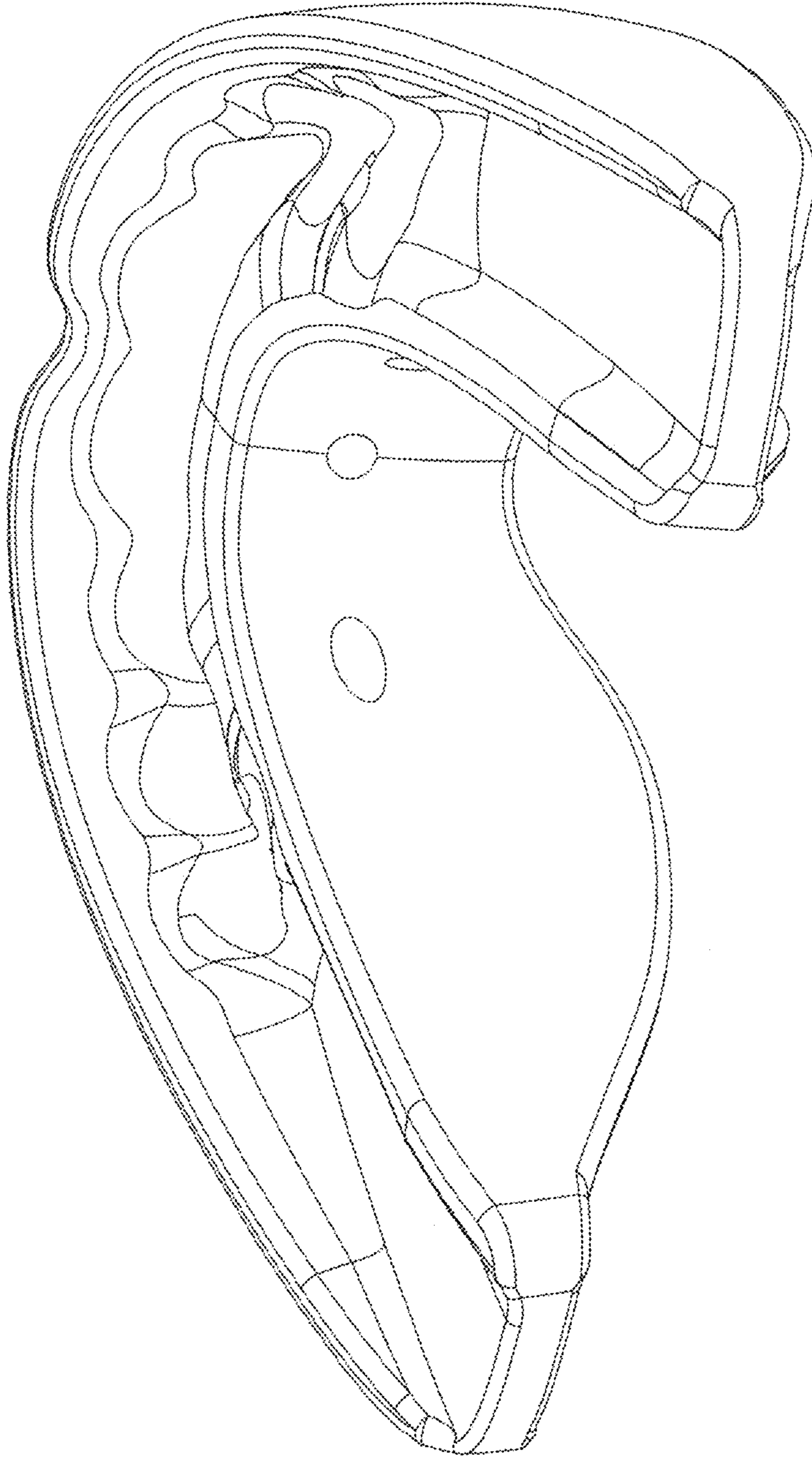

FIG. 14