



US00D928955S

(12) **United States Design Patent**
Michaels

(10) **Patent No.:** **US D928,955 S**

(45) **Date of Patent:** **** Aug. 24, 2021**

(54) **BLADE HOLDER**

(71) Applicant: **David Lawrence Michaels**, North York (CA)

(72) Inventor: **David Lawrence Michaels**, North York (CA)

(**) Term: **15 Years**

(21) Appl. No.: **29/725,648**

(22) Filed: **Feb. 26, 2020**

(51) **LOC (13) Cl.** **24-02**

(52) **U.S. Cl.**
USPC **D24/146**

(58) **Field of Classification Search**
USPC D24/133, 146, 152; D8/14, 98, 99, 107; D32/46, 48, 49
CPC A61B 17/42; A61B 17/3211; A61B 2090/0801; A61B 2090/08021; A61B 2017/00429; A61B 2017/00424; B26B 3/00; B26B 5/00
See application file for complete search history.

(56) **References Cited**

U.S. PATENT DOCUMENTS

D301,770 S *	6/1989	Bethany	D28/68
D312,328 S *	11/1990	Page	D28/68
D327,125 S *	6/1992	Iten	D24/146
D329,699 S *	9/1992	Schutte	D24/133
D514,916 S *	2/2006	Craig	D8/102
7,818,885 B2 *	10/2010	Lafauci	A61B 17/3211 30/294
D633,616 S *	3/2011	Lafauci	D24/147
D637,883 S *	5/2011	Yu Chen	D8/98
D788,303 S *	5/2017	Yurek	D24/147

* cited by examiner

Primary Examiner — Philip S Hyder

(74) *Attorney, Agent, or Firm* — Bereskin & Parr LLP

(57) **CLAIM**

The ornamental design for a blade holder, as shown and described.

DESCRIPTION

FIG. 1 is an isometric view of a blade holder in accordance with a first embodiment of my new design;
 FIG. 2 is a top plan view of the blade holder of FIG. 1;
 FIG. 3 is a bottom plan view of the blade holder of FIG. 1;
 FIG. 4 is a left side elevation view of the blade holder of FIG. 1;
 FIG. 5 is a right side elevation view of the blade holder of FIG. 1;
 FIG. 6 is a front elevation view of the blade holder of FIG. 1;
 FIG. 7 is a rear elevation view of the blade holder of FIG. 1;
 FIG. 8 is an isometric view of a blade holder in accordance with a second embodiment of my new design;
 FIG. 9 is a top plan view of the blade holder of FIG. 8;
 FIG. 10 is a bottom plan view of the blade holder of FIG. 8;
 FIG. 11 is a left side elevation view of the blade holder of FIG. 8;
 FIG. 12 is a right side elevation view of the blade holder of FIG. 8;
 FIG. 13 is a front elevation view of the blade holder of FIG. 8; and,
 FIG. 14 is a rear elevation view of the blade holder of FIG. 8.

The portions shown in stippled lines do not form part of the design.

1 Claim, 8 Drawing Sheets





FIG. 1

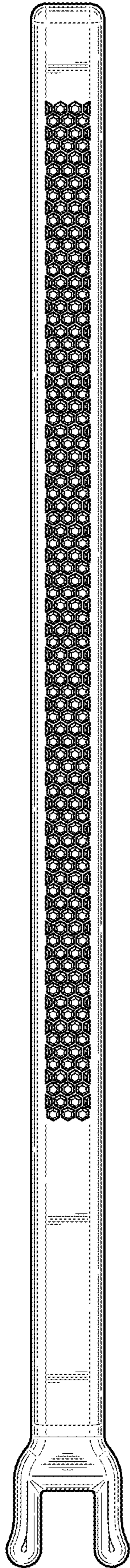

FIG. 2

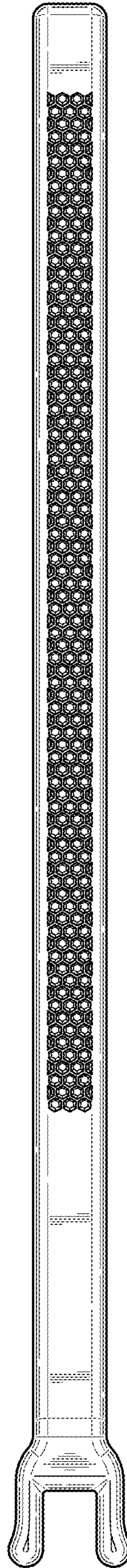

FIG. 3

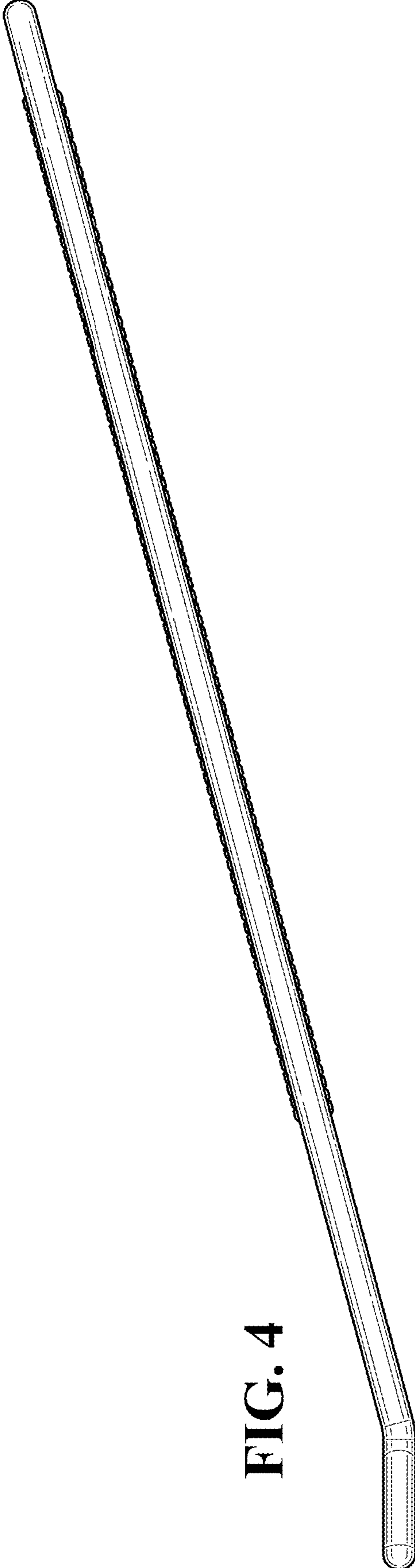

FIG. 4

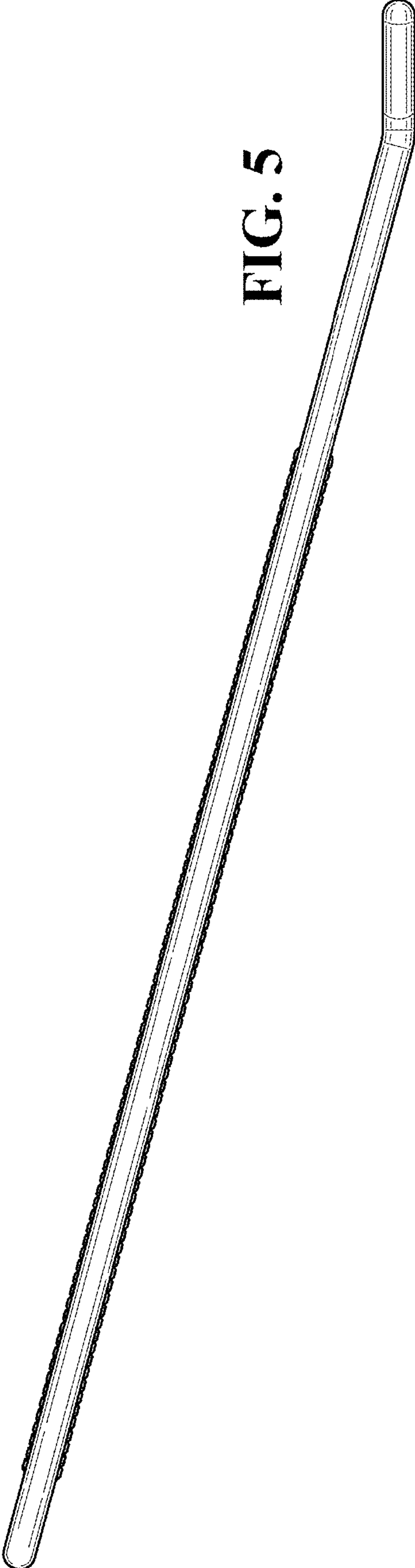

FIG. 5

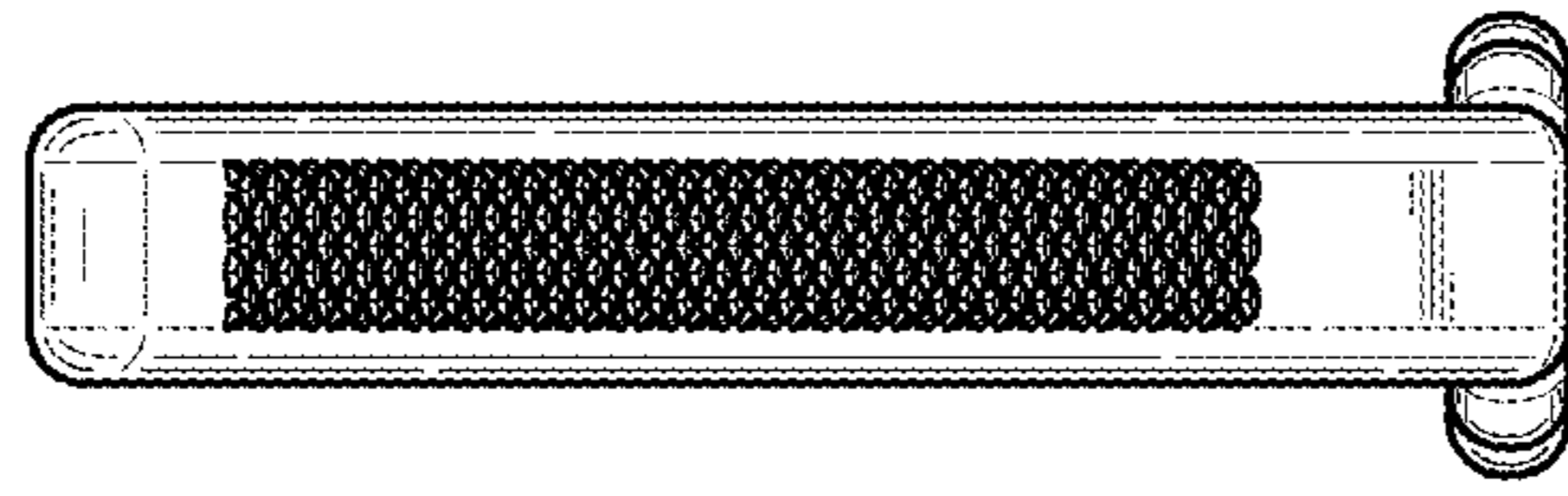

FIG. 7

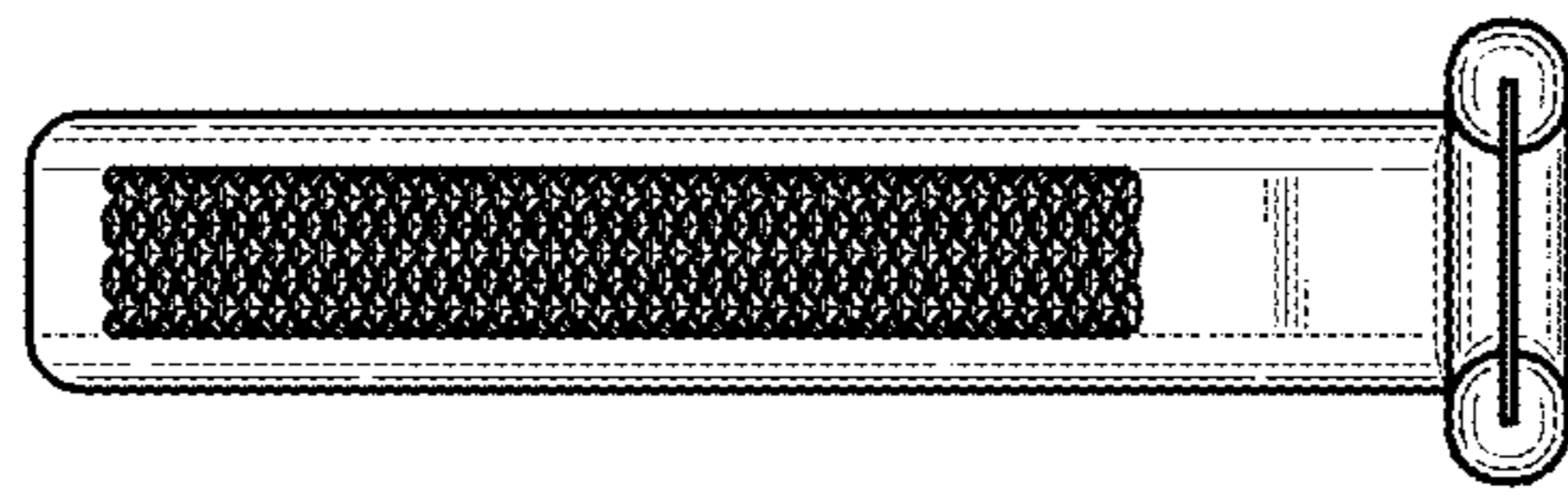

FIG. 6

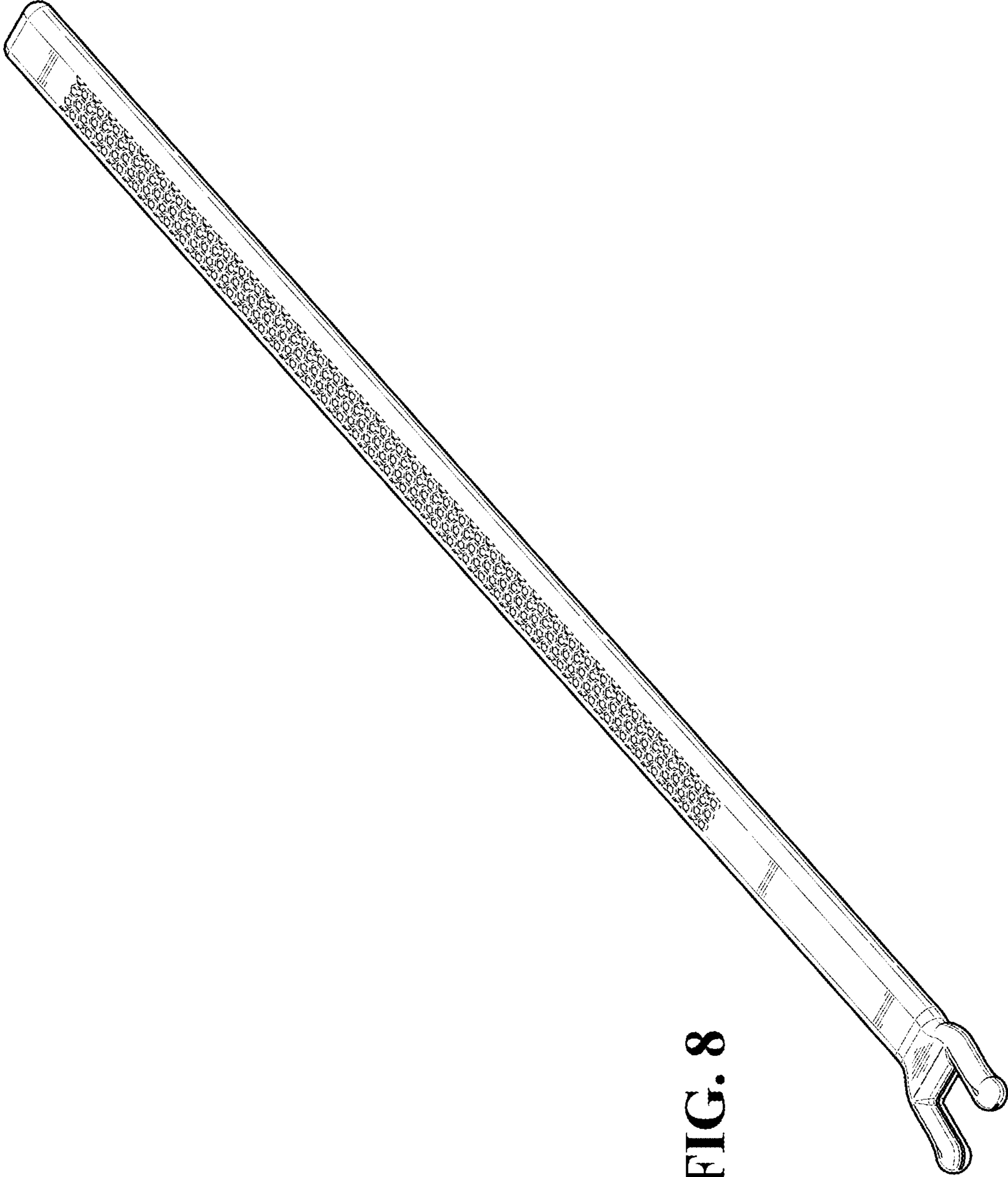

FIG. 8

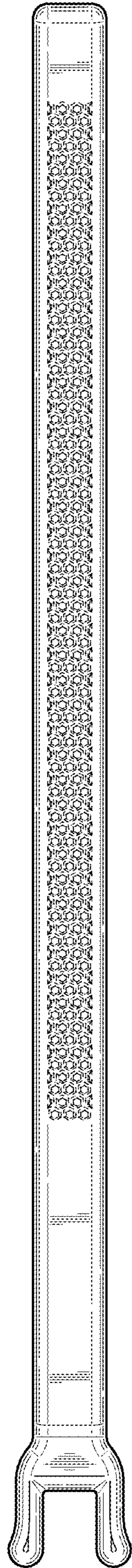

FIG. 9

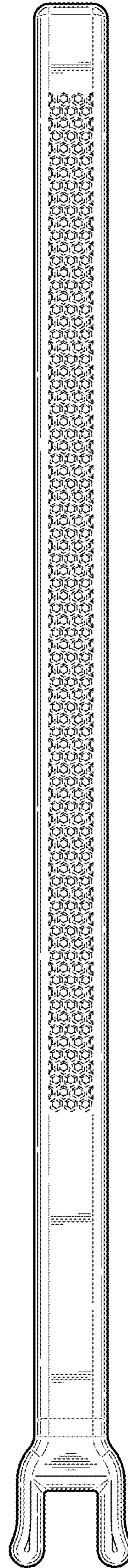

FIG. 10

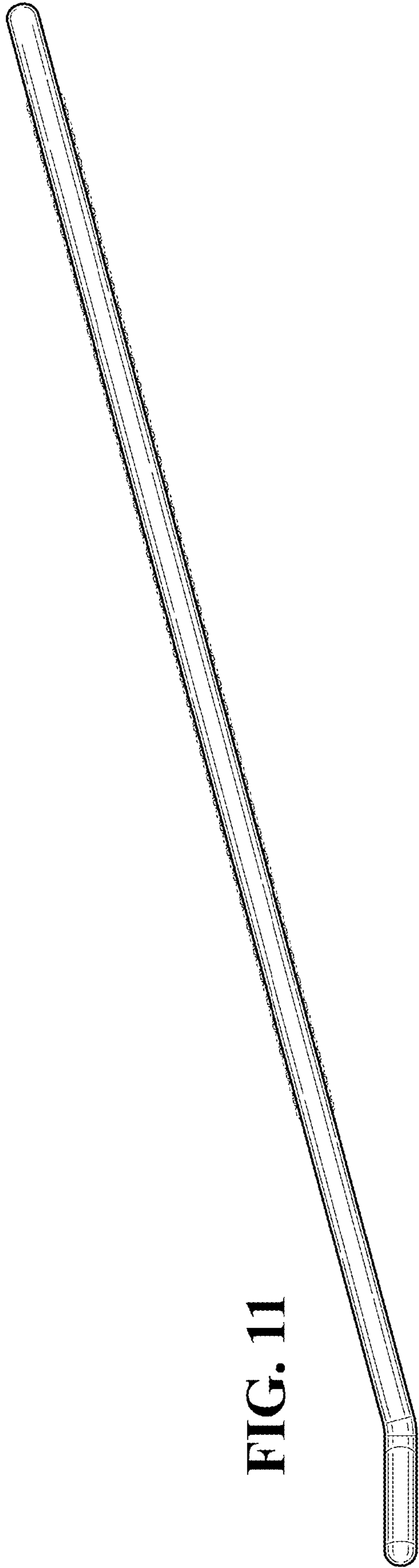

FIG. 11

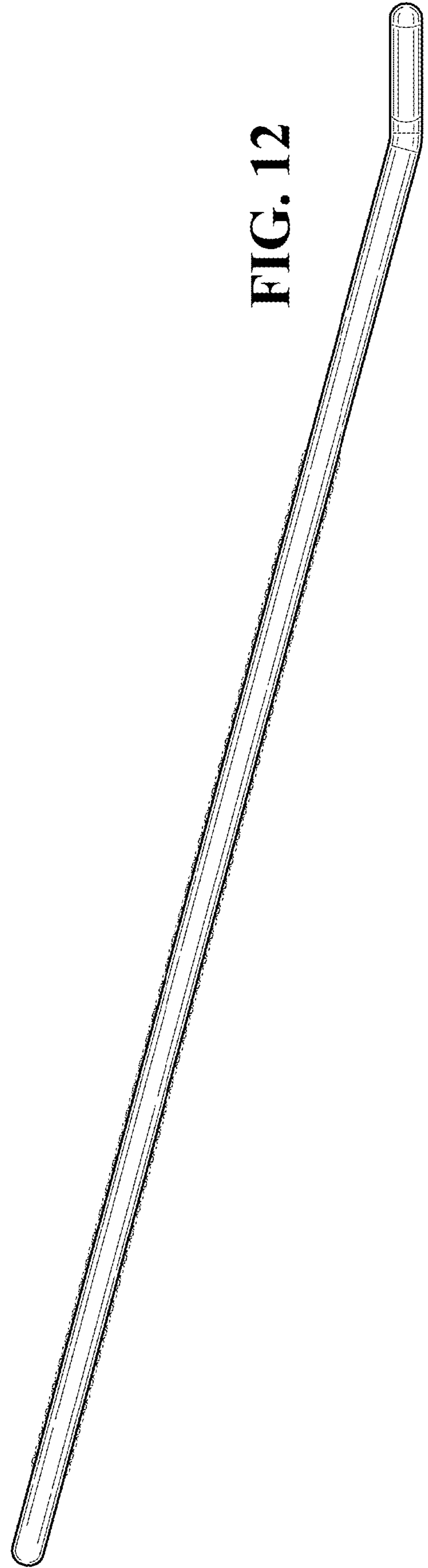

FIG. 12

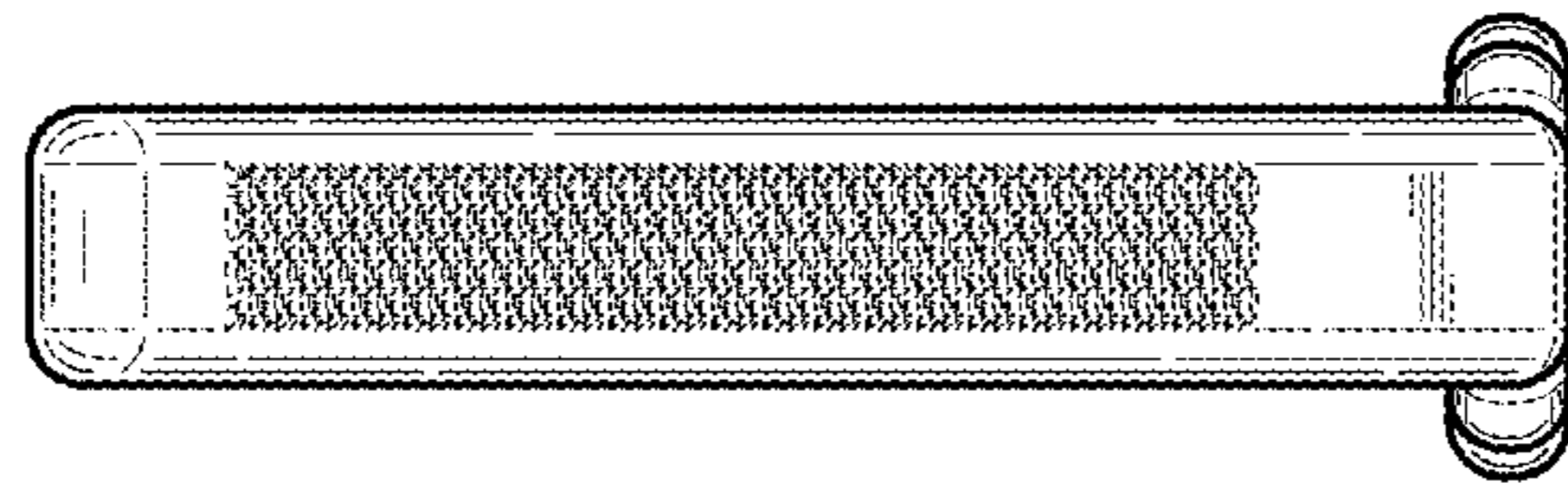

FIG. 14

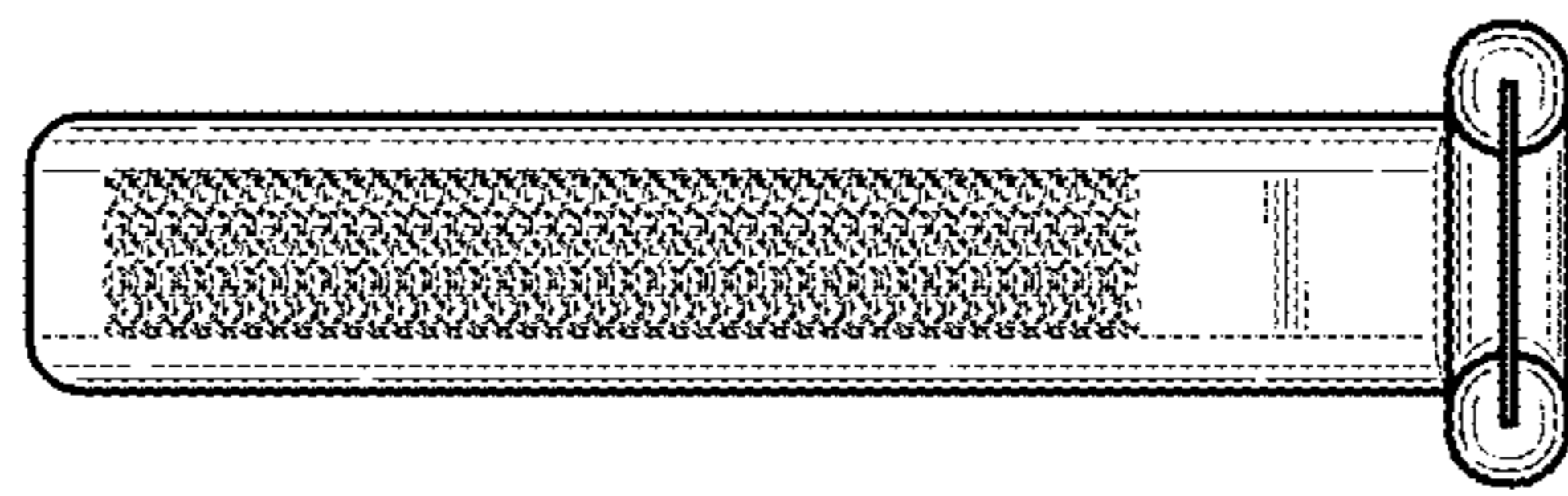

FIG. 13