



US00D928954S

(12) **United States Design Patent** (10) **Patent No.:** **US D928,954 S**  
**Kwon et al.** (45) **Date of Patent:** **\*\* Aug. 24, 2021**

(54) **CLAMP FOR SURGICAL INSTRUMENT**

(56) **References Cited**

(71) Applicant: **KOH YOUNG TECHNOLOGY INC.,**  
Seoul (KR)

U.S. PATENT DOCUMENTS

(72) Inventors: **Young Sik Kwon, Ansan-si (KR); Sung Mok Kim, Yongin-si (KR)**

D533,664	S	*	12/2006	Buttler	.....	D24/140
D573,711	S	*	7/2008	Johnson	.....	D24/133
D619,711	S	*	7/2010	Lombardo	.....	D24/143
D649,641	S	*	11/2011	Guttulrud	.....	D24/143
D659,827	S	*	5/2012	Stringham	.....	D24/143
D709,190	S	*	7/2014	Gilreath	.....	D24/133
D756,515	S	*	5/2016	Chin	.....	D24/135
10,433,828	B2	*	10/2019	Cote	.....	A61F 9/00736

(73) Assignee: **KOH YOUNG TECHNOLOGY INC.,**  
Seoul (KR)

\* cited by examiner

(\*\*) Term: **15 Years**

*Primary Examiner* — Wan Laymon

(21) Appl. No.: **29/686,579**

*Assistant Examiner* — Clint A Samuel

(22) Filed: **Apr. 5, 2019**

(74) *Attorney, Agent, or Firm* — Hamre, Schumann,  
Mueller & Larson, P.C.

(30) **Foreign Application Priority Data**

(57) **CLAIM**

Oct. 5, 2018 (KR) ..... 30-2018-0046059

The ornamental design for a clamp for surgical instrument,  
as shown and described.

(51) **LOC (13) Cl.** ..... **24-02**

**DESCRIPTION**

(52) **U.S. Cl.**  
USPC ..... **D24/143**

(58) **Field of Classification Search**  
USPC ..... D24/107, 128, 133, 135, 140, 143, 146,  
D24/147, 149, 155, 171; 606/53, 87, 96,  
606/98, 102, 167; 600/218; D8/71, 72  
CPC ..... A61B 17/00; A61B 17/15; A61B 17/17;  
A61B 17/32; A61B 17/1775; A61B  
34/10; A61B 34/20; A61F 2002/4687;  
A61M 2025/024; A61M 25/00; A61M  
25/02; A61M 5/1418

FIG. 1 is a perspective view of a clamp for surgical instru-  
ment showing our new design;  
FIG. 2 is a front elevational view thereof;  
FIG. 3 is a rear elevational view thereof;  
FIG. 4 is left side view thereof;  
FIG. 5 is a right side view thereof;  
FIG. 6 is a top plan view thereof; and,  
FIG. 7 is a bottom plan view thereof.  
The broken line in FIG. 7 is included for the purpose of  
illustrating a portion of the clamp for surgical instrument and  
forms no part of the claimed design.

See application file for complete search history.

**1 Claim, 7 Drawing Sheets**

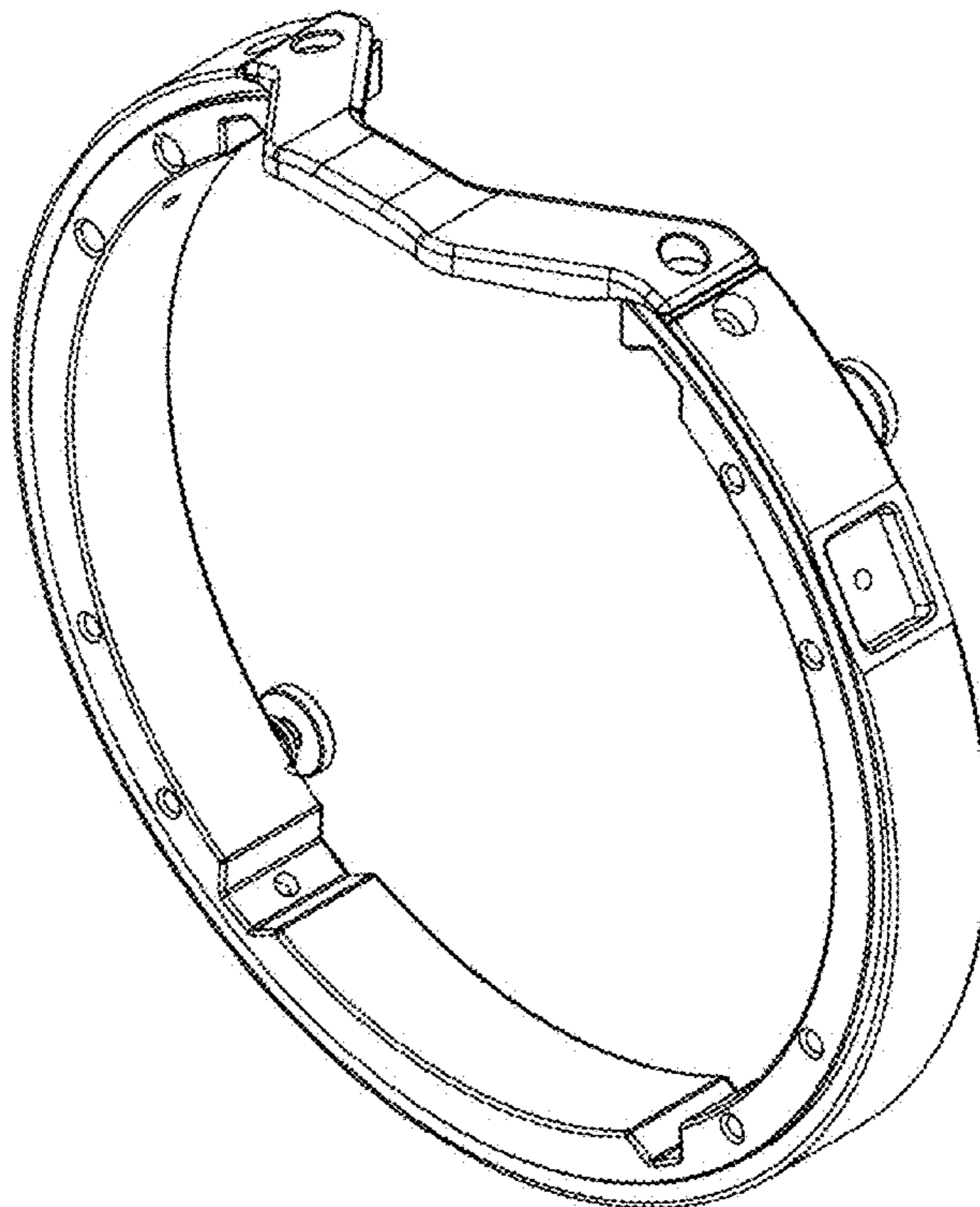

Fig. 1

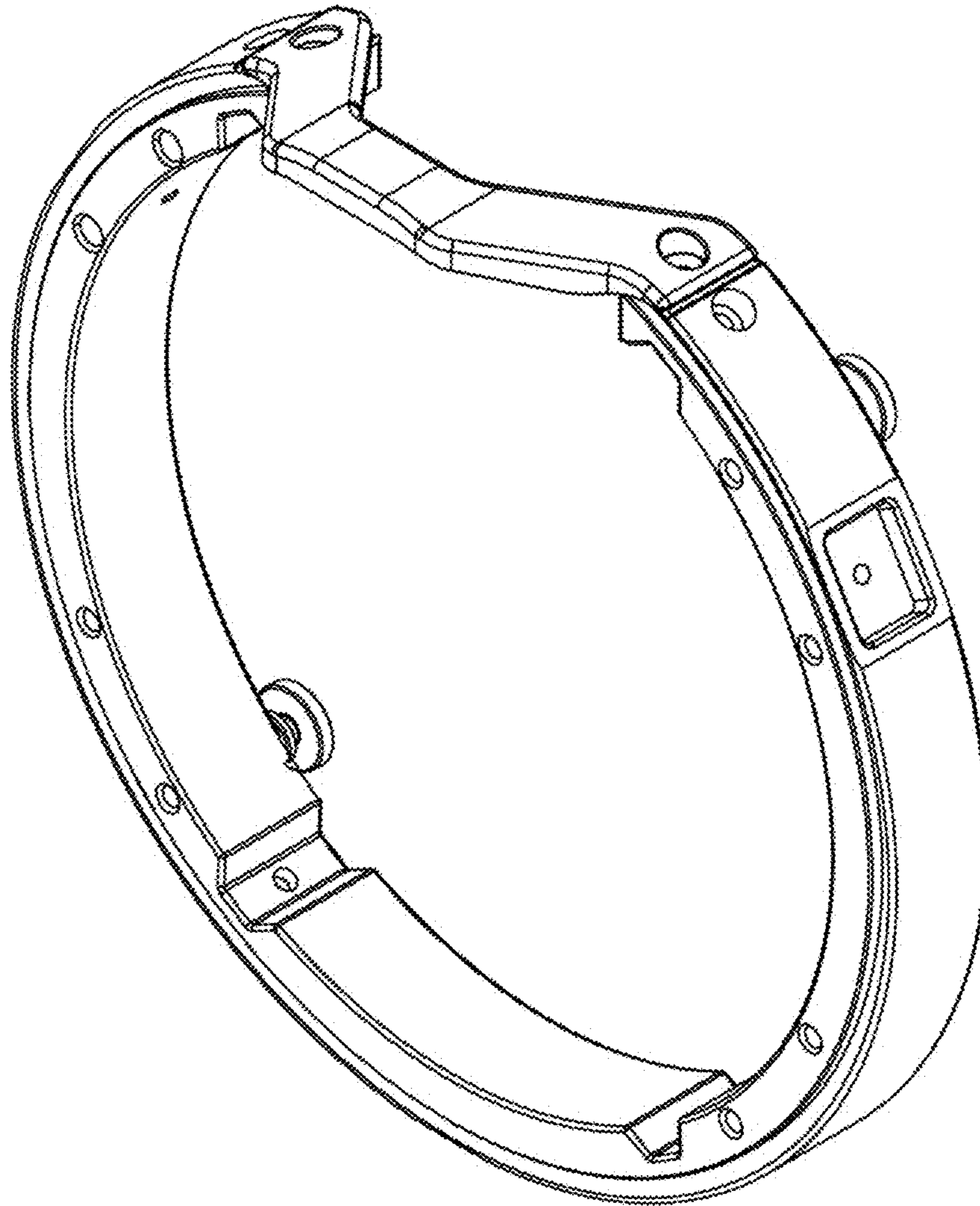

Fig. 2

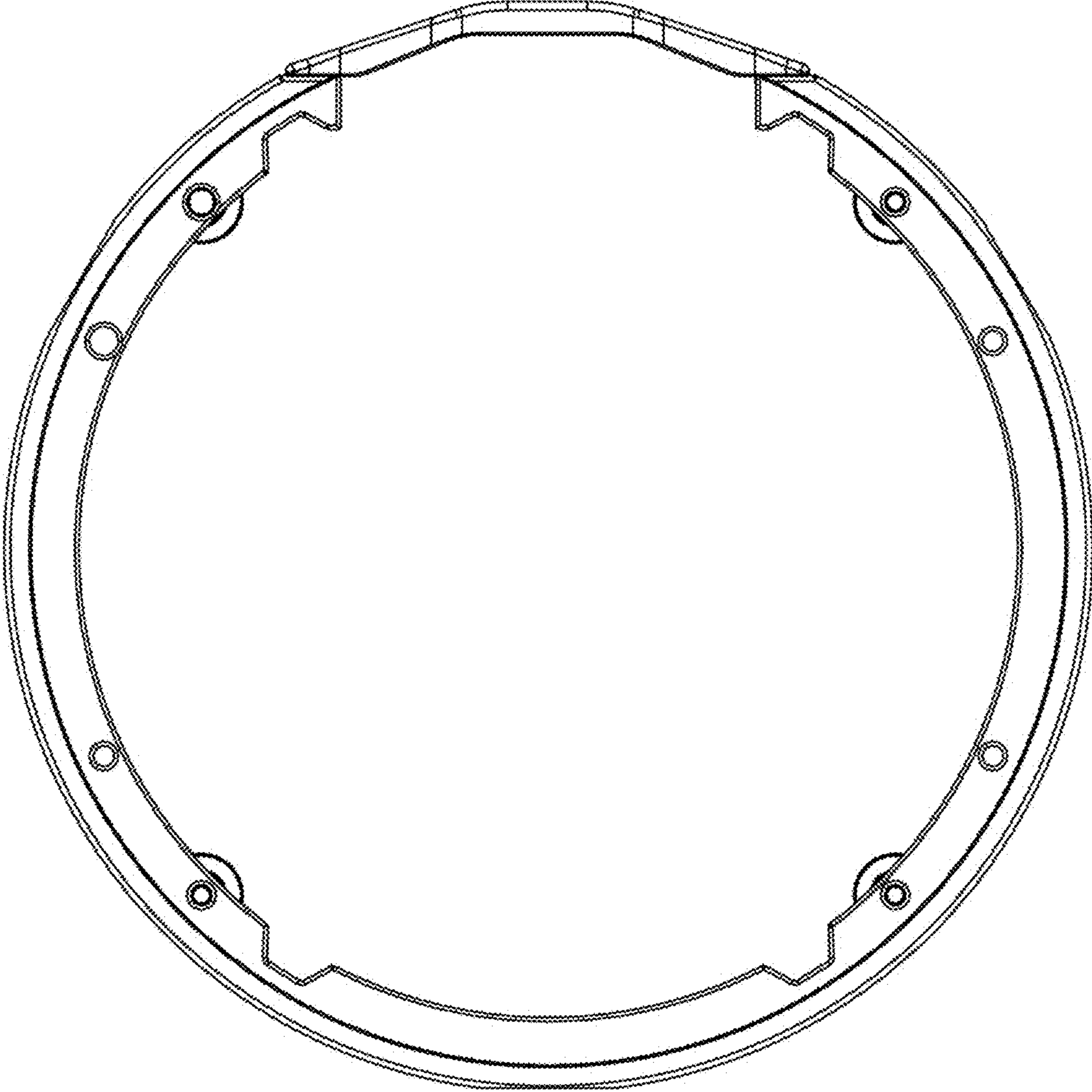

Fig. 3

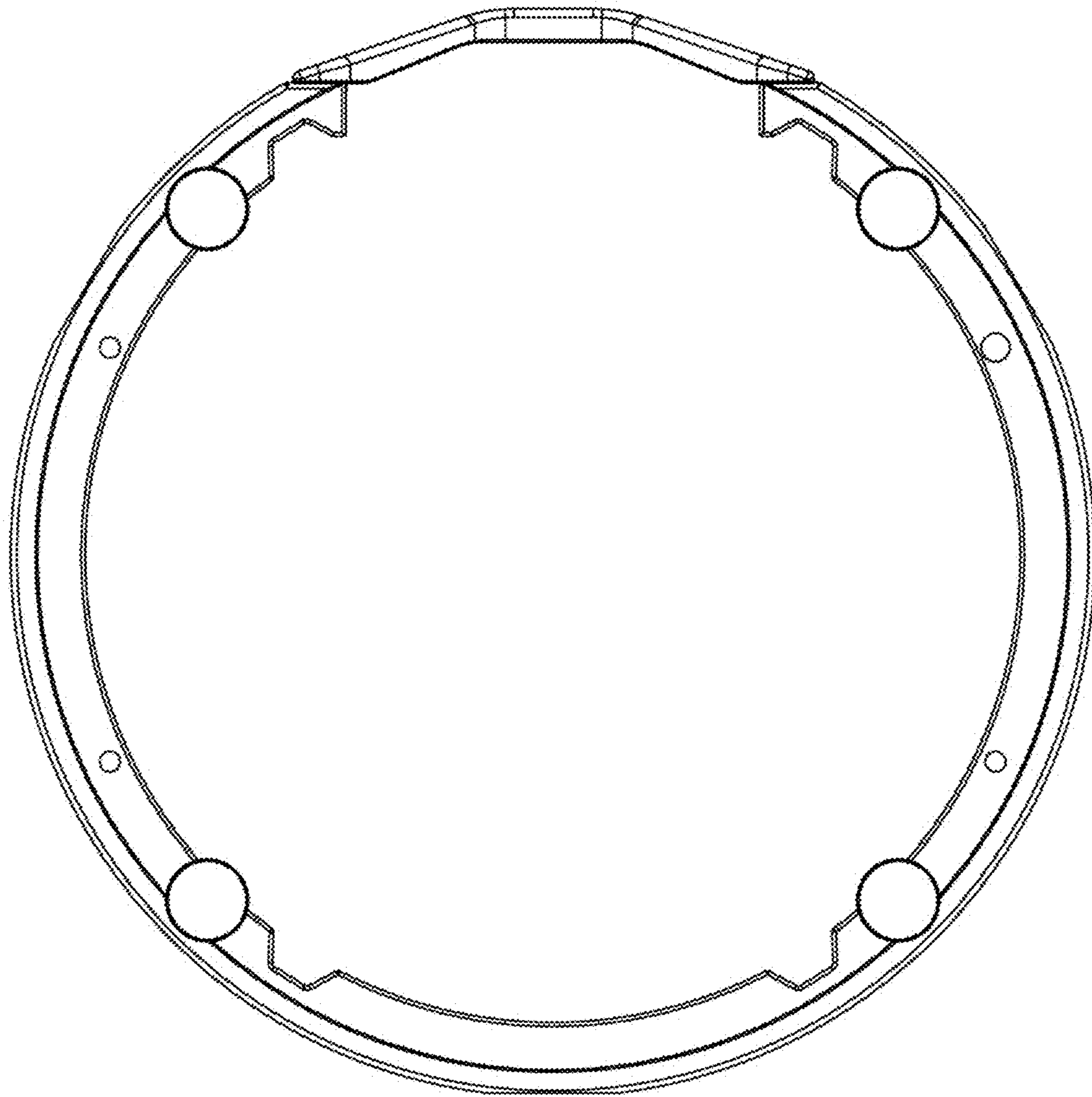

Fig. 4

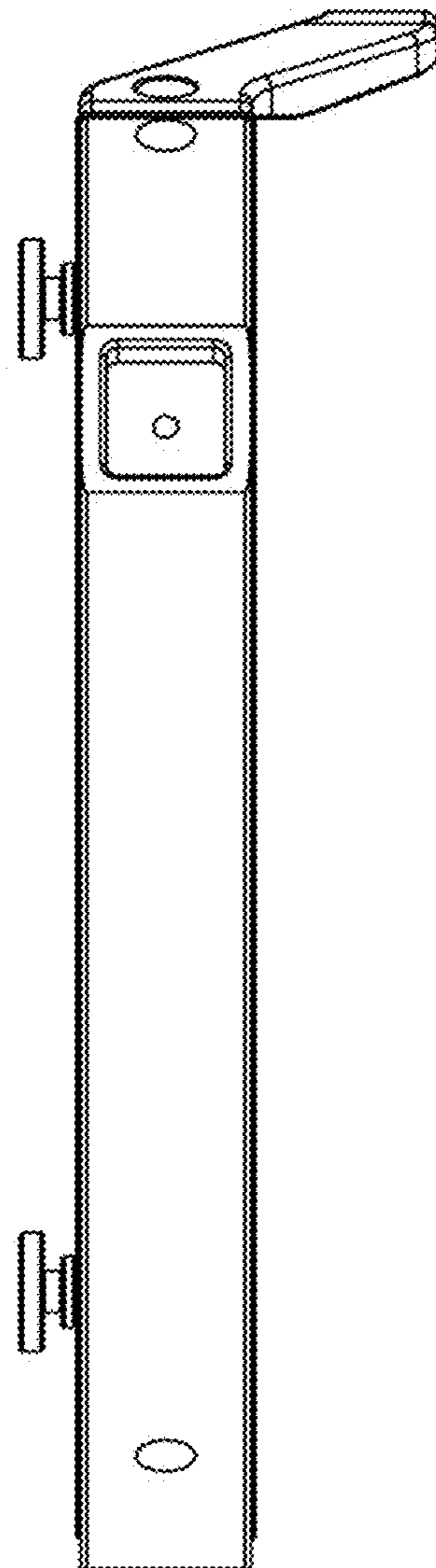

Fig. 5

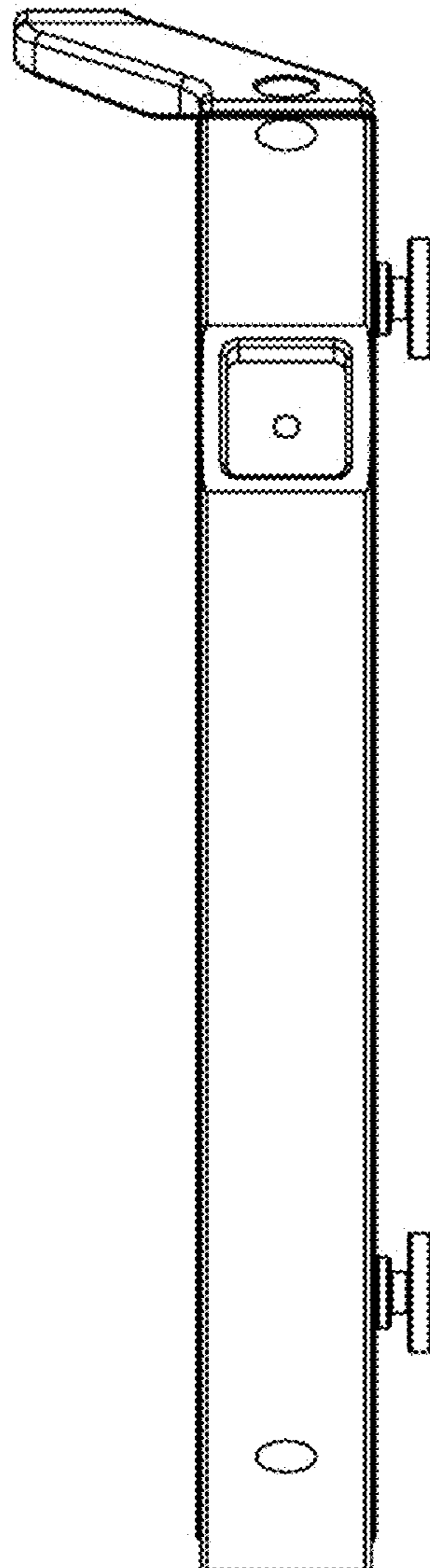

Fig. 6

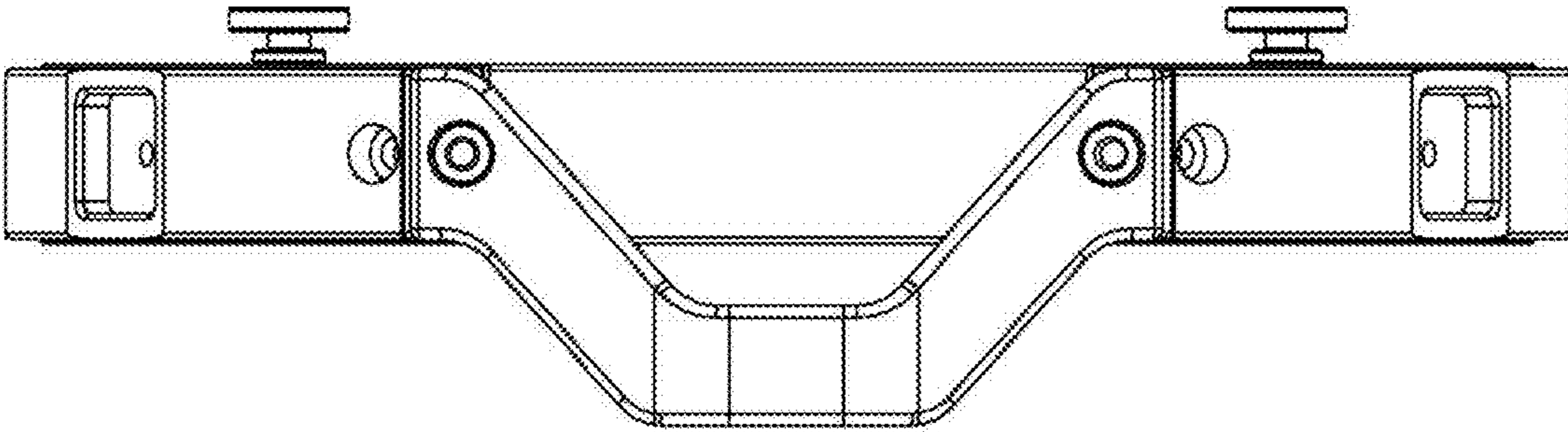

Fig. 7

