



US00D928945S

(12) **United States Design Patent**
Ajaelo

(10) **Patent No.:** **US D928,945 S**

(45) **Date of Patent:** **** Aug. 24, 2021**

- (54) **EYE DROP DISPENSER**
- (71) Applicant: **Ikem Ajaelo**, Fremont, CA (US)
- (72) Inventor: **Ikem Ajaelo**, Fremont, CA (US)
- (**) Term: **15 Years**
- (21) Appl. No.: **29/688,755**
- (22) Filed: **Apr. 24, 2019**
- (51) **LOC (13) Cl.** **24-02**
- (52) **U.S. Cl.**
USPC **D24/120; D24/115**
- (58) **Field of Classification Search**
USPC D24/107, 108, 110, 110.4–110.6,
D24/111–115, 117–122, 123, 130, 133,
D24/141, 152, 186, 215, 116; D28/7, 8;
D7/667, 669, 700, 523; D9/436, 439,
D9/440, 447, 723, 435, 444, 521, 529,
D9/549, 558, 574, 575, 686, 687, 688,
D9/689, 690, 691, 692, 693, 694;
D23/200; D11/152–154
CPC A61F 9/0008; A61F 9/0026; A61F
2230/0091; A61F 2250/0004; B65D
47/18; B65D 83/30; B01L 3/0282; A61H
35/02; A61H 2201/0153; A61M 35/003;
A61M 35/00; A61M 2210/0612
See application file for complete search history.

- 3,279,466 A * 10/1966 Mings A61F 9/0026
604/302
- D248,448 S * 7/1978 McClure D24/115
- 4,111,200 A * 9/1978 Sbarra A61F 9/0026
604/298
- D257,107 S * 9/1980 Daenen D7/586
- D293,474 S * 12/1987 Jermyn D24/115
- 4,834,728 A * 5/1989 McKenna A61F 9/0026
222/192

(Continued)

OTHER PUBLICATIONS

I-Bubble, [site visited Aug. 31, 2020] Available from Internet. URL:
<https://www.behance.net/gallery/69854169/I-BUBBLE-Electronic-Eye-Drop-Dispenser> (Year: 2020).*

Primary Examiner — T Chase Nelson
Assistant Examiner — Kelly L Gross

(57) **CLAIM**

The ornamental design for an eye drop dispenser, as shown and described.

DESCRIPTION

FIG. 1 is an isometric top view of an eye drop dispenser showing its new design;
FIG. 2 is an isometric bottom view thereof;
FIG. 3 is a top plan view thereof;
FIG. 4 is a front elevation view thereof, the rear side elevation view being a mirror image thereof;
FIG. 5 is a left side elevation view thereof, the right side elevation view being a mirror image thereof;
FIG. 6 is a bottom plan view thereof; and,
FIG. 7 is an isometric top view of an eye drop dispenser showing an optional cover in the open position thereof.
The broken lines of FIGS. 1, 3 and 7 illustrate portions of the eye drop dispenser that form no part of the claimed design. The broken line arrows of FIG. 7 show the order of assembly.

1 Claim, 7 Drawing Sheets

(56) **References Cited**

U.S. PATENT DOCUMENTS

- D132,608 S * 6/1942 Steelman D24/120
- 2,375,636 A * 5/1945 Eddins 604/295
- 2,516,818 A * 7/1950 West A61F 9/0008
604/298
- 2,585,264 A * 2/1952 Mock A61H 35/02
604/301
- 2,785,321 A * 3/1957 Imler H03H 9/0528
310/344
- 2,920,624 A * 1/1960 Lerner A61F 9/0026
604/301

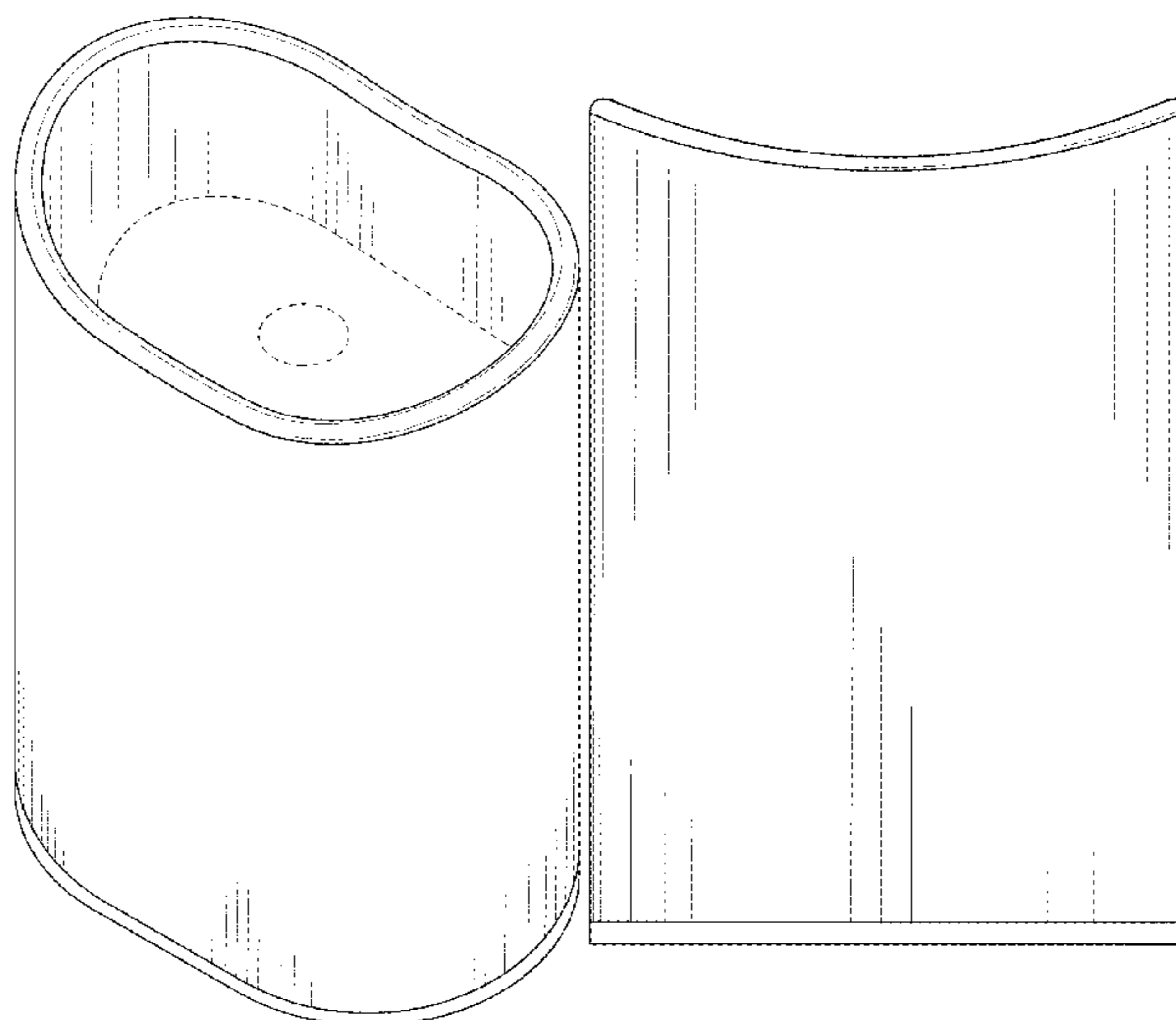

(56)

References Cited

U.S. PATENT DOCUMENTS

4,960,407	A *	10/1990	Cope	A61B 17/0231				
					604/300				
D341,315	S *	11/1993	Seymour	D9/529				
D352,663	S *	11/1994	Suxdorf	D9/449				
5,382,243	A *	1/1995	Mulholland	A61F 9/0026				
					222/36				
D355,844	S *	2/1995	Bishop	D24/114				
D367,230	S *	2/1996	Paglina	D9/529				
D377,091	S *	12/1996	Scott, Sr.	D24/121				
5,611,788	A *	3/1997	Marchment	A61F 9/0008				
					604/295				
5,644,298	A *	7/1997	Brooks	A47G 23/16				
					206/534				
D382,446	S *	8/1997	Bacon	D7/509				
D439,545	S *	3/2001	Grosfillex	D11/152				
D446,499	S *	8/2001	Andre	D13/110				
6,309,717	B1 *	10/2001	Qiu	B32B 29/00				
					138/141				
D463,319	S *	9/2002	Stern	D11/144				
6,508,793	B1 *	1/2003	Harrold	A61F 9/0008				
					604/294				
D470,361	S *	2/2003	Trombly	D7/509				
D477,998	S *	8/2003	Cummings	D9/729				
D481,952	S *	11/2003	Orsomando	D9/529				
D484,806	S *	1/2004	Cummings	D9/529				
D488,069	S *	4/2004	Badya	D9/529				
D517,852	S *	3/2006	Jalet	D7/300				
D540,123	S *	4/2007	George	D7/602				
D546,939	S *	7/2007	Collins	D24/110				
D599,309	S *	9/2009	Guerrero	D13/182				
D602,740	S *	10/2009	Urquiola	D7/509				
D603,573	S *	11/2009	Ghiorghie	D34/1				
D628,490	S *	12/2010	Sato	D9/529				
D634,669	S *	3/2011	Brandstatter	D11/152				
D660,993	S *	5/2012	Halty	D26/9				
D660,994	S *	5/2012	Halty	D26/9				
D693,919	S *	11/2013	Miu	D24/107				
D694,402	S *	11/2013	Lensch	D24/120				
D694,403	S *	11/2013	Lensch	D24/120				
D707,558	S *	6/2014	Corradini	D9/436				
D717,666	S *	11/2014	Palm	D9/694				
D732,394	S *	6/2015	DeMarco	D9/529				
D732,828	S *	6/2015	Thompson	D3/315				
9,072,580	B2 *	7/2015	Alvino	A61H 35/02				
9,227,044	B2 *	1/2016	Bansal	A61K 31/568				
D750,788	S *	3/2016	Chang	D24/188				
D752,287	S *	3/2016	Bansal	D28/7				
D752,982	S *	4/2016	Sawicki	D9/516				
D753,492	S *	4/2016	Sawicki	D9/516				
D754,131	S *	4/2016	Shim	D14/436				
D763,576	S *	8/2016	Leblanc	D3/301				
D764,871	S *	8/2016	Touchet	D7/587				
D768,293	S *	10/2016	Sawicki	D24/119				
9,475,634	B2 *	10/2016	Prischak	B65D 83/40				
D772,400	S *	11/2016	Sawicki	D24/119				
D774,762	S *	12/2016	Aller	D3/304				
D814,023	S *	3/2018	Burgman	D24/120				
D819,137	S *	5/2018	Mackler	D20/41				
9,999,540	B2 *	6/2018	Yang	A61F 9/0008				
10,039,667	B2 *	8/2018	Morgan	A61M 3/0208				
D829,555	S *	10/2018	Kokubo	D9/516				
D829,892	S *	10/2018	Brana	D24/120				
D840,821	S *	2/2019	Kokubo	D9/529				
D841,152	S *	2/2019	Naylor	D24/120				
D841,153	S *	2/2019	Kokubo	D24/127				
D852,351	S *	6/2019	Alvino	D24/120				
10,449,343	B2 *	10/2019	Chang	B05B 11/3052				
D869,284	S *	12/2019	Laughlin	D9/572				
D875,946	S *	2/2020	Abelson	D24/172				
10,561,577	B2 *	2/2020	Shinoda	A61H 35/02				
D882,075	S *	4/2020	Kokubo	D24/127				
D897,678	S *	10/2020	Koh	D3/294				
D898,990	S *	10/2020	Liu	D27/162				
D899,261	S *	10/2020	Madam	D9/574				
D900,385	S *	10/2020	Wang	D27/162				
D901,001	S *	11/2020	Finger	A61M 15/0085				
					D24/110				
D901,675	S *	11/2020	Ross	D24/111				
D901,711	S *	11/2020	Galen	D24/216				
D902,392	S *	11/2020	Scrimgeour	D24/113				
D902,734	S *	11/2020	Clark	D9/563				
D903,192	S *	11/2020	Chang	D27/162				
D903,861	S *	12/2020	Otsu	D24/119				
D908,278	S *	1/2021	Scatterday	A61M 15/0085				
					D27/162				
D910,911	S *	2/2021	Kim	A61M 15/0085				
					D27/167				
D911,181	S *	2/2021	Lee	D9/529				
D911,850	S *	3/2021	Lee	D9/529				
D912,309	S *	3/2021	Bowen	D27/162				
D914,276	S *	3/2021	Lai	D27/162				
D914,279	S *	3/2021	Jones	D27/162				
D914,503	S *	3/2021	Aboabdo	A61M 15/0085				
					D9/503				
D914,509	S *	3/2021	Matsuishi	D9/574				
D914,514	S *	3/2021	Wintroub	A61M 15/0085				
					D9/688				
D914,638	S *	3/2021	Laube	D14/207				
D915,582	S *	4/2021	Jiang	D24/123				
D916,274	S *	4/2021	Aktas	B65D 47/18				
					D24/110.5				
10,974,877	B2 *	4/2021	Kim	B65D 47/18				
2006/0129113	A1 *	6/2006	Merrick	A61F 9/0026				
					604/294				
2006/0253089	A1 *	11/2006	Lin	A61F 13/124				
					604/301				
2008/0208148	A1 *	8/2008	Soon	A61M 35/10				
					604/301				
2011/0024426	A1 *	2/2011	Kokubo	B65D 41/485				
					220/315				
2013/0096517	A1 *	4/2013	Leistner	B65B 3/006				
					604/298				
2018/0092772	A1 *	4/2018	Mosalam	A61F 9/0008				
2018/0098882	A1 *	4/2018	Ronda	A61F 9/0026				
2020/0206031	A1 *	7/2020	Lim	A61F 9/0008				

* cited by examiner

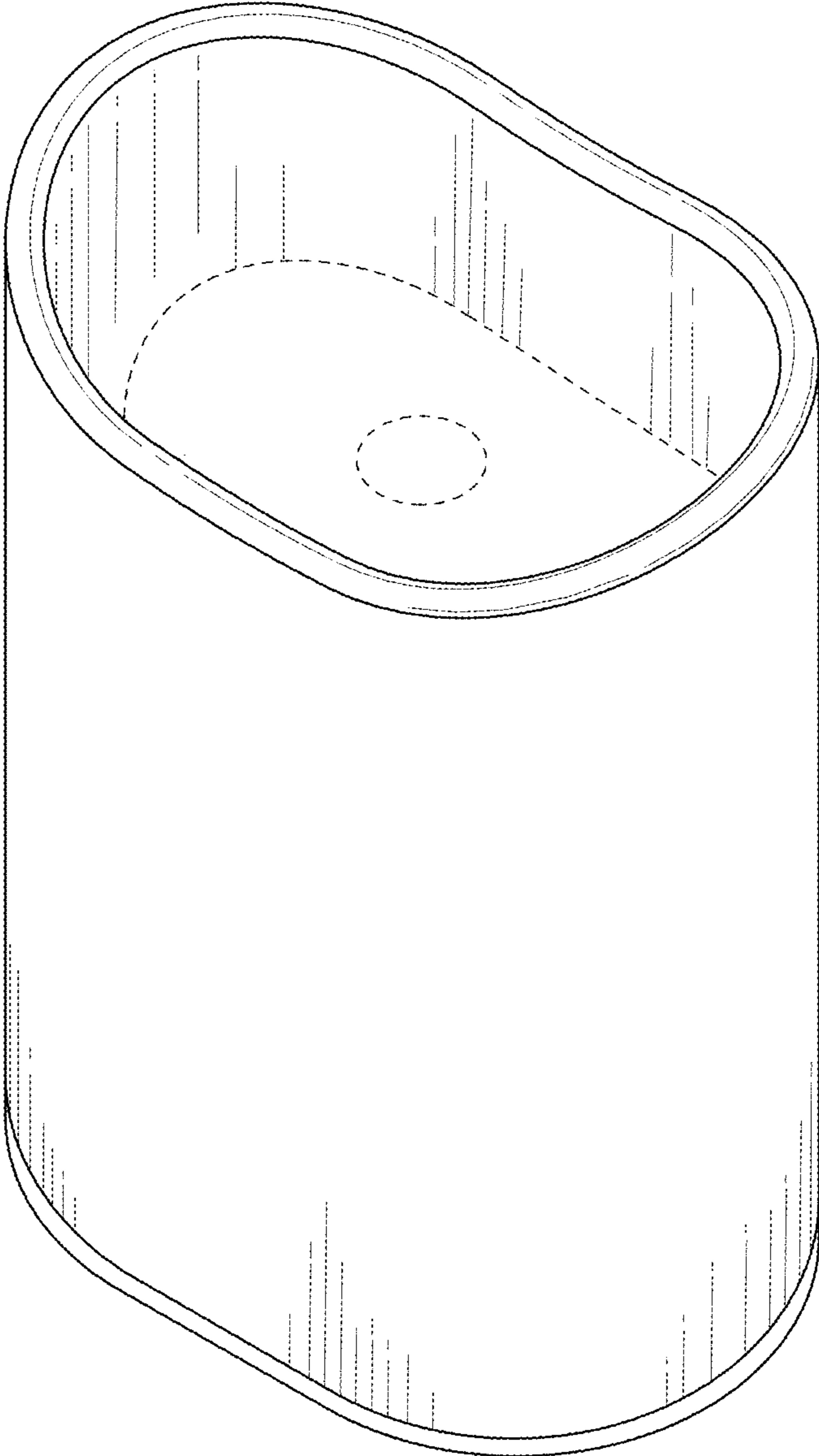

FIG. 1

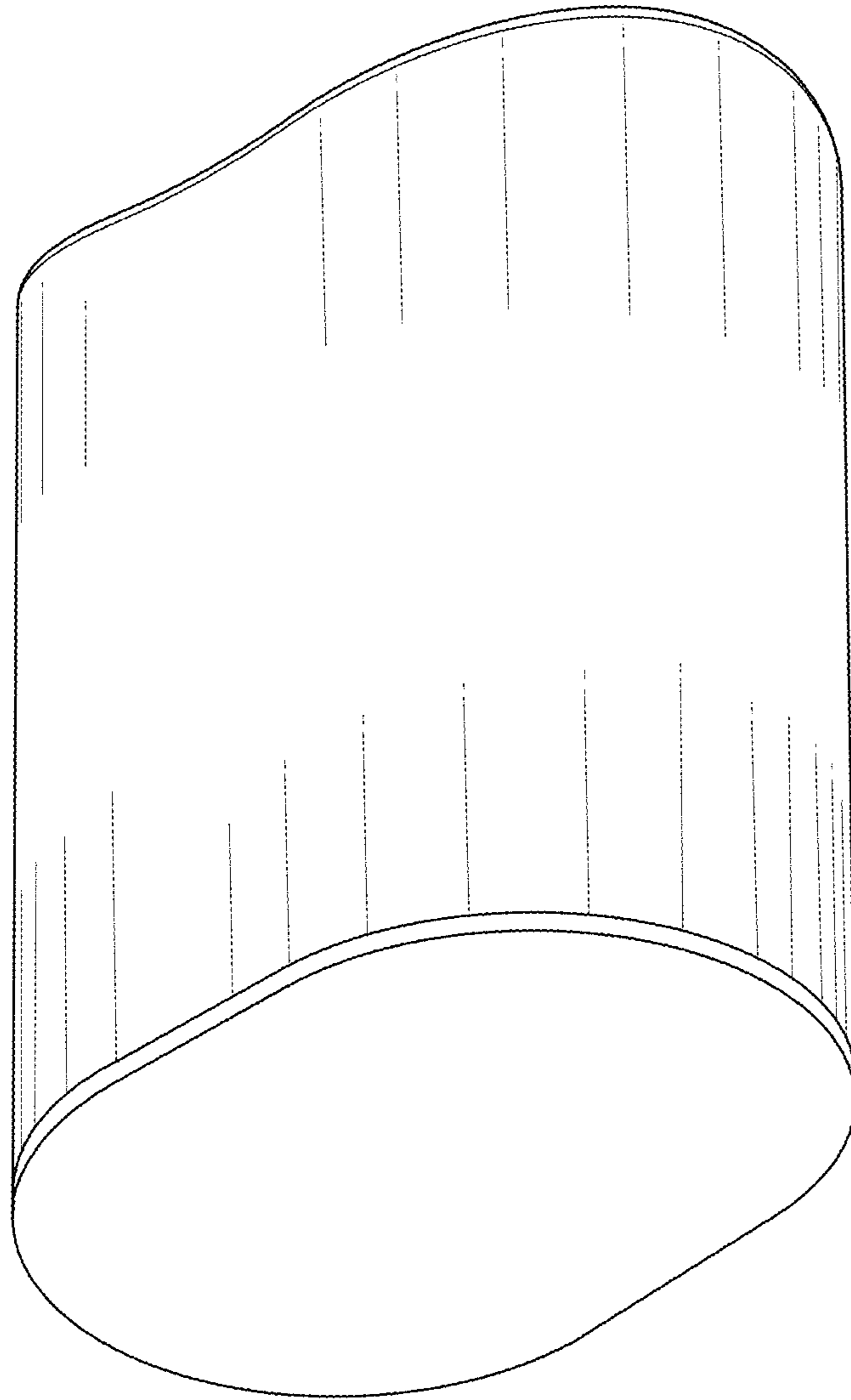

FIG. 2

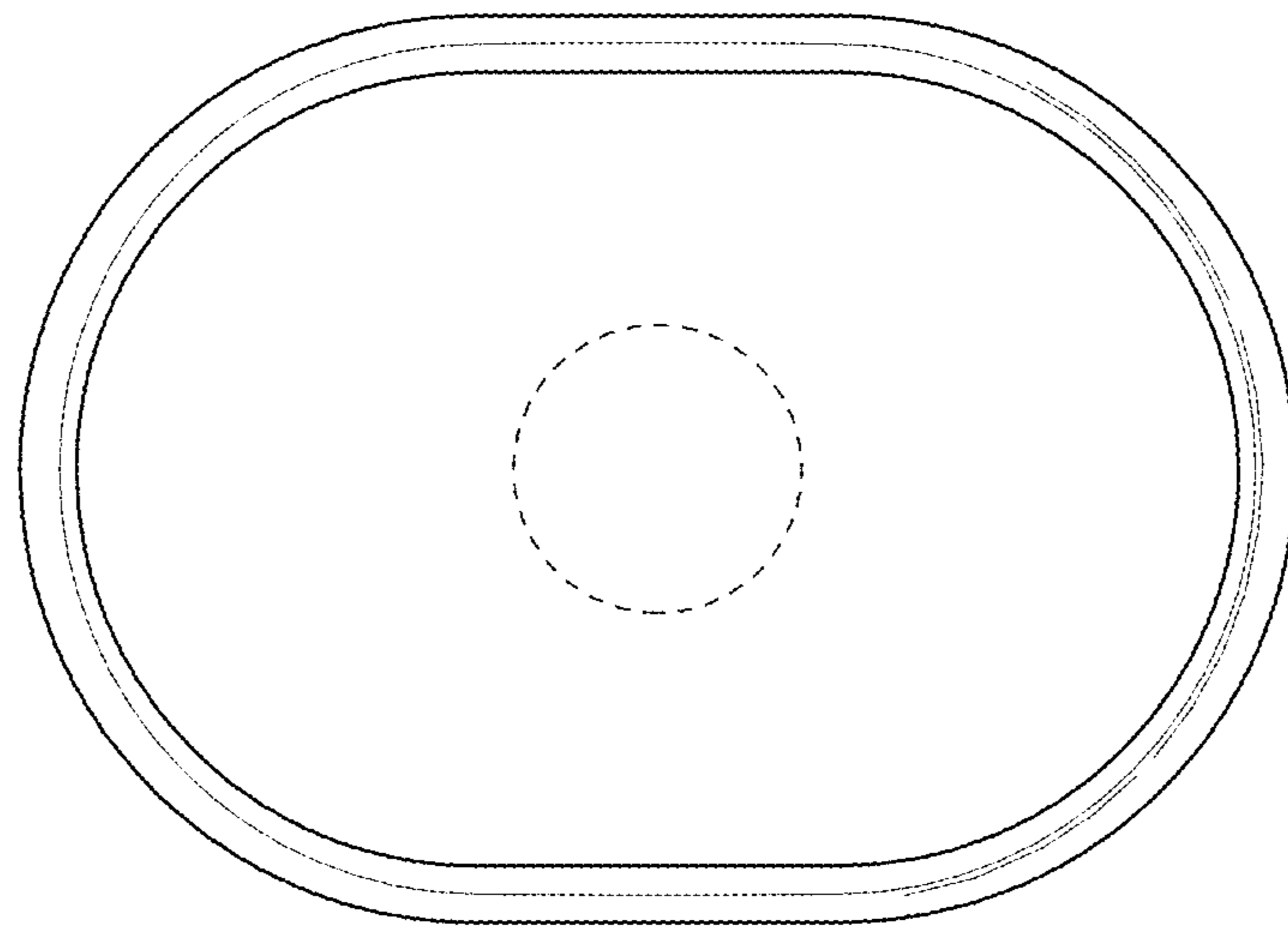

FIG. 3

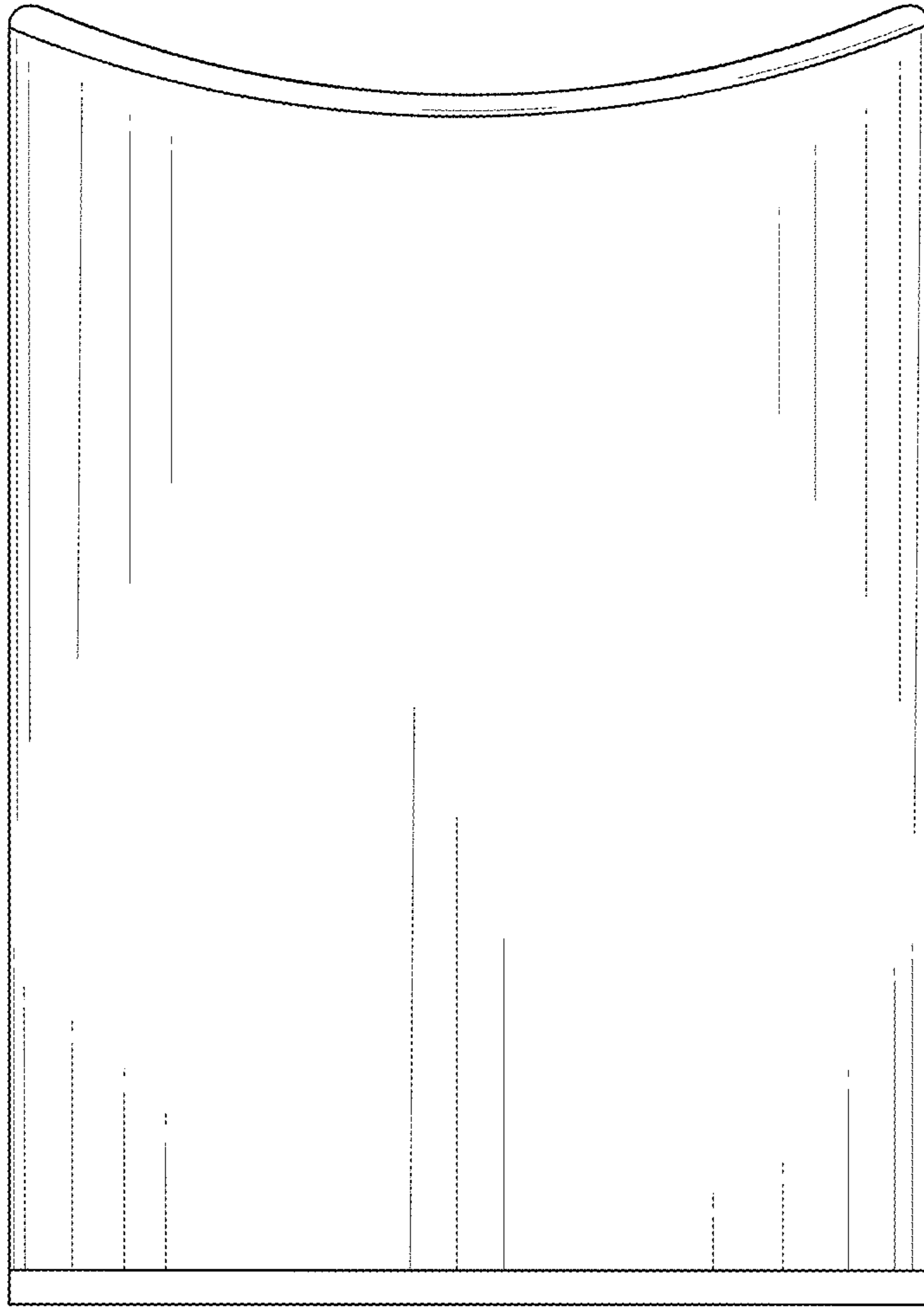

FIG. 4

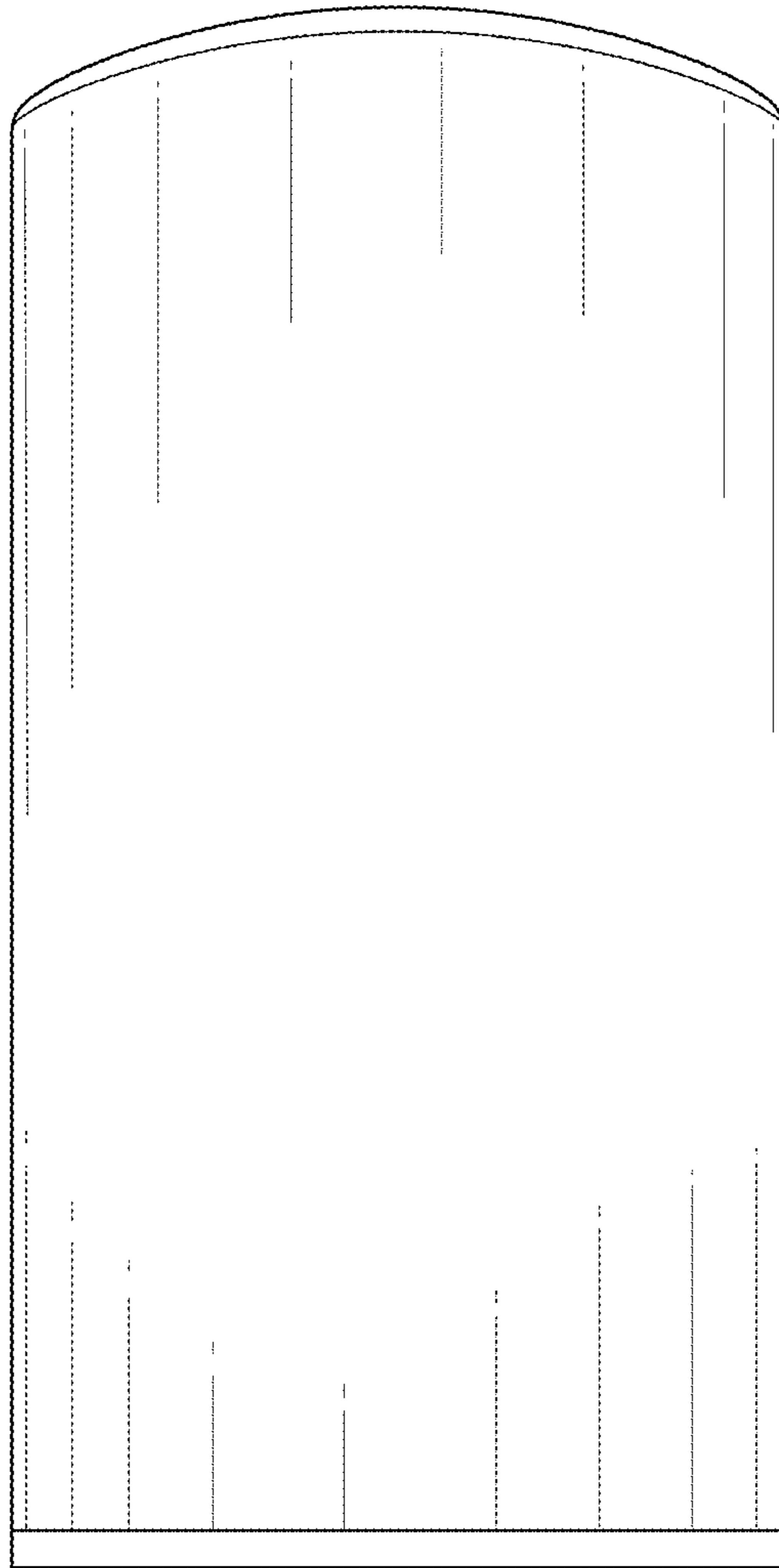

FIG. 5

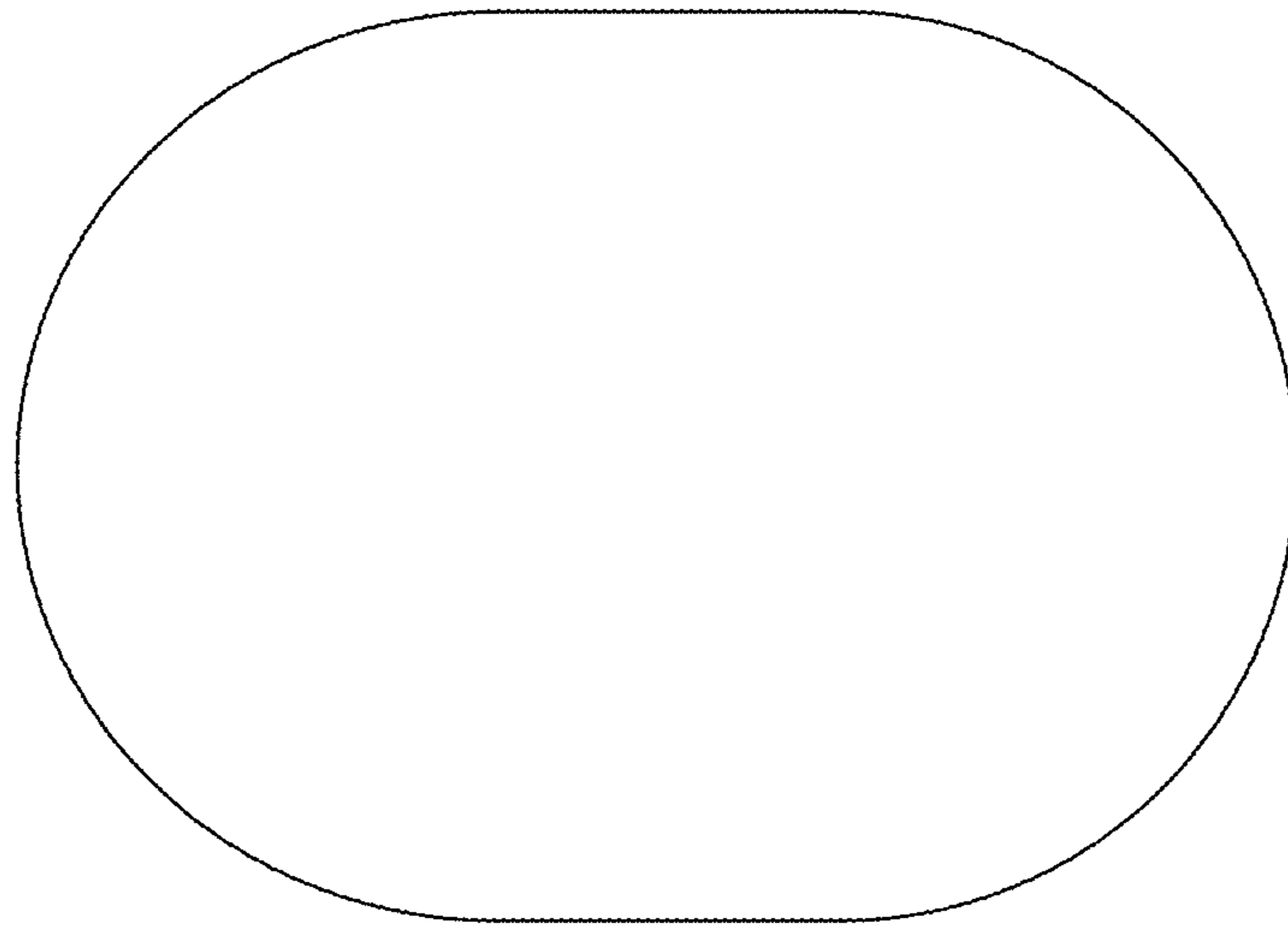

FIG. 6

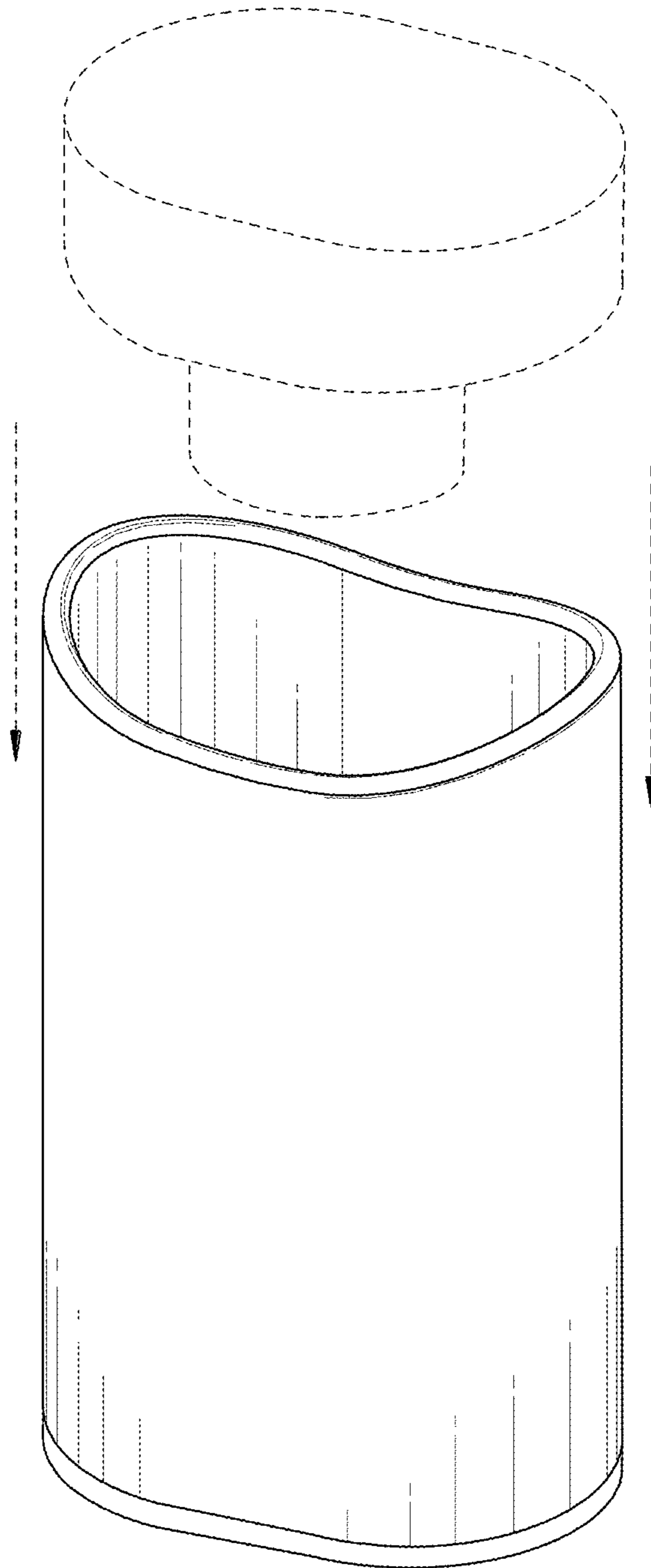

FIG. 7