



US00D928893S

(12) **United States Design Patent** (10) **Patent No.:** **US D928,893 S**
Razon (45) **Date of Patent:** **** Aug. 24, 2021**

(54) **YOGA BLOCK**
(71) Applicant: **Eli Razon**, Maple Glen, PA (US)
(72) Inventor: **Eli Razon**, Maple Glen, PA (US)
(**) Term: **15 Years**
(21) Appl. No.: **29/685,313**

D481,136 S * 10/2003 Dean D25/113
D487,553 S * 3/2004 Morikawa D6/601
D519,217 S * 4/2006 Eichner D25/119
D523,494 S * 6/2006 Van Straaten D21/662
D523,913 S * 6/2006 Van Straaten D21/662
D526,369 S * 8/2006 Van Straaten D21/662
D566,448 S * 4/2008 Ridder D24/183
D578,805 S * 10/2008 Diekman D6/601
D642,694 S * 8/2011 Sharps D24/190

(Continued)

(22) Filed: **Mar. 27, 2019**
(51) **LOC (13) Cl.** **21-02**
(52) **U.S. Cl.**
USPC **D21/686**
(58) **Field of Classification Search**
USPC D21/686, 690, 803, 809; D24/183, 184,
D24/190, 191, 234; D25/102, 112, 113,
D25/119; D32/40, 43; D6/349, 375,
D6/512, 596, 601, 604, 715, 716, 716.1
CPC A63B 21/00047; A63B 21/4039; A63B
2023/006; A63B 2071/0063
See application file for complete search history.

OTHER PUBLICATIONS

Amazon, "Manduka_Yoga Block", Dec. 12, 2014. https://www.amazon.com/Manduka-Recycled-Foam-Block-Thunder/dp/B0084Z3B2C/ref=pd_ybh_a_30?encoding=UTF8&psc=1&refRID=15RW1XRMERZSV5MZWH1R. Shown on p. 1. (Year: 2014).*

(Continued)

Primary Examiner — Cynthia Ramirez
Assistant Examiner — Michael A Maharajh

(56) **References Cited**

U.S. PATENT DOCUMENTS

D222,349 S * 10/1971 Wilhner D6/601
D242,388 S * 11/1976 Castleberry D24/183
D276,938 S * 12/1984 Pedersen 5/636
D291,802 S * 9/1987 Mantell 379/448
D301,063 S * 5/1989 Risi D25/113
D306,245 S * 2/1990 Akhtarekhavari 297/391
D321,562 S * 11/1991 Ljungvall D24/183
D321,760 S * 11/1991 Carney D24/190
D388,650 S * 1/1998 Davis 5/636
D397,270 S * 8/1998 Maalouf 5/636
D403,437 S * 12/1998 Risi D25/113
D411,889 S * 7/1999 Risi D25/108
D423,859 S * 5/2000 Wolff D6/601
D424,698 S * 5/2000 Ames D24/183
D430,308 S * 8/2000 Dawson D25/113
D451,197 S * 11/2001 Jefferson D24/183
6,371,894 B1 * 4/2002 Hill A63B 21/00047
128/845
D457,971 S * 5/2002 Schrader D25/113

(57) **CLAIM**

The ornamental design for a yoga block substantially, as shown and described.

DESCRIPTION

FIG. 1 is a front perspective view of a yoga block in accordance with the present invention;
FIG. 2 is a rear perspective of the yoga block;
FIG. 3 is a front view of the yoga block;
FIG. 4 is a left side view of the yoga block;
FIG. 5 is a rear view of the yoga block;
FIG. 6 is a right side of the yoga block;
FIG. 7 is a top view of the yoga block; and,
FIG. 8 is a bottom view of the yoga block.
Characteristic features of my design reside in part in the four top and bottom corner openings as shown in the drawings.

1 Claim, 4 Drawing Sheets

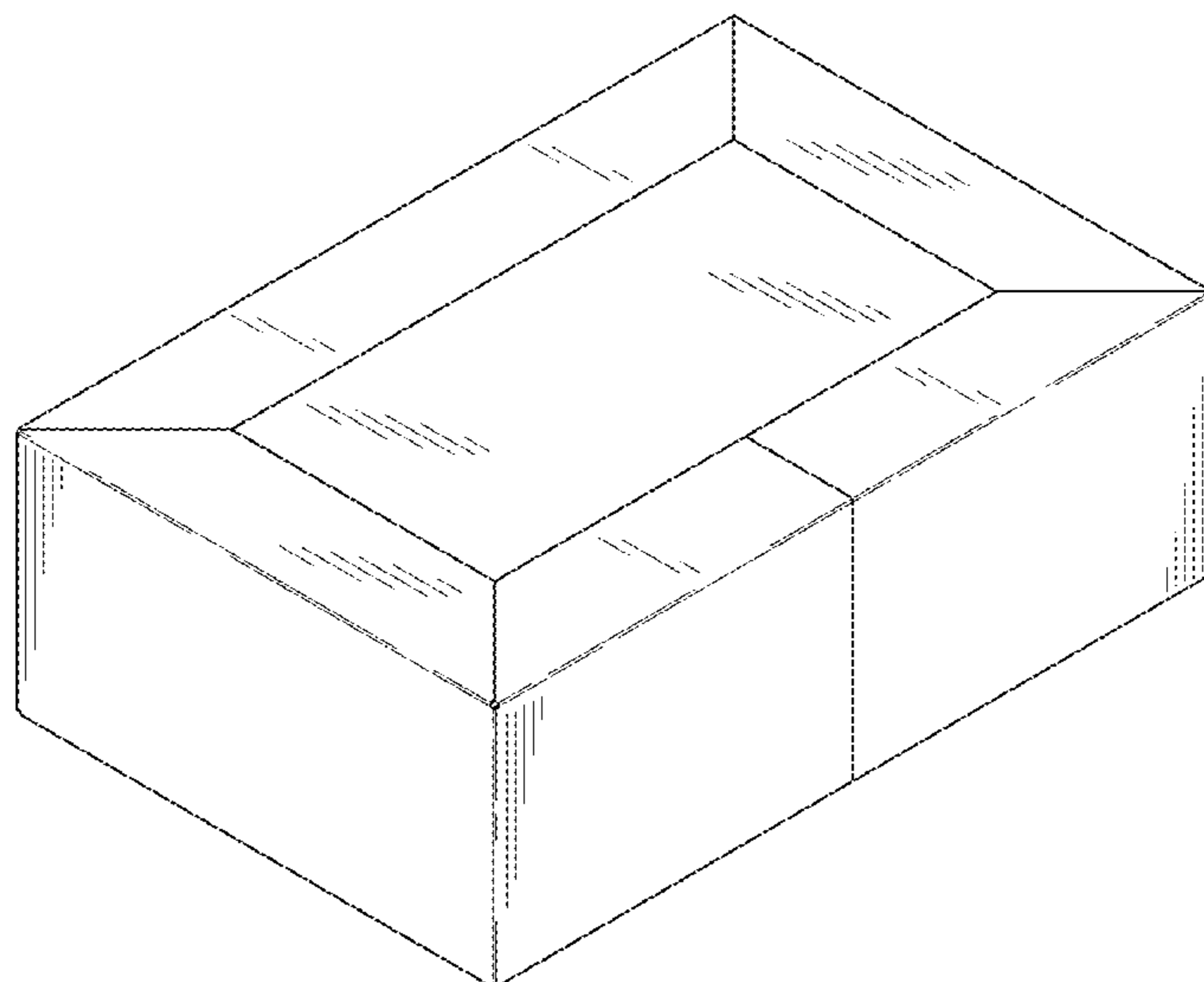

(56)

References Cited

U.S. PATENT DOCUMENTS

D648,444 S * 11/2011 Gauthier D25/113
 D664,256 S * 7/2012 Dennewald D24/183
 D665,503 S * 8/2012 Dennewald D24/183
 D691,222 S * 10/2013 Sterios D21/686
 D695,857 S * 12/2013 Sterios D21/686
 D701,582 S * 3/2014 Sterios D21/686
 D707,312 S * 6/2014 Sterios D21/686
 D708,765 S * 7/2014 MacDonald D25/113
 D728,799 S * 5/2015 Ravikumar D24/184
 D733,230 S * 6/2015 Mallory D21/686
 D739,036 S * 9/2015 McAviney D24/211
 D740,378 S * 10/2015 Walsh-Gomez D21/662
 D747,899 S * 1/2016 Klein D6/601
 D764,062 S * 8/2016 Dennewald A47G 9/1081
 D779,601 S * 2/2017 Scholder A63B 21/4039
 D781,429 S * 3/2017 Westdyk D24/190
 D815,700 S * 4/2018 Brodwick D21/686
 D816,855 S * 5/2018 Neseem D24/190
 D823,404 S * 7/2018 Razon D21/688
 D837,313 S * 1/2019 Lyons D21/686
 D842,617 S * 3/2019 Carter D6/349
 D855,217 S * 7/2019 Mugge D25/113
 D859,664 S * 9/2019 Dennewald D24/183
 D863,825 S * 10/2019 Xu D6/601
 D866,208 S * 11/2019 Chan D6/349
 D866,799 S * 11/2019 Riccobene D25/113

D871,593 S * 12/2019 Rossouw D24/190
 D875,193 S * 2/2020 Sz nyi D21/686
 D880,628 S * 4/2020 McHenry D21/686
 D887,505 S * 6/2020 Tumpson D21/686
 D893,760 S * 8/2020 Bott D25/113
 2004/0031230 A1 * 2/2004 Pabedinskas E04C 3/28
 2010/0240509 A1 * 9/2010 Chen A63B 21/00047
 2011/0207587 A1 * 8/2011 De La Rambelje
 A63B 21/4039
 2014/0087930 A1 * 3/2014 Burns A63B 71/0036
 2014/0274589 A1 * 9/2014 Harkins A63B 21/00047
 2014/0318550 A1 * 10/2014 Doci A63B 23/0494
 2018/0214733 A1 * 8/2018 DeNunzio A63B 21/4039
 2018/0256940 A1 * 9/2018 Lyons A63B 26/003
 2018/0311526 A1 * 11/2018 Eddy A63B 21/154

OTHER PUBLICATIONS

Amazon, "Bean products_Yoga Blocks" May 13, 2012. https://www.amazon.com/Bean-Products-Yoga-Blocks-Standard/dp/B0081X4YUK/ref=cm_cr_arp_d_product_top?ie=UTF8. Shown on p. 1. (Year: 2012).*

* cited by examiner

FIG. 1

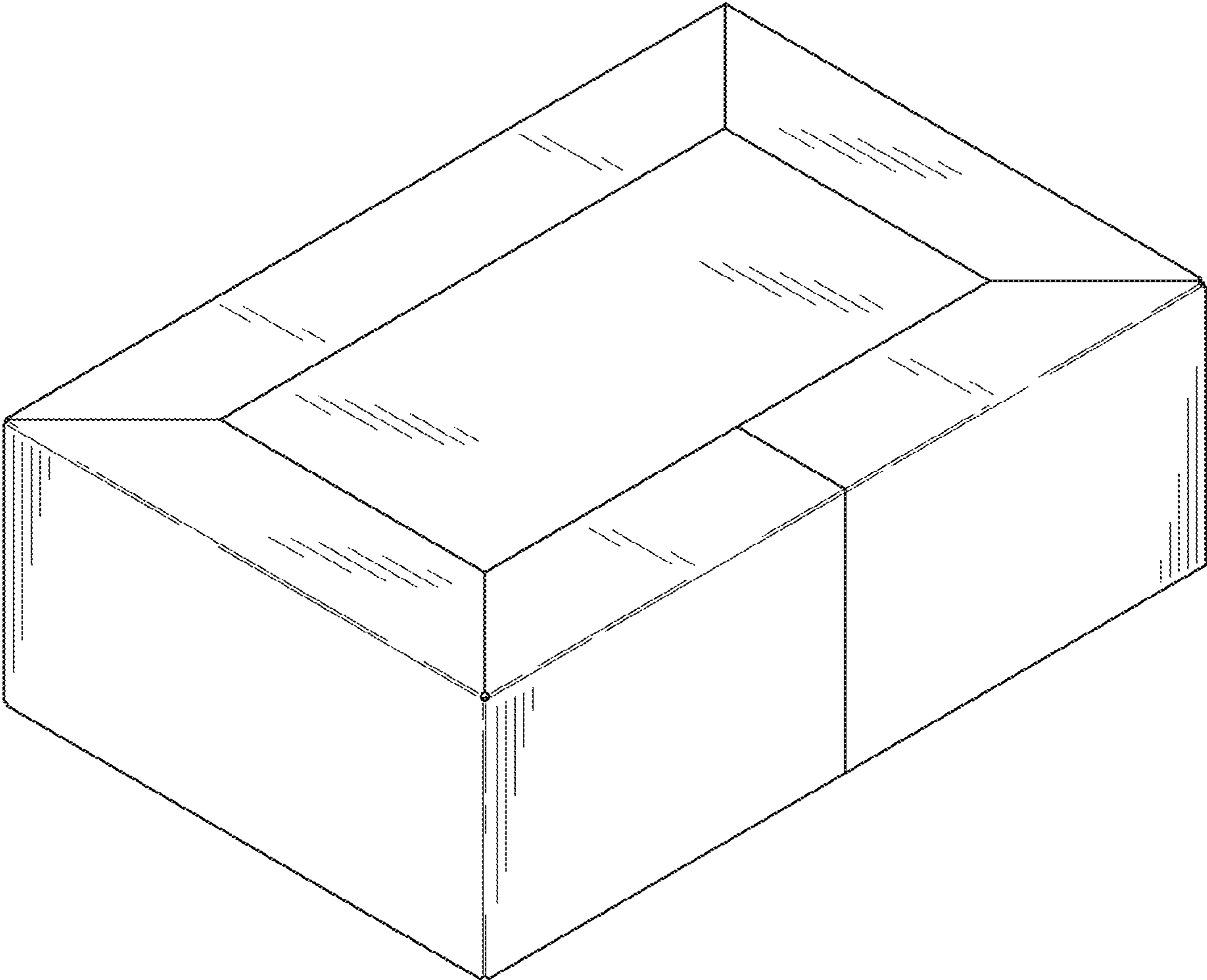

FIG. 2

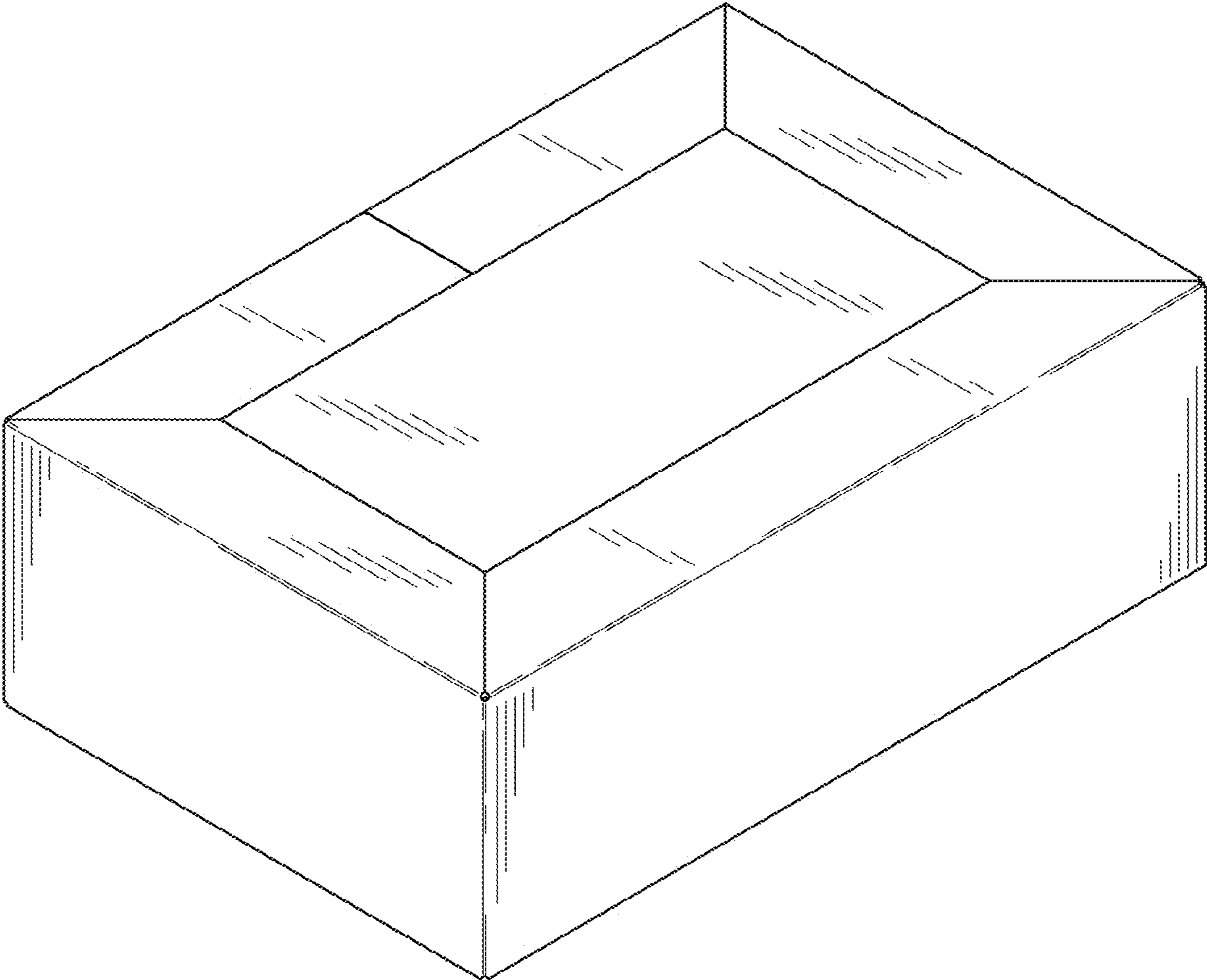

FIG. 3

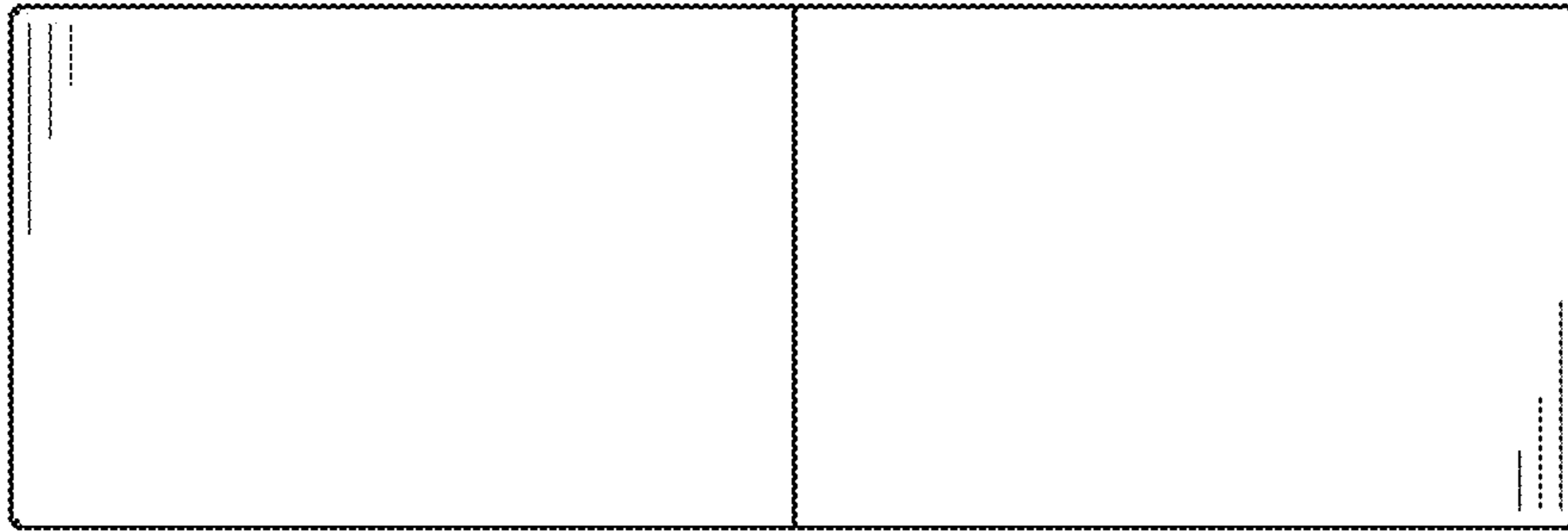

FIG. 4

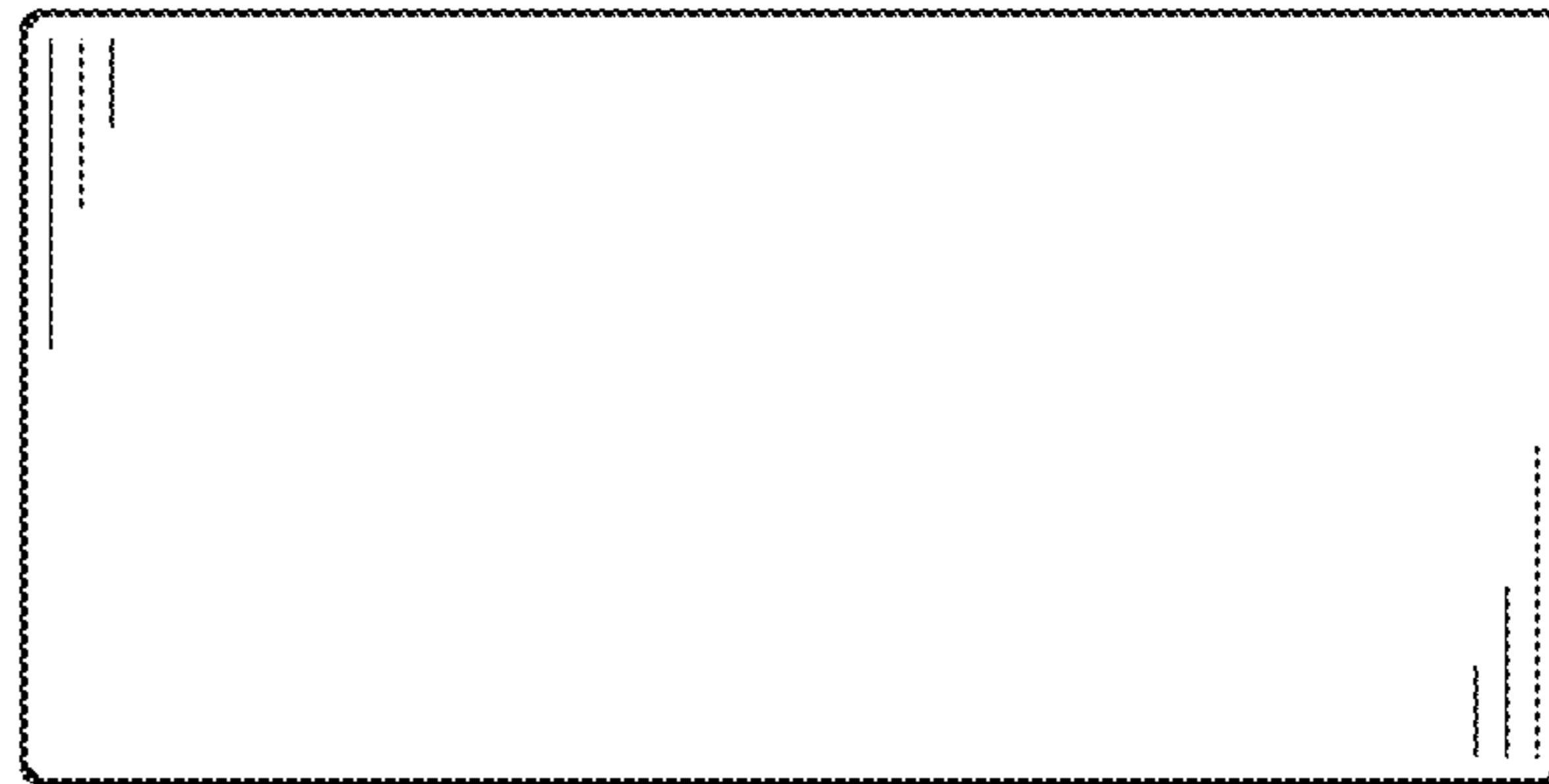

FIG. 5

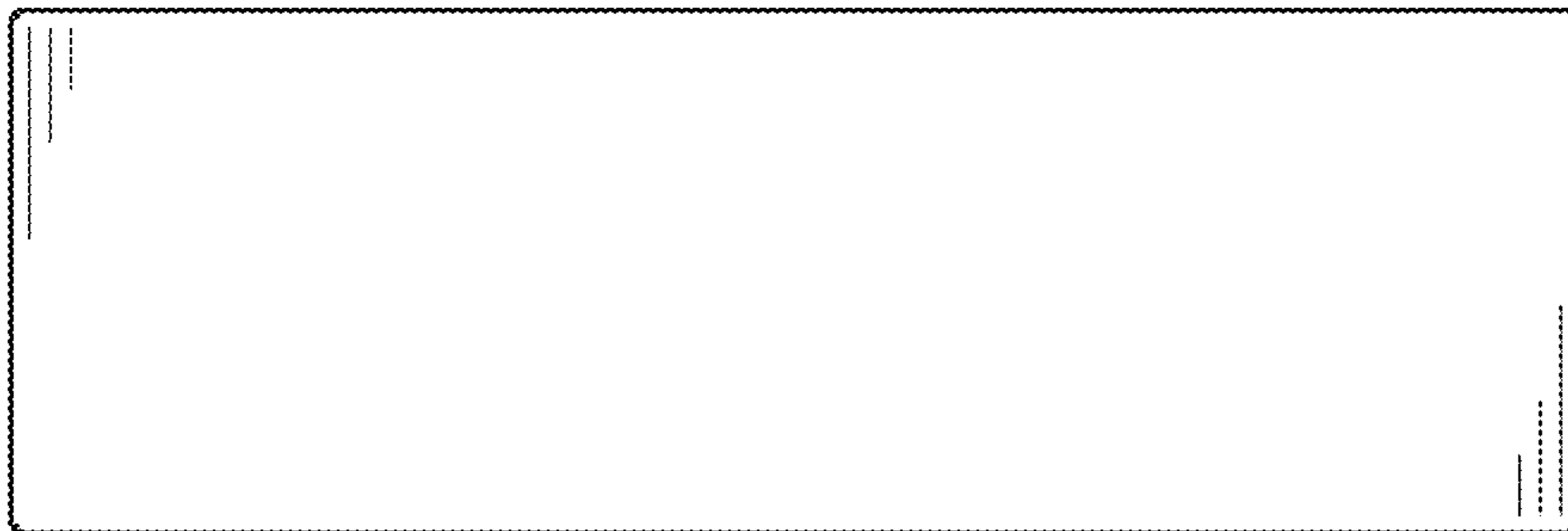

FIG. 6

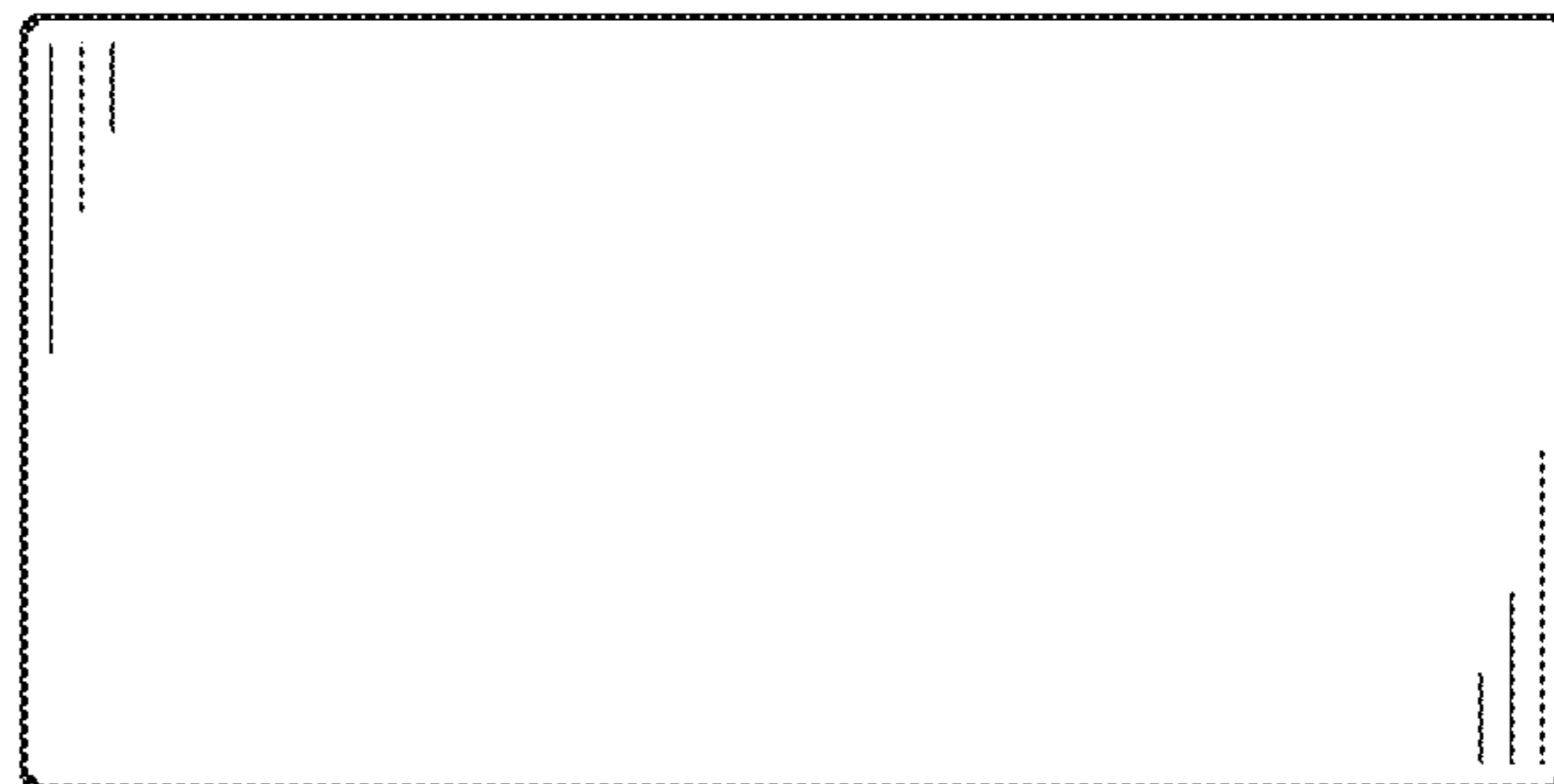

FIG. 7

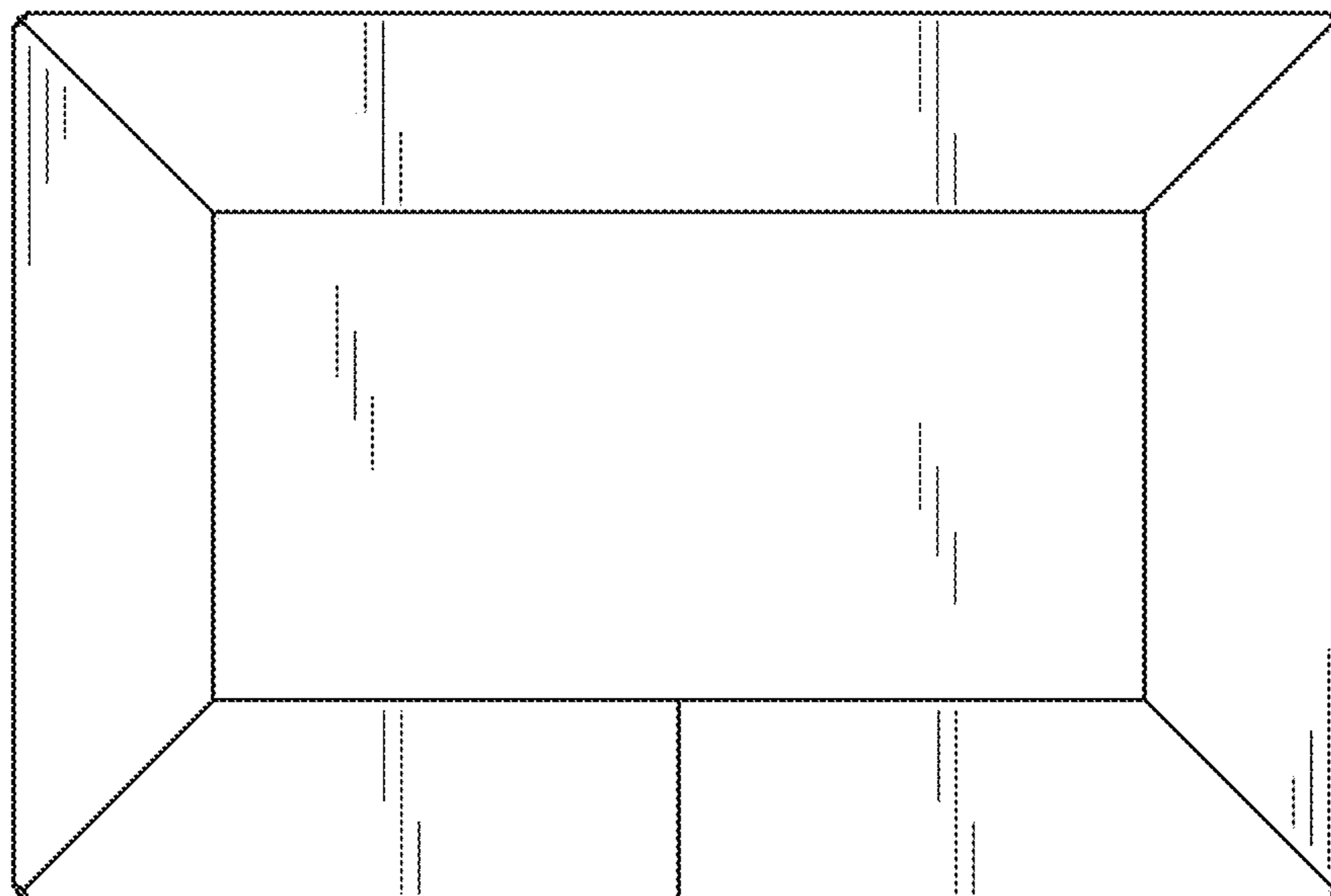

FIG. 8

