



US00D928782S

(12) **United States Design Patent**  
**Seo et al.**

(10) **Patent No.:** **US D928,782 S**  
(45) **Date of Patent:** **\*\* Aug. 24, 2021**

(54) **VISUAL DISPLAY UNIT HAVING ROLLABLE DISPLAY**

FOREIGN PATENT DOCUMENTS

(71) Applicant: **LG DISPLAY CO., LTD.**, Seoul (KR)

JP D1544715 \* 2/2019

(72) Inventors: **Dong-Jin Seo**, Paju-si (KR); **Soomin Ryou**, Paju-si (KR); **KiHwan Son**, Paju-si (KR); **Il-sup Yoon**, Paju-si (KR)

OTHER PUBLICATIONS

LG patents a new smartphone design, Sep. 11, 2019 [online], [retrieved Dec. 2, 2020], Retrieved from Internet, URL: <https://www.gizmochina.com/2019/09/11/lg-rollable-display-patent/> (Year: 2019).\*

(73) Assignee: **LG Display Co., Ltd.**, Seoul (KR)

(\*\*) Term: **15 Years**

(Continued)

(21) Appl. No.: **29/688,128**

*Primary Examiner* — Barbara Fox  
*Assistant Examiner* — Aram Kwon

(22) Filed: **Apr. 18, 2019**

(74) *Attorney, Agent, or Firm* — Birch, Stewart, Kolasch & Birch, LLP

(30) **Foreign Application Priority Data**

Oct. 19, 2018 (KR) ..... 30-2018-0048132

(51) **LOC (13) Cl.** ..... **14-02**

(57) **CLAIM**

(52) **U.S. Cl.**  
USPC ..... **D14/345**; D14/341

The ornamental design for a visual display unit having rollable display, as shown and described.

(58) **Field of Classification Search**

**DESCRIPTION**

USPC ..... D14/129–130, 137, 138 AA, 138 AB, D14/138 AC, 138 AD, 138 C, 138 G, D14/138 R, 147, 203.3–203.8, 218, 240, D14/247, 248, 315–318, 341–347, 371, D14/374, 388–389, 420, 426, 496; D6/308, 310; D10/50, 65, 104.1; D18/6–7; D19/26, 59–60; D21/324, D21/329–330, 332  
CPC .... G06F 1/1613; G06F 1/1626; G06F 3/0488; G06F 3/04886; H04M 1/725; H04M 1/0202; H04M 1/0266  
See application file for complete search history.

FIG. 1 is a front, right perspective view of the visual display unit having rollable display showing our new design;  
FIG. 2 is a front view thereof;  
FIG. 3 is a rear view thereof;  
FIG. 4 is a left side view thereof;  
FIG. 5 is a right side view thereof;  
FIG. 6 is a top plan view thereof;  
FIG. 7 is a bottom plan view thereof;  
FIG. 8 is a front, right perspective view of the visual display unit having rollable display in an unrolled position;  
FIG. 9 is a front view thereof;  
FIG. 10 is a rear view thereof;  
FIG. 11 is a left side view thereof;  
FIG. 12 is a right side view thereof;  
FIG. 13 is a top plan view thereof; and,  
FIG. 14 is a bottom plan view thereof.

(56) **References Cited**

U.S. PATENT DOCUMENTS

4,374,906 A \* 2/1983 Breault ..... H01M 8/0271  
429/498  
D597,090 S \* 7/2009 Bemelmans ..... D14/341

(Continued)

**1 Claim, 14 Drawing Sheets**

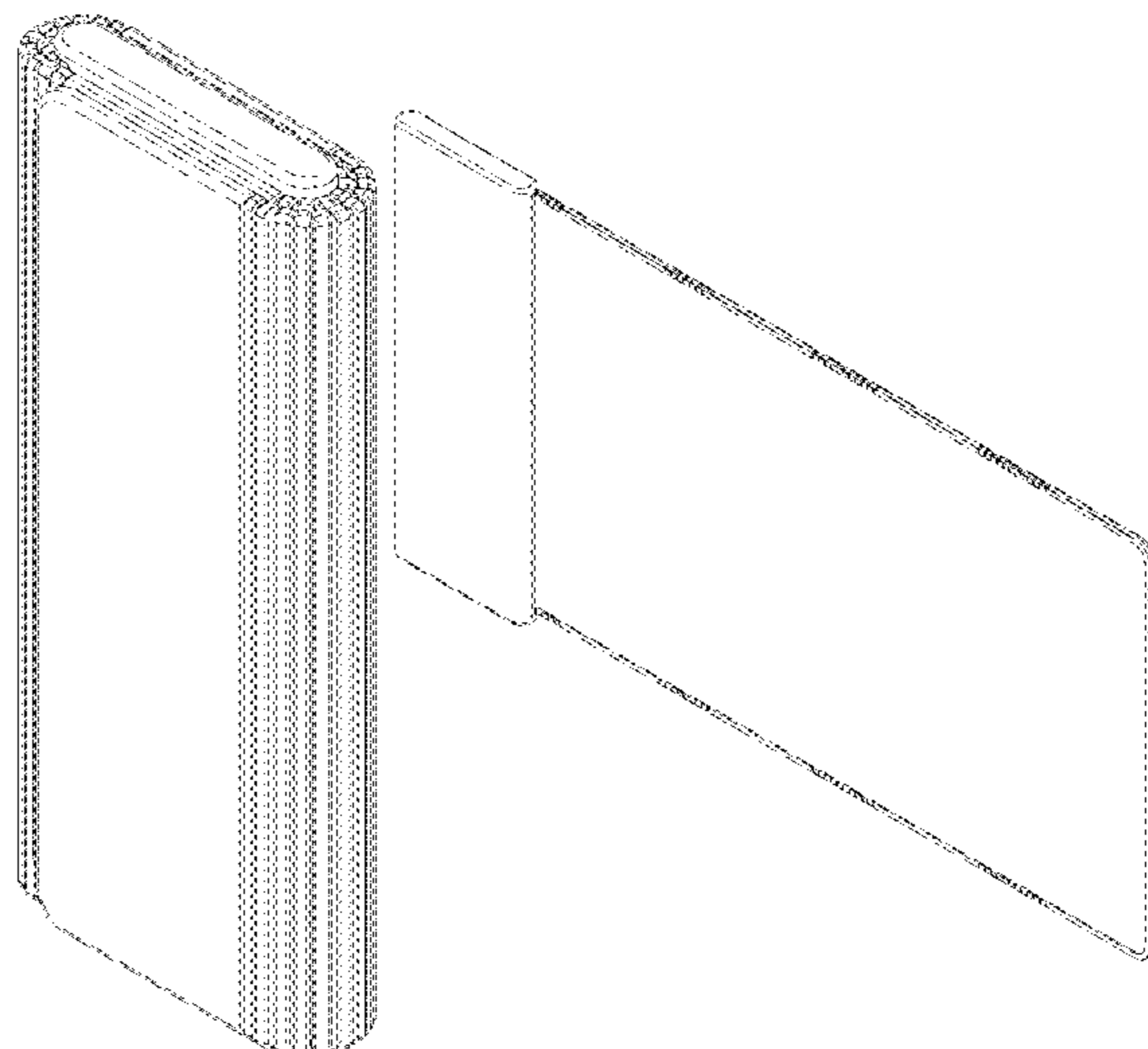

(56)

**References Cited**

U.S. PATENT DOCUMENTS

8,773,411 B2 \* 7/2014 van Lieshout ..... G06F 1/1652  
 345/204  
 8,873,225 B2 \* 10/2014 Huitema ..... G06F 1/1656  
 361/679.01  
 D733,960 S \* 7/2015 Howe ..... D26/122  
 D761,251 S \* 7/2016 Senda ..... D14/341  
 D761,252 S \* 7/2016 Senda ..... D14/341  
 D761,253 S \* 7/2016 Yamazaki ..... D14/341  
 D761,788 S \* 7/2016 Yamazaki ..... D14/341  
 D770,447 S \* 11/2016 Endo ..... D14/371  
 D789,925 S \* 6/2017 Browning ..... D14/341  
 D822,633 S \* 7/2018 Yeom ..... D14/138 AB  
 D901,422 S \* 11/2020 Lee ..... D14/138 AB  
 D911,299 S \* 2/2021 Kim ..... D14/126  
 D913,282 S \* 3/2021 Song ..... D14/345  
 D920,272 S \* 5/2021 Lee, II ..... D14/138 AB  
 D920,973 S \* 6/2021 Lee ..... D14/345

D922,343 S \* 6/2021 Bae ..... D14/138 AB  
 D922,344 S \* 6/2021 Lee ..... D14/138 R  
 2008/0204367 A1 \* 8/2008 Lafarre ..... G09F 9/301  
 345/55  
 2016/0246558 A1 \* 8/2016 Prushinskiy ..... G06F 1/3218  
 2017/0003756 A1 \* 1/2017 Gao ..... G06F 3/0304  
 2017/0061836 A1 \* 3/2017 Kim ..... G06F 1/1652

OTHER PUBLICATIONS

LG's rollable display smartphone, Jul. 2, 2020 [online], [retrieved Dec. 2, 2020], Retrieved from Internet, URL: <<https://www.gizmochina.com/2020/07/02/lg-rollable-display-smartphone-project-b-launch-next-year/>> (Year: 2020).\*

Rollable Phones: LG's new rollable phone, Sep. 10, 2019 [online], [retrieved Dec. 2, 2020], Retrieved from Internet, URL: <<https://www.phonefoldable.com/rollable-phones-lgs-new-rollable-phone-will-be-perfect-for-mobile-gaming-and-streaming/>> (Year: 2019).\*

\* cited by examiner

FIG. 1

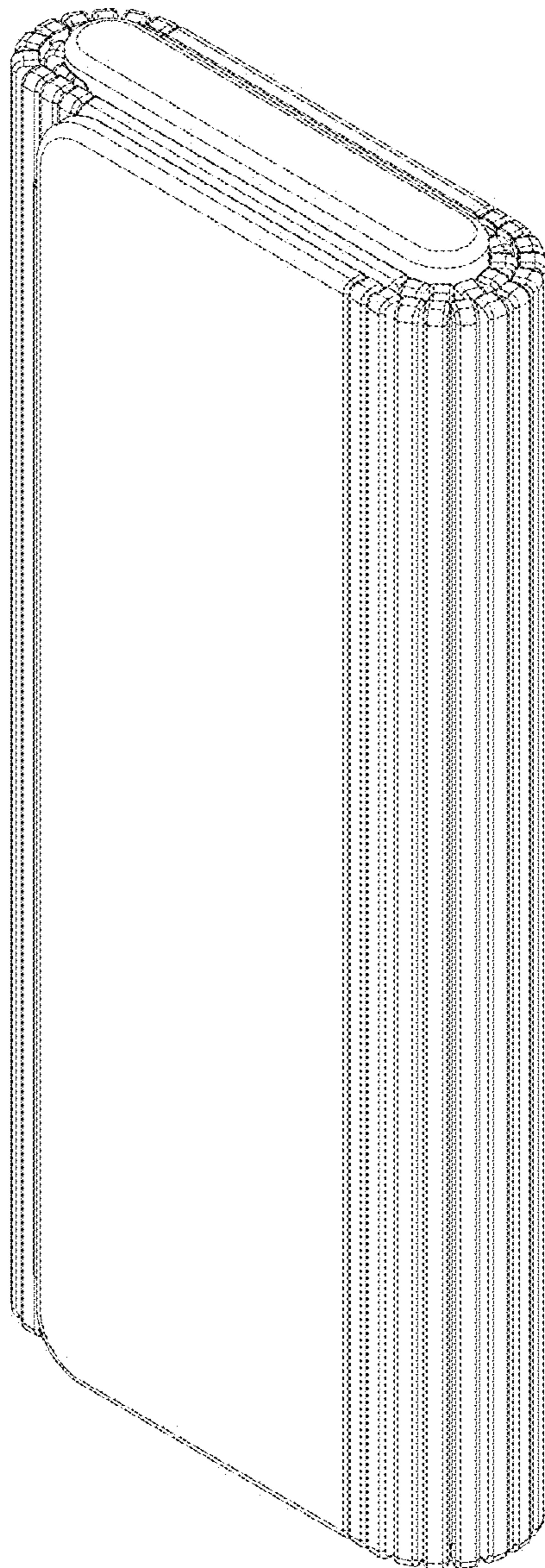

FIG. 2

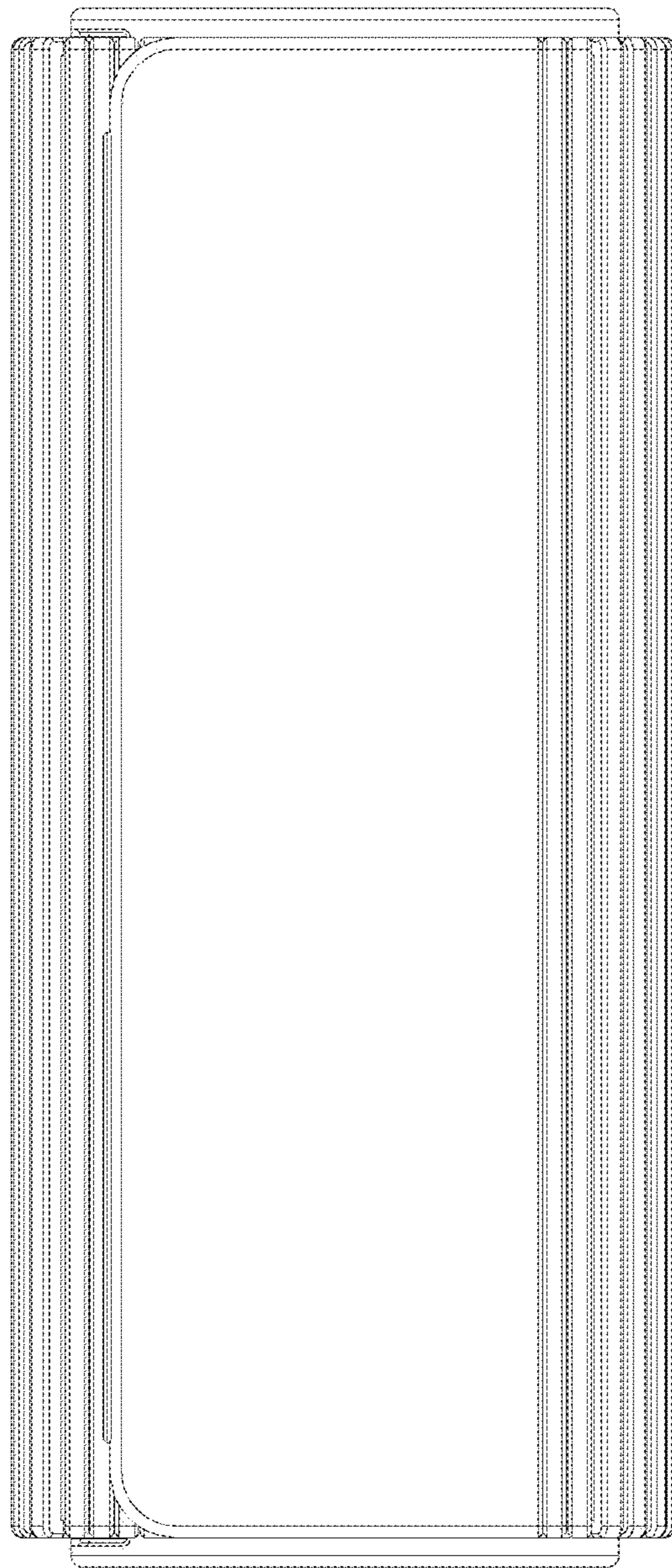

FIG. 3

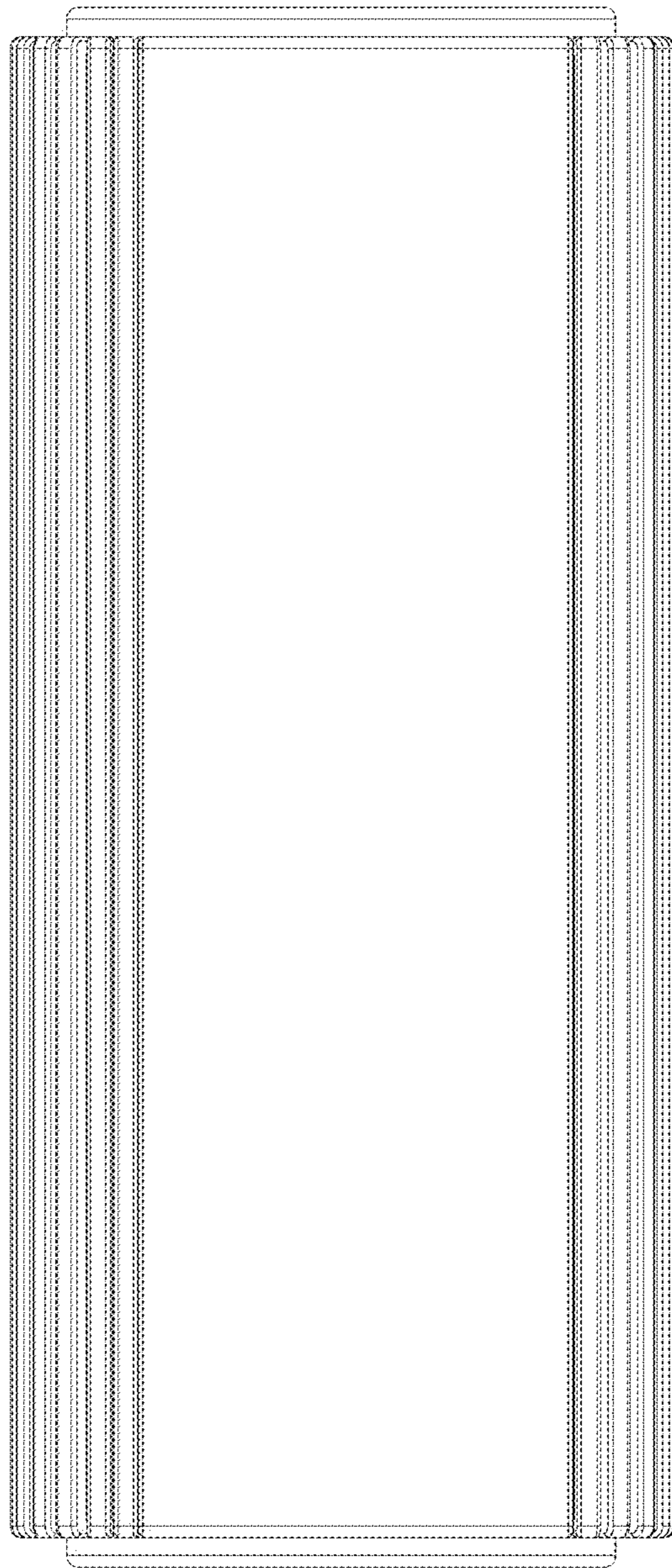

FIG. 4

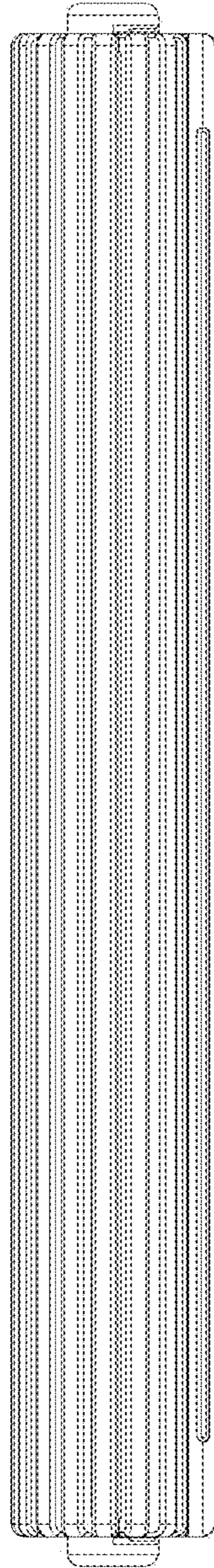

FIG. 5

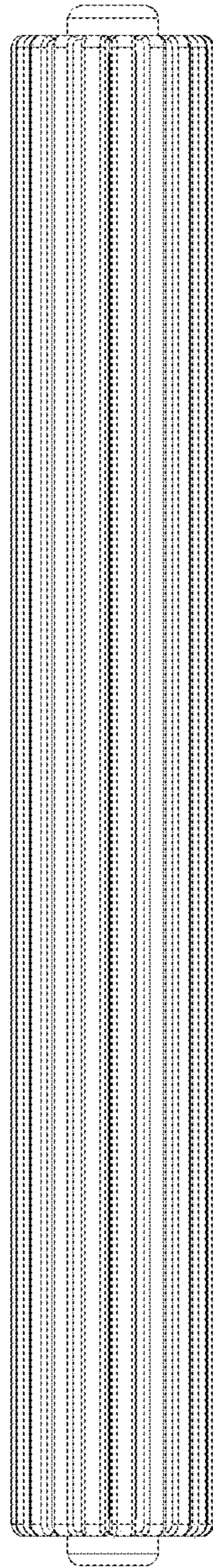

FIG. 6

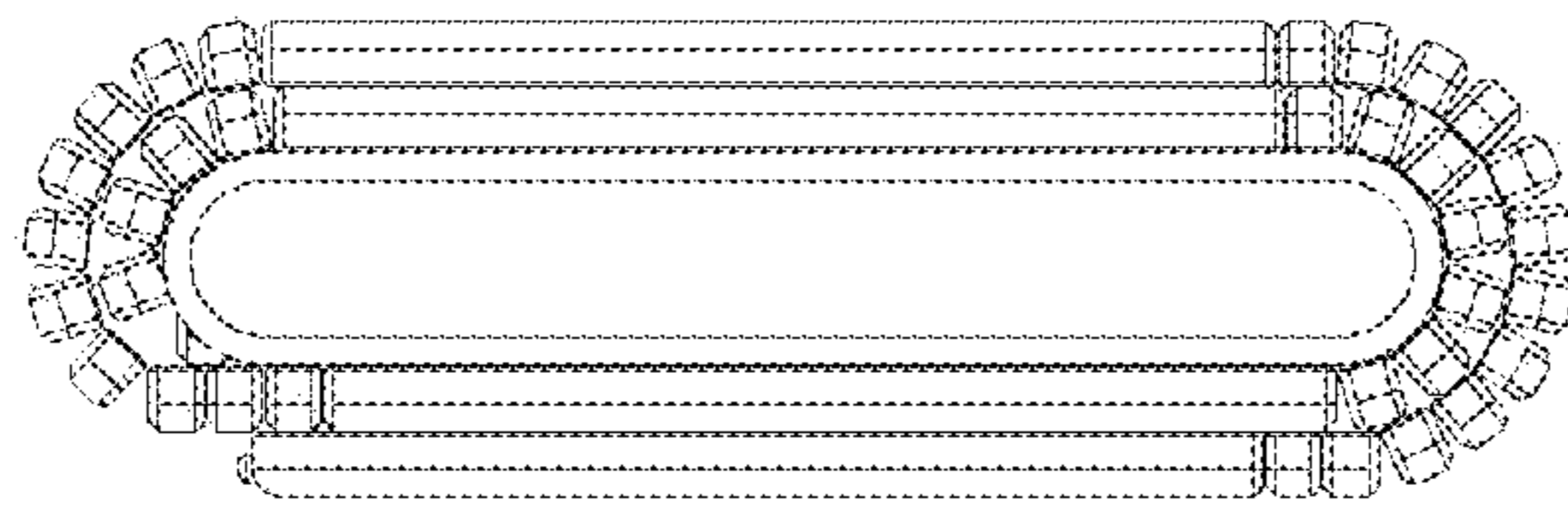



FIG. 7

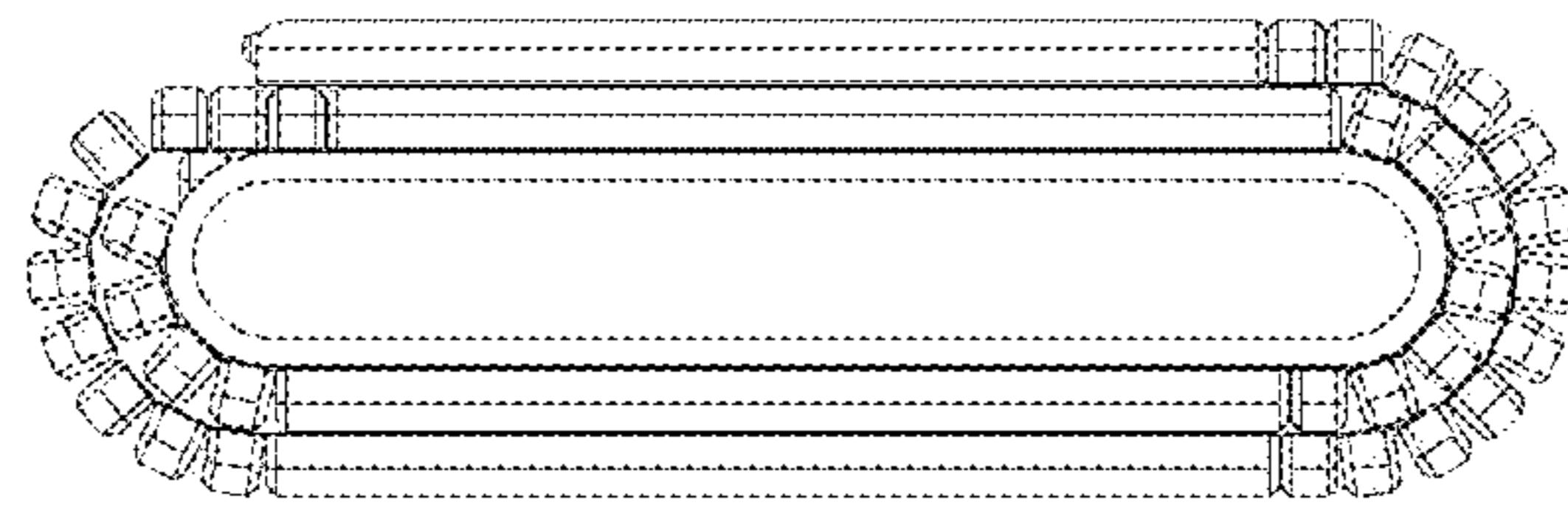

FIG. 8

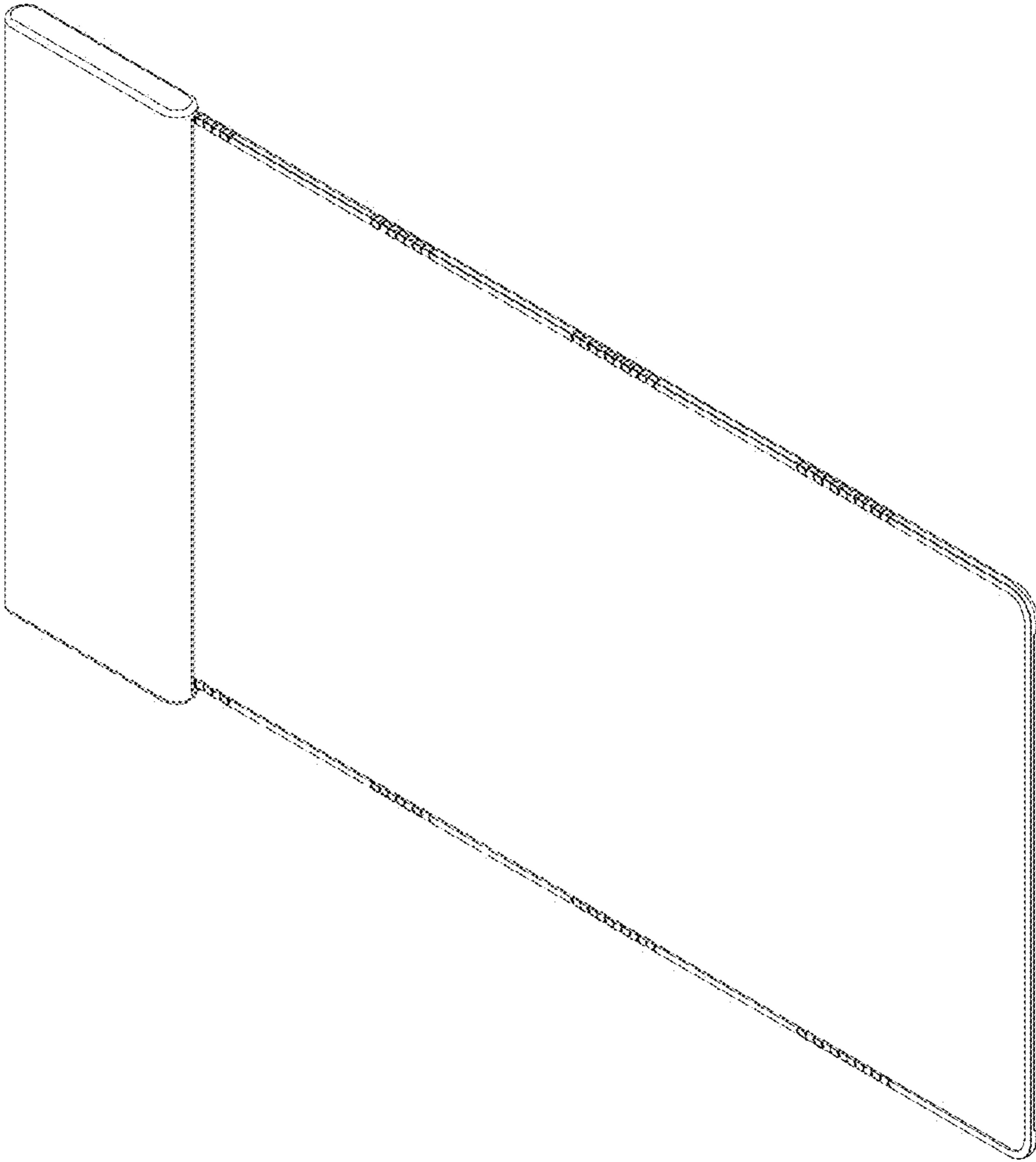

FIG. 9

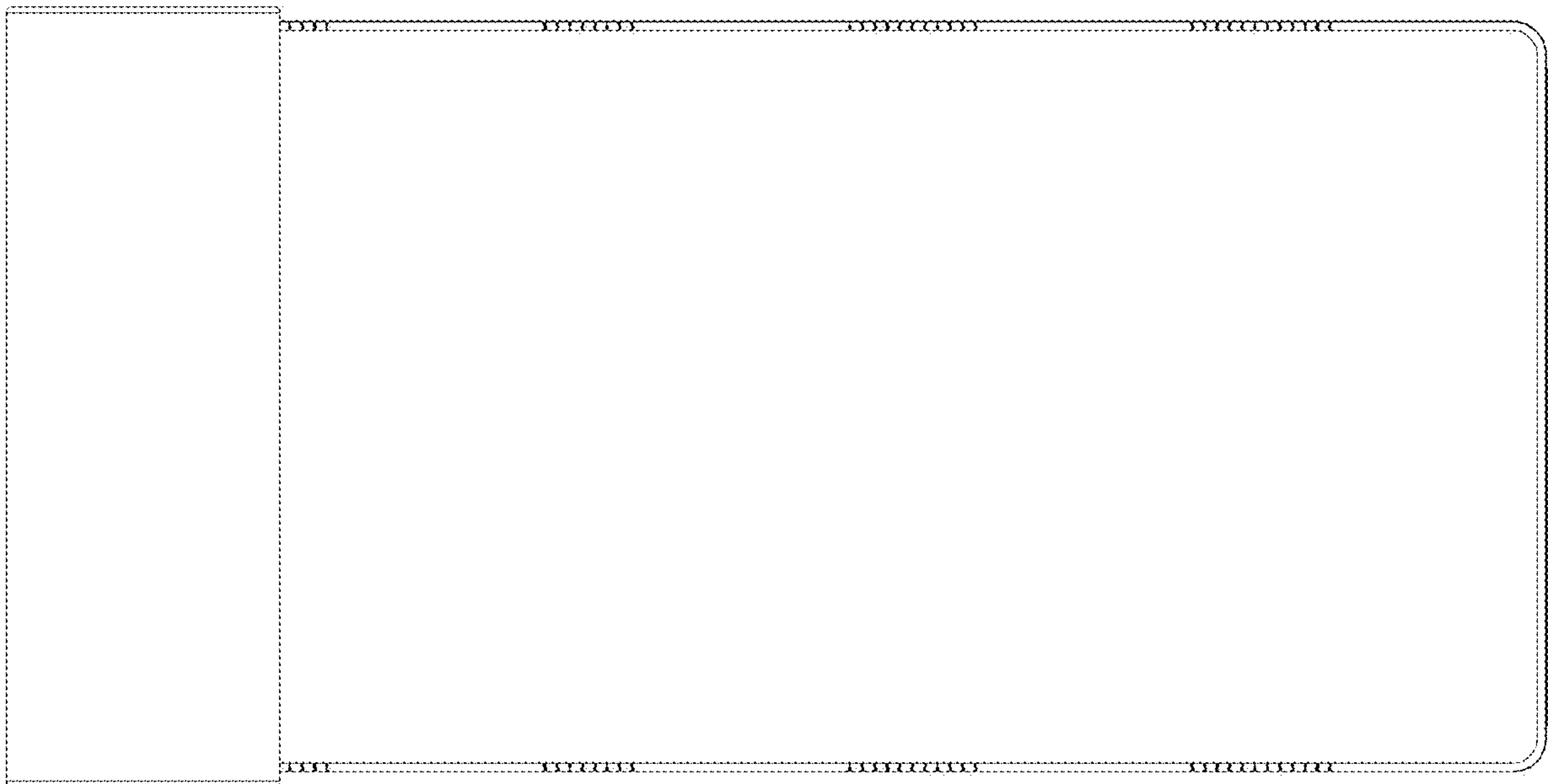

FIG. 10

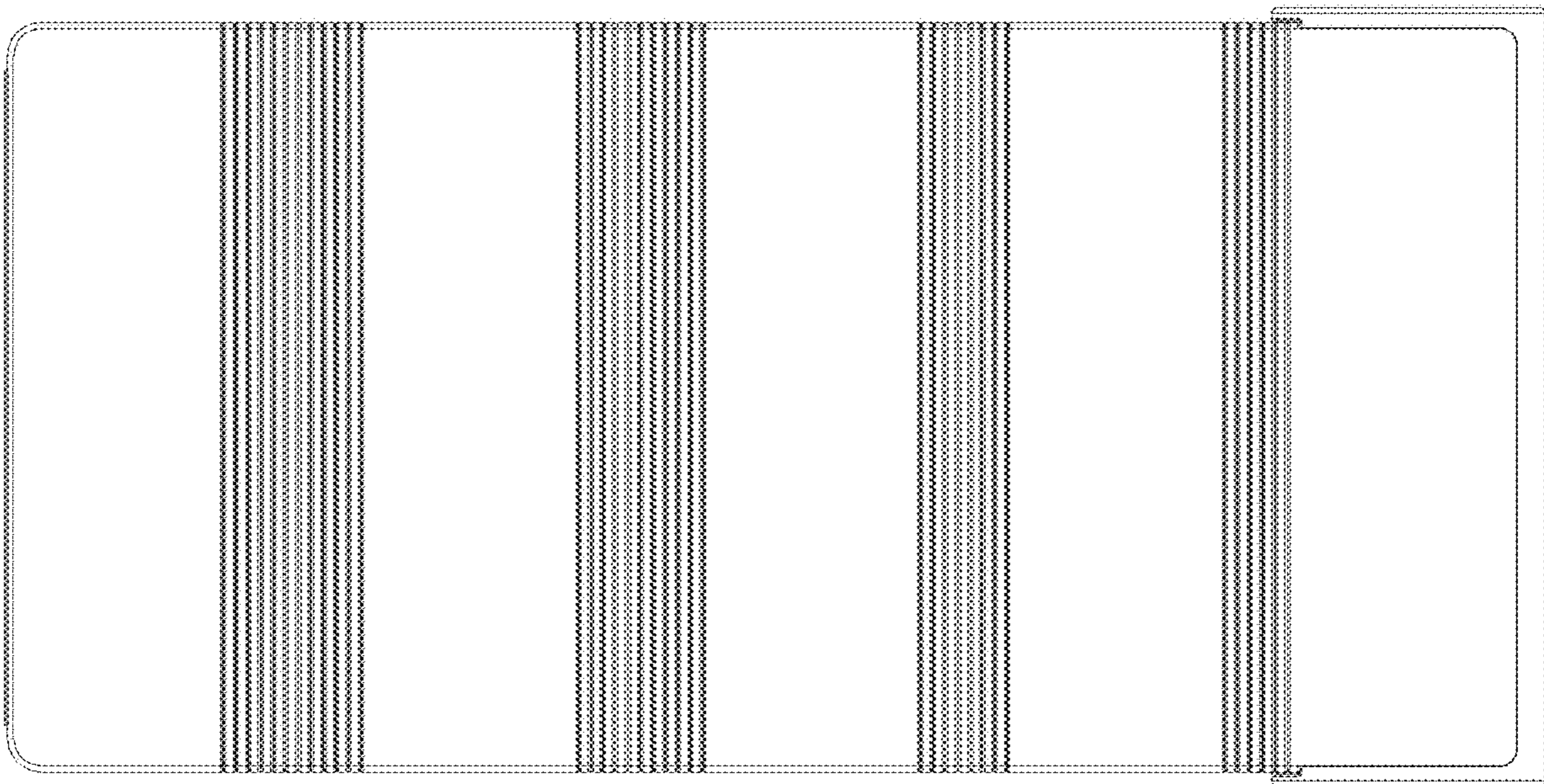

FIG. 11

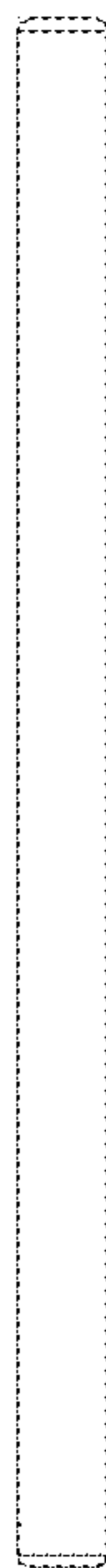

FIG. 12

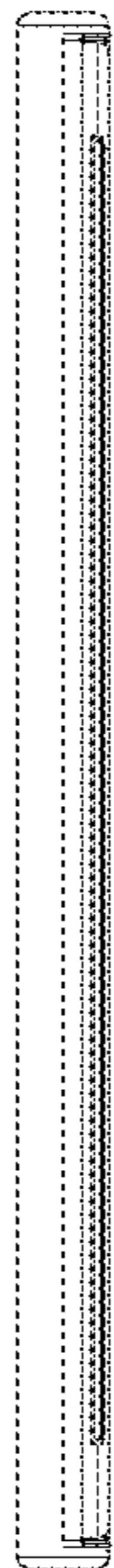

FIG. 13

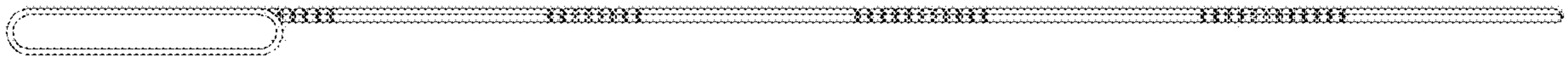

FIG. 14

