



US00D928667S

(12) **United States Design Patent** (10) **Patent No.:** **US D928,667 S**  
**Zhu** (45) **Date of Patent:** **\*\* Aug. 24, 2021**

(54) **SCOOTER**

(71) Applicant: **Zhanyu Zhu**, Changzhou (CN)

(72) Inventor: **Zhanyu Zhu**, Changzhou (CN)

(\*\*) Term: **15 Years**

(21) Appl. No.: **29/722,073**

(22) Filed: **Jan. 26, 2020**

(51) **LOC (13) Cl.** ..... **12-11**

(52) **U.S. Cl.**

USPC ..... **D12/111; D21/423**

(58) **Field of Classification Search**

USPC ..... D12/1, 8, 107, 110-114; D21/419, 421,  
D21/423, 760, 765, 771

CPC ..... B62K 3/002; B62K 9/00; B62K 2202/00;  
B60Y 2200/126

See application file for complete search history.

(56) **References Cited**

**U.S. PATENT DOCUMENTS**

6,450,516 B1 *	9/2002	Nall, III	.....	B62K 3/002 280/288.1
D755,899 S *	5/2016	Castrucci	.....	D21/423
D774,961 S *	12/2016	Allen	.....	D12/110
D778,806 S *	2/2017	Welford	.....	D12/423
D803,948 S *	11/2017	Chis	.....	D21/423
D814,978 S *	4/2018	Niu	.....	D12/110
D830,911 S *	10/2018	Li	.....	D12/110
D832,931 S *	11/2018	Gudushauri	.....	D21/423
D866,674 S *	11/2019	Li	.....	D21/423
D914,107 S *	3/2021	Van Houten	.....	D21/423
D919,482 S *	5/2021	Lin	.....	D12/110

**OTHER PUBLICATIONS**

“CliX” KickBike., posted date Sep. 13, 2016 [online], [retrieved on Jun. 17, 2021]. Retrieved from the Internet <[https://kickbike.com/showroom\\_en/kickbike/product-clix.html](https://kickbike.com/showroom_en/kickbike/product-clix.html)> (Year: 2016).\*

“The Atom Sidewalker Collapsible Adult Scooter” SideWalkerUSA., posted date Mar. 27, 2014 [online], [retrieved on Jun. 17, 2021]. Retrieved from the Internet <<https://www.sidewalkerusa.com/atom.html>> (Year: 2014).\*

“Mongoose Trace Youth/Adult Kick Scooter” Mongoose., posted date Jun. 24, 2020 [online], [retrieved on Jun. 17, 2021]. Retrieved from the Internet <<https://tinyurl.com/455yxf3x>> (Year: 2020).\*

\* cited by examiner

*Primary Examiner* — Darlington Ly

*Assistant Examiner* — Nasim Abdulaziz Ali

(74) *Attorney, Agent, or Firm* — Feng Qian

(57) **CLAIM**

The ornamental design for an scooter, as shown and described.

**DESCRIPTION**

FIG. 1 is a front perspective view of a scooter embodying my new design;

FIG. 2 is a left side elevation view thereof;

FIG. 3 is a right side elevation view thereof;

FIG. 4 is a front elevation view thereof;

FIG. 5 is a rear elevation view thereof; and,

FIG. 6 is a top plan view thereof.

The broken lines in the drawings illustrate portions of the scooter that form no part of the claimed design.

**1 Claim, 6 Drawing Sheets**

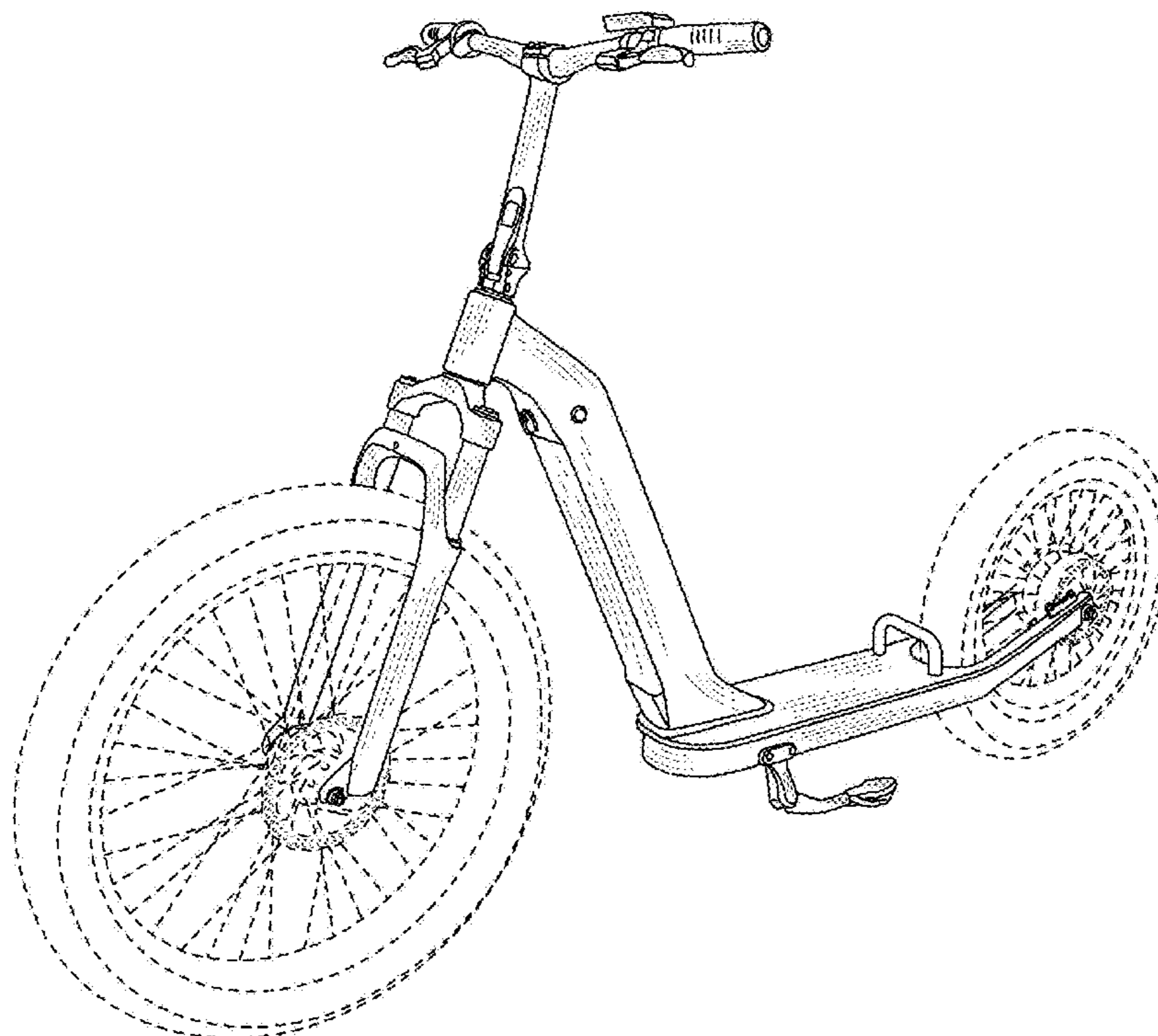

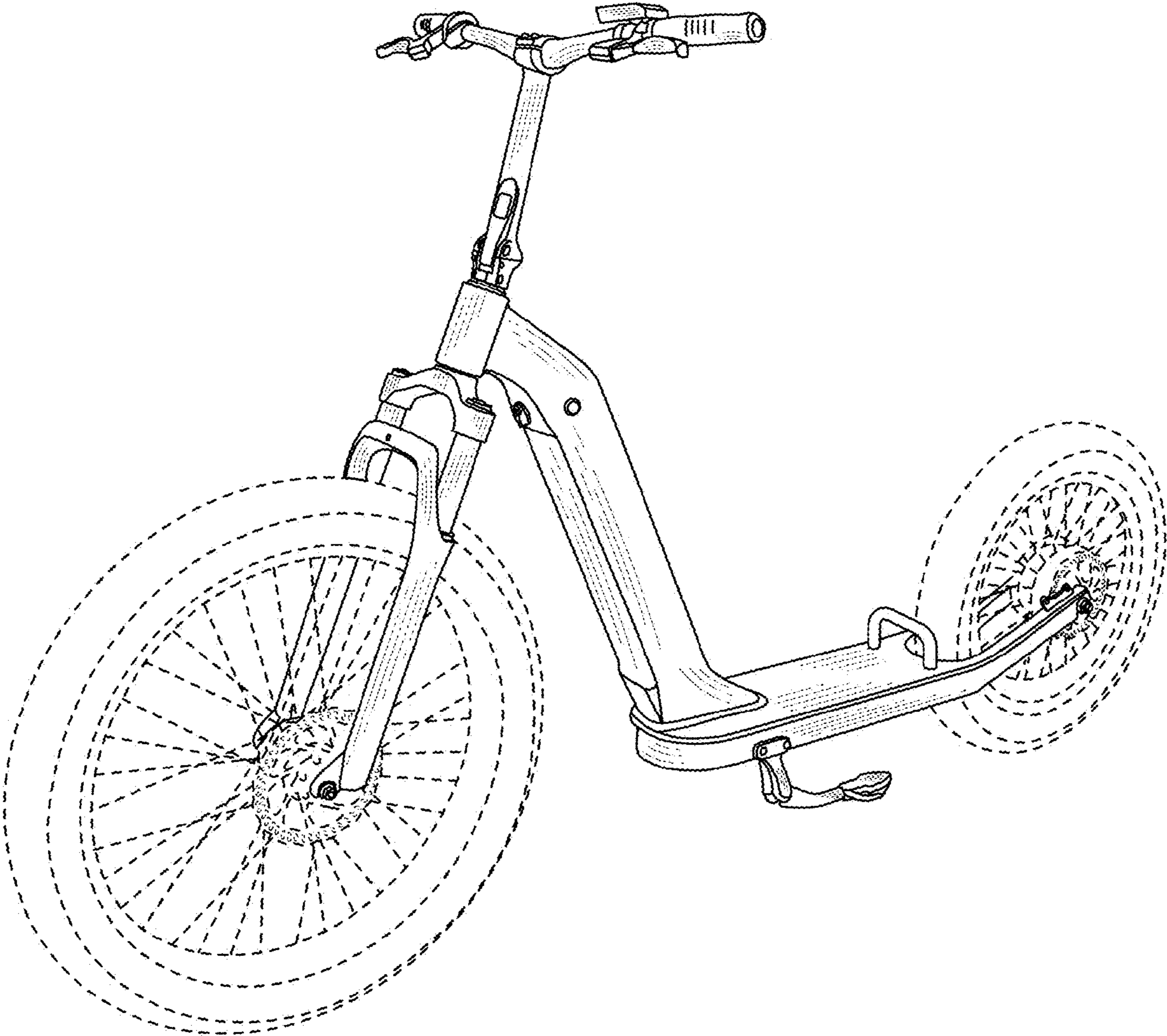

FIG. 1

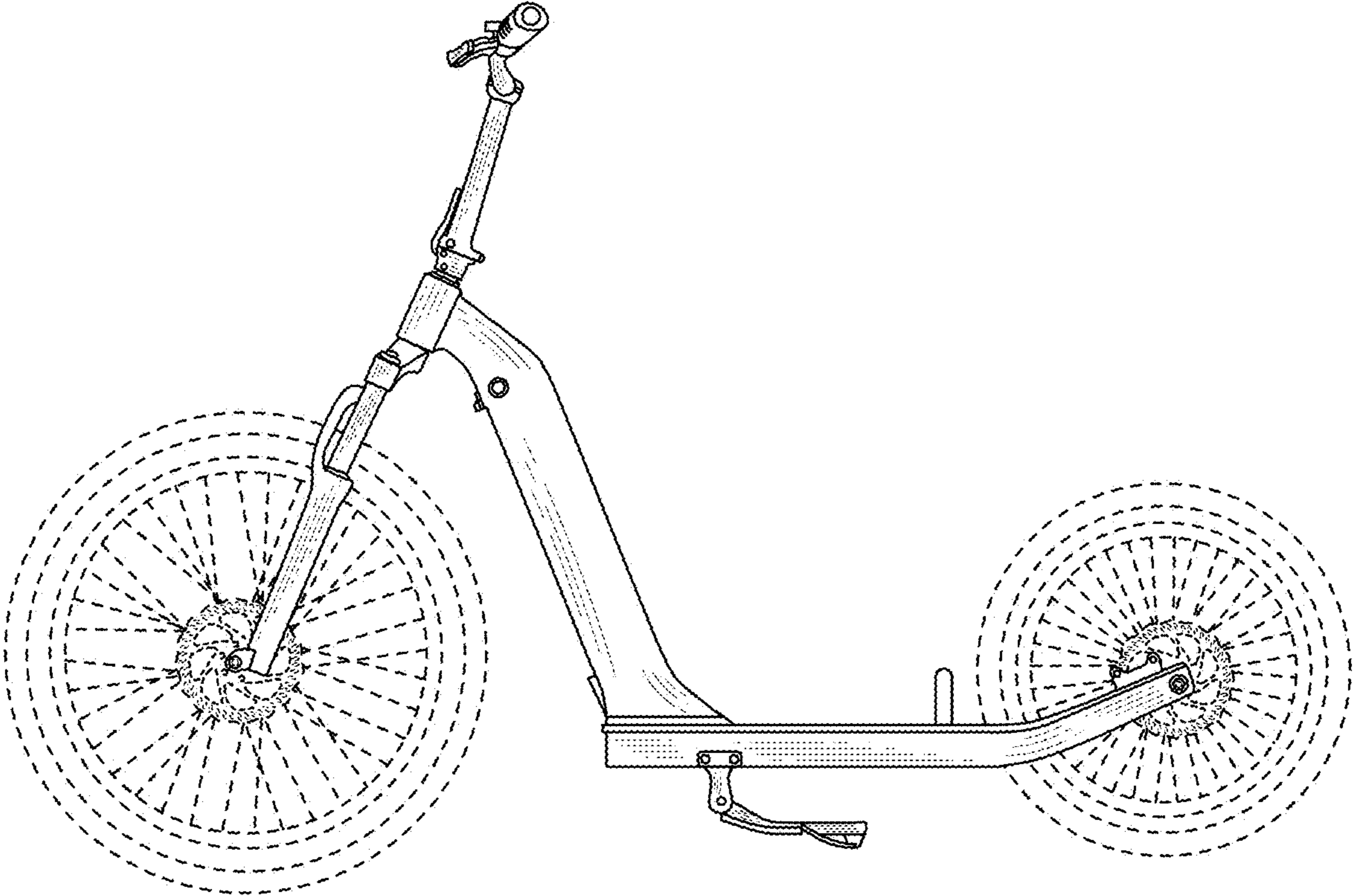

FIG. 2

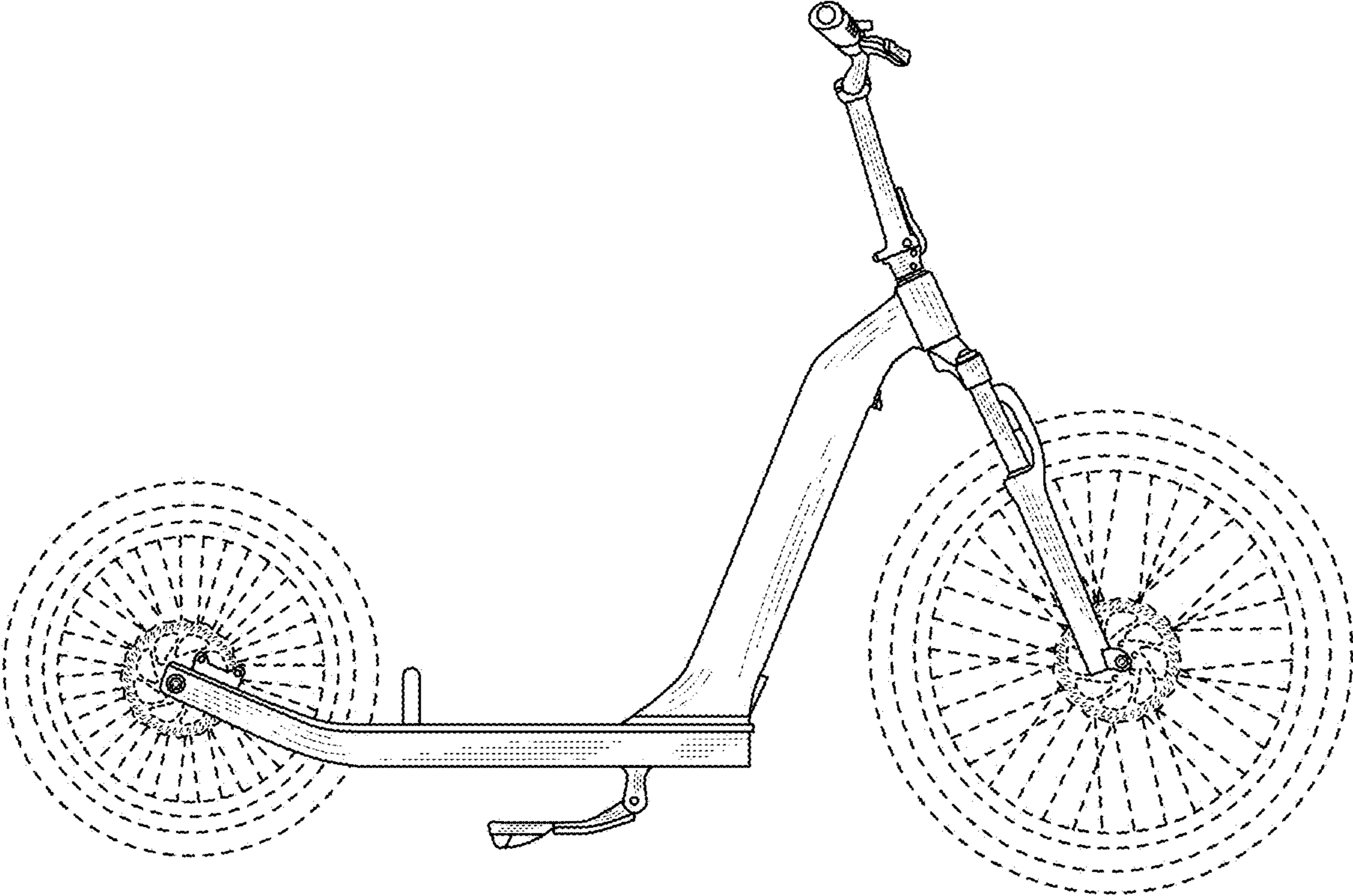

FIG. 3

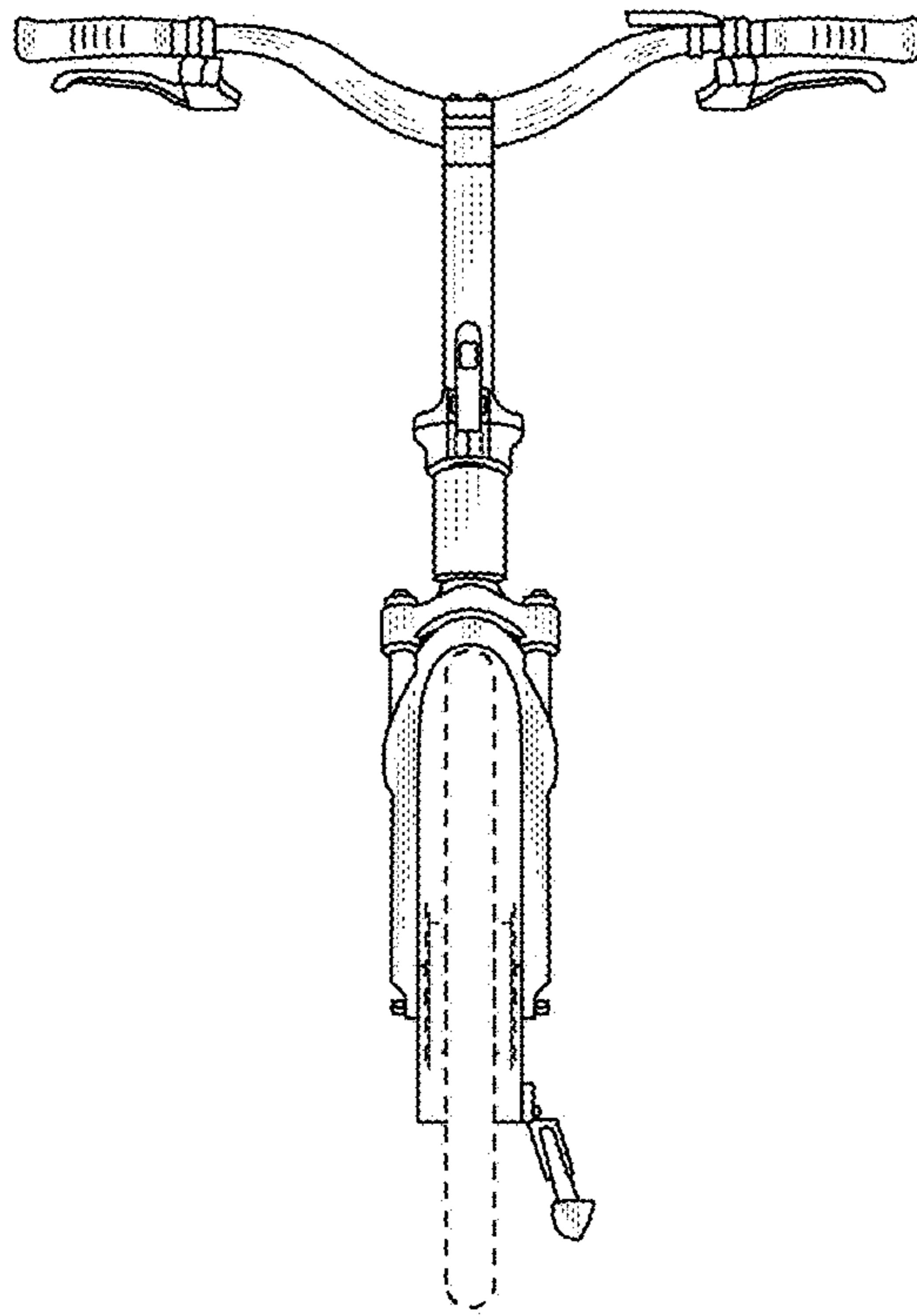

FIG. 4

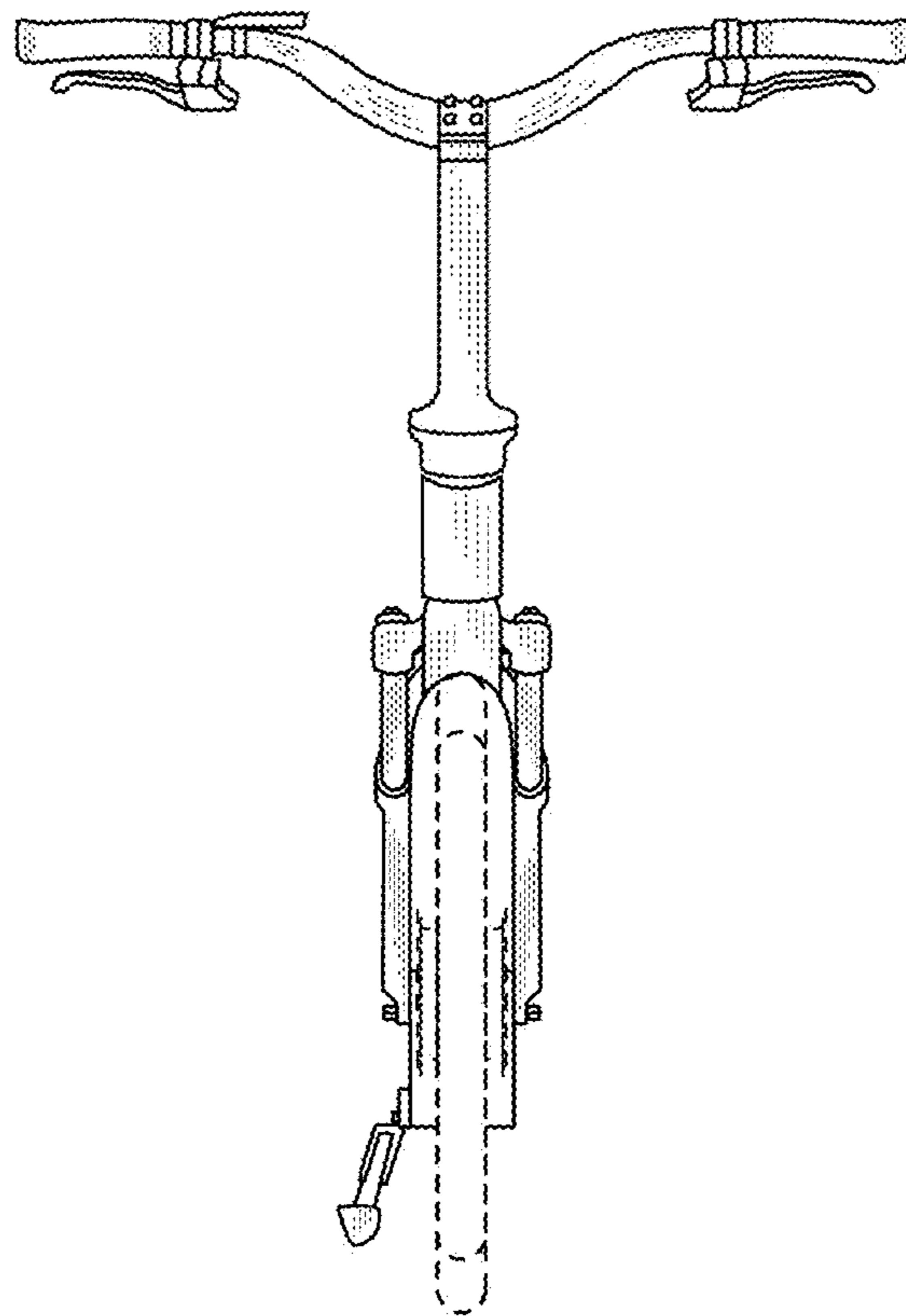

FIG. 5

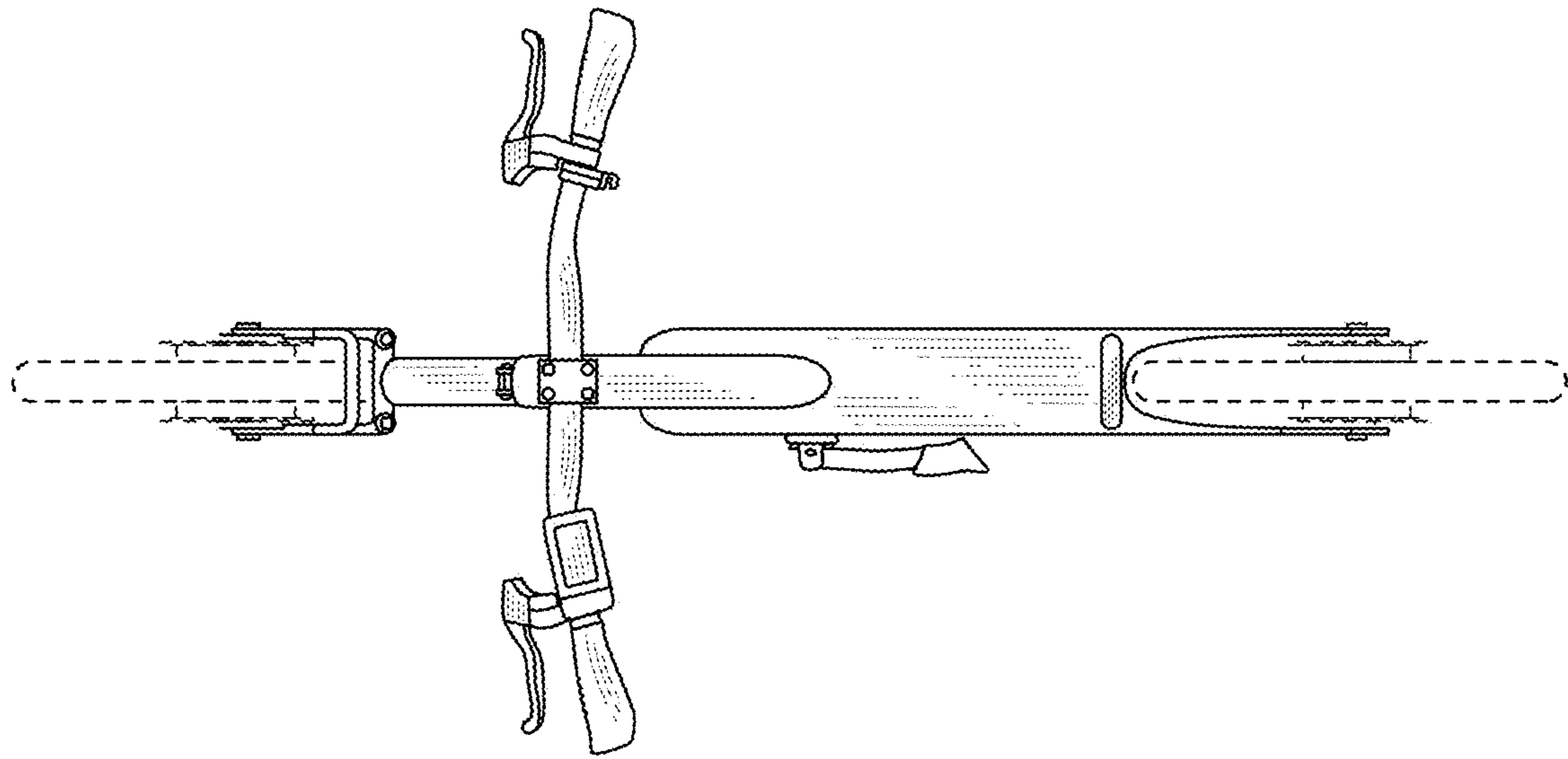

FIG. 6