



US00D928649S

(12) **United States Design Patent** (10) **Patent No.:** **US D928,649 S**
Coin (45) **Date of Patent:** **** Aug. 24, 2021**

(54) **ARTICLE OF JEWELRY**
(71) Applicant: **ROBERTO COIN S.p.A.**, Vicenza (IT)
(72) Inventor: **Roberto Coin**, Vicenza (IT)
(73) Assignee: **ROBERTO COIN S.p.A.**
(**) Term: **15 Years**

5,188,679 A * 2/1993 Kretchmer A44C 9/00
148/538
D371,980 S * 7/1996 Gardner D11/4
D379,600 S * 6/1997 Gardner D11/27
D430,814 S * 9/2000 Lauper D11/26
D454,314 S * 3/2002 Stewart D11/27

(Continued)

(21) Appl. No.: **29/771,063**

(22) Filed: **Feb. 19, 2021**

Related U.S. Application Data

(62) Division of application No. 29/617,565, filed on Sep. 14, 2017.

(30) **Foreign Application Priority Data**

Mar. 17, 2017 (EM) 003806223
Jun. 23, 2017 (EM) 004064244

(51) **LOC (13) Cl.** **11-01**

(52) **U.S. Cl.**
USPC **D11/4; D11/27**

(58) **Field of Classification Search**
USPC D11/1-25, 26-39
CPC A44C 5/00; A44C 5/0007; A44C 5/0014;
A44C 5/0023; A44C 5/003; A44C
5/0038; A44C 5/0046; A44C 5/0053;
A44C 5/0061; A44C 5/0069; A44C
5/0076; A44C 5/0084; A44C 5/0092;
A44C 5/02; A44C 5/022; A44C 5/025;
A44C 5/027; A44C 9/00; A44C 9/0007;
A44C 9/0015; A44C 9/0023; A44C
9/003; A44C 9/0038; A44C 9/0046; A44C
9/0053; A44C 9/0061; A44C 9/0069;
A44C 9/0076; A44C 9/0084; A44C
9/0092; A44C 9/02

See application file for complete search history.

(56) **References Cited**

U.S. PATENT DOCUMENTS

D133,402 S * 8/1942 Boucher D11/27
D273,771 S * 5/1984 Bulgari D11/34

OTHER PUBLICATIONS

[Online] "Introducing the Sauvage Prive . . ." <https://blog.hydeparkjewelers.net/hpj/2017/10/introducing-the-sauvage-prive-collection-by-roberto-coin/>. Retrieved May 6, 2021. Posted online Oct. 18, 2017.*

Primary Examiner — Melanie Pellegrini

(74) *Attorney, Agent, or Firm* — The Belles Group, P.C.

(57) **CLAIM**

The ornamental design for an article of jewelry, as shown and described.

DESCRIPTION

FIG. 1 is a perspective view of an article of jewelry in accordance with a first embodiment of the new design; FIG. 2 is a left side view thereof; FIG. 3 is a right side view thereof; FIG. 4 is a front view thereof; FIG. 5 is a rear view thereof; FIG. 6 is a top view thereof; FIG. 7 is a bottom view thereof; FIG. 8 is a perspective view of an article of jewelry in accordance with a second embodiment of the new design; FIG. 9 is a left side view thereof; FIG. 10 is a right side view thereof; FIG. 11 is a front view thereof; FIG. 12 is a rear view thereof; FIG. 13 is a top view thereof; and, FIG. 14 is a bottom view thereof.

1 Claim, 14 Drawing Sheets

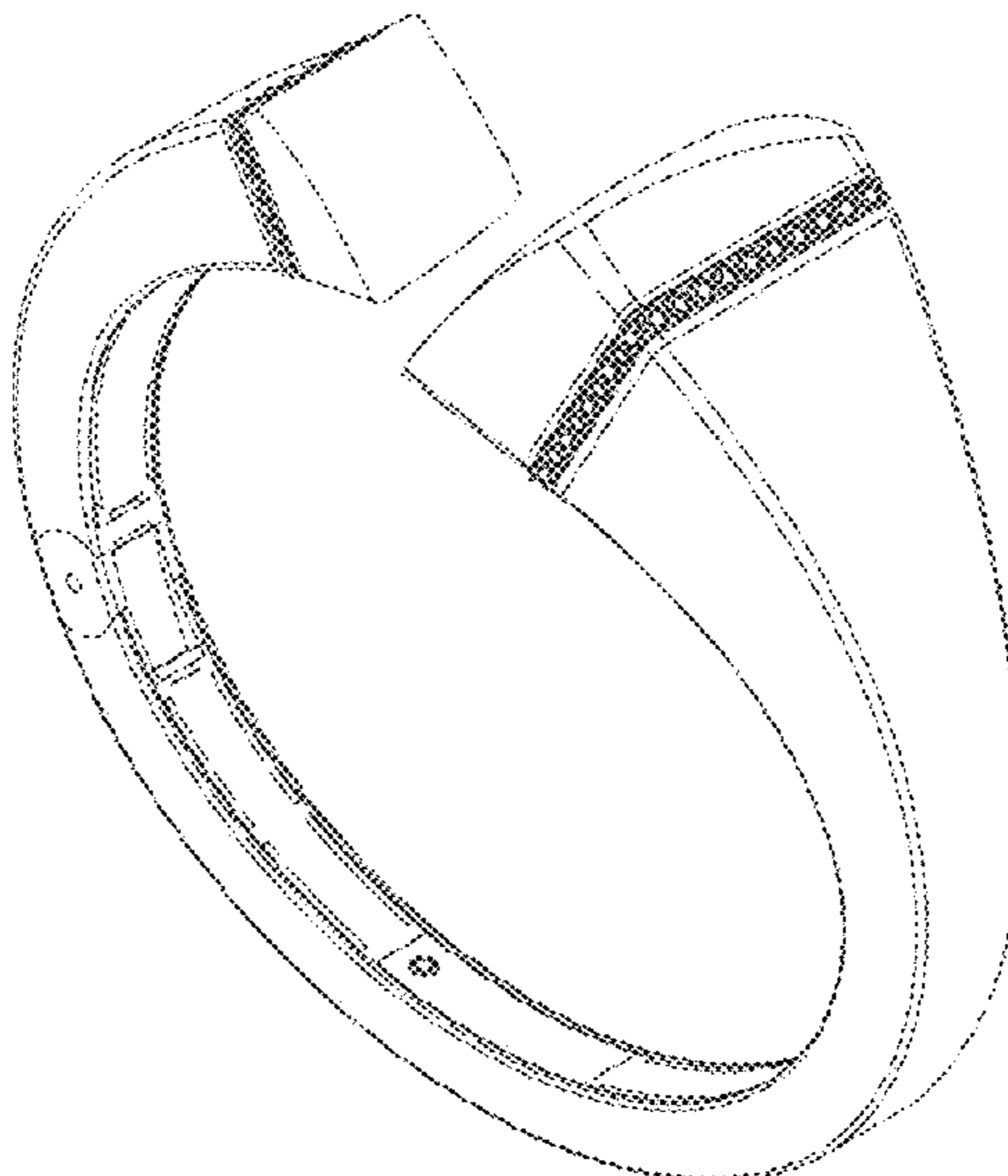

(56)

References Cited

U.S. PATENT DOCUMENTS

D815,973 S *	4/2018	Coin	D11/5
D820,141 S *	6/2018	Korhammer	D11/4
D830,218 S *	10/2018	Silvestri	D11/4
D872,617 S *	1/2020	Parvex	D11/4
D884,539 S *	5/2020	Zhang	D11/4
D896,680 S *	9/2020	Sivriere	D11/34

* cited by examiner

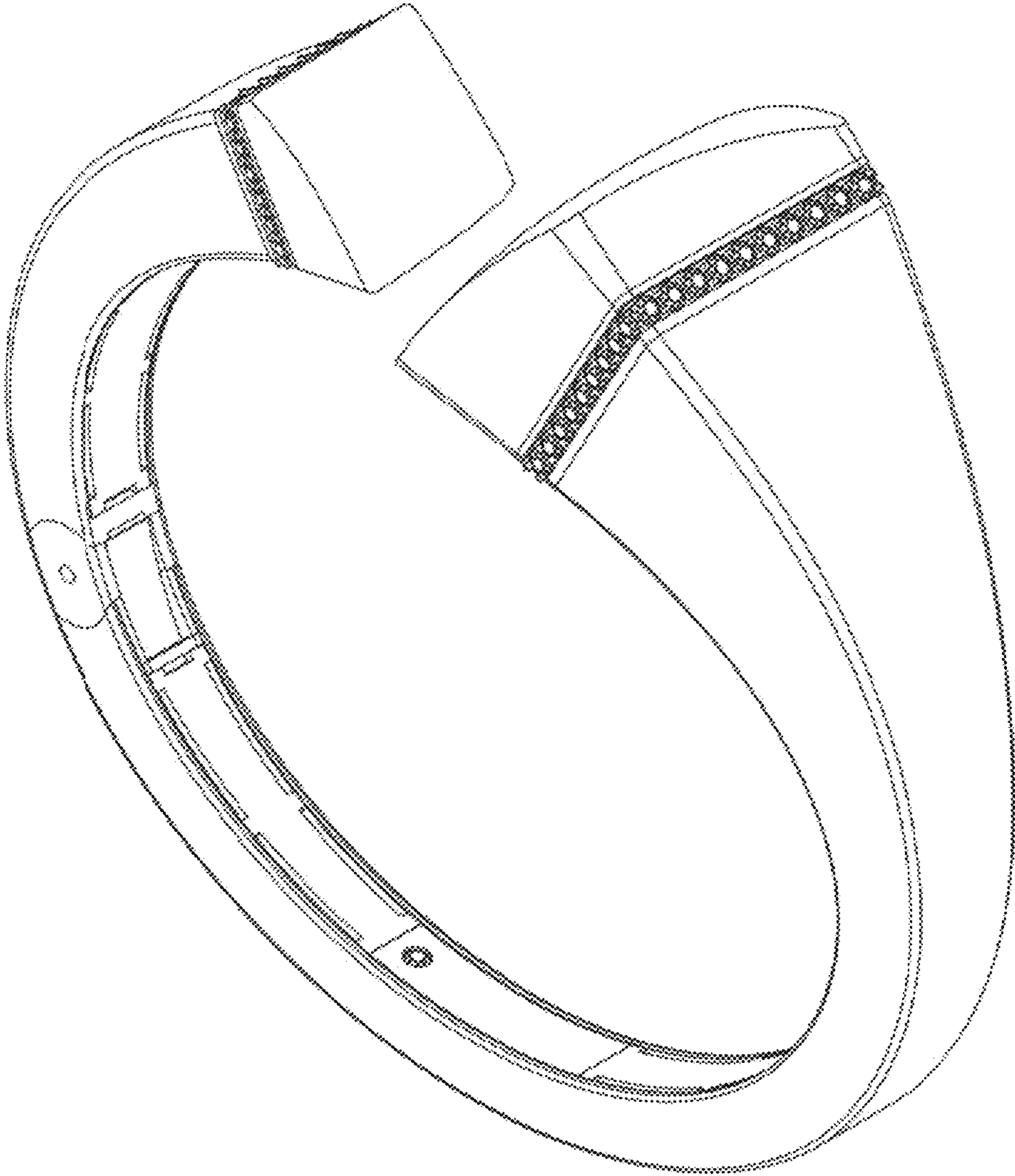

FIG. 1

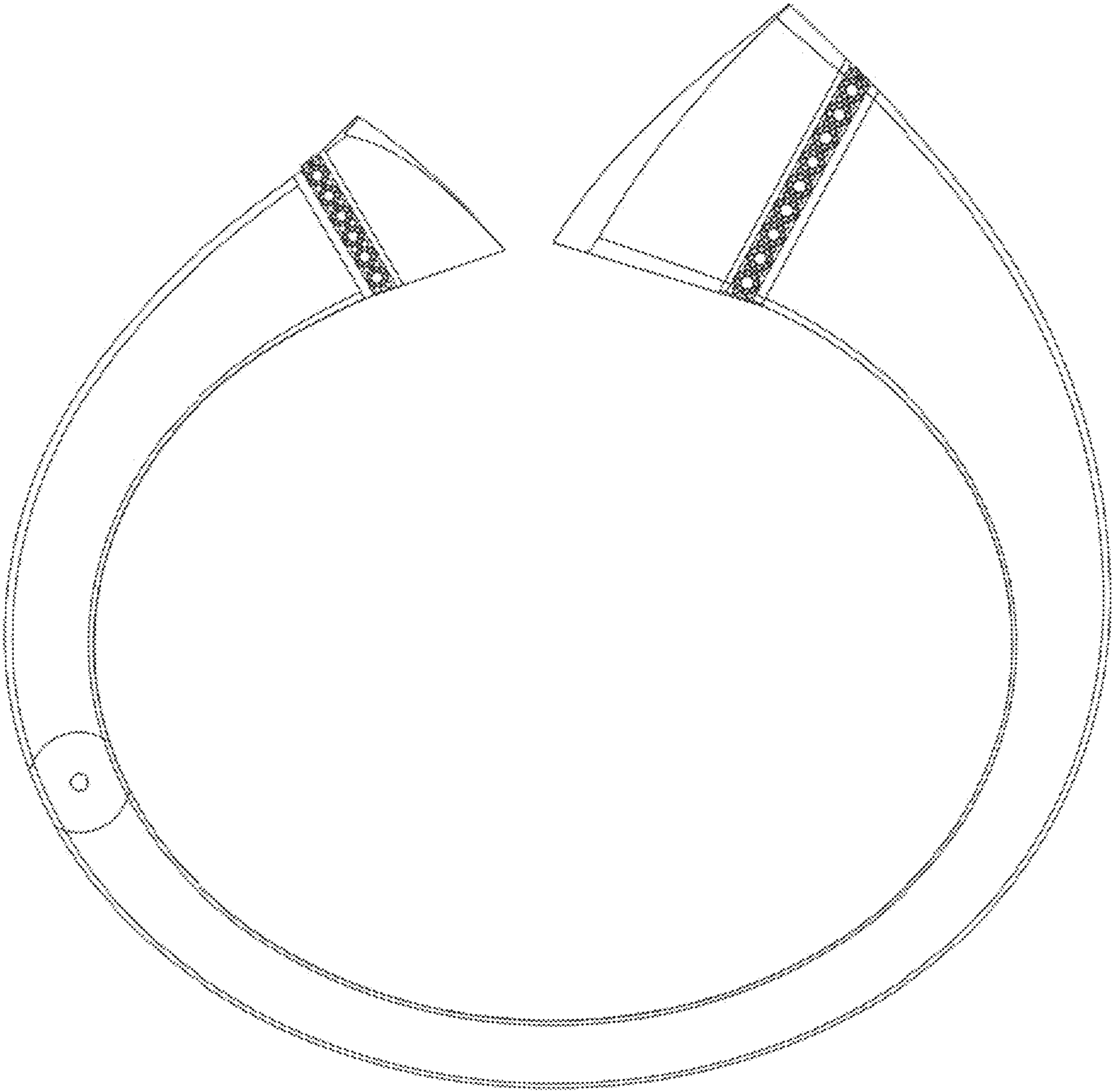

FIG. 2

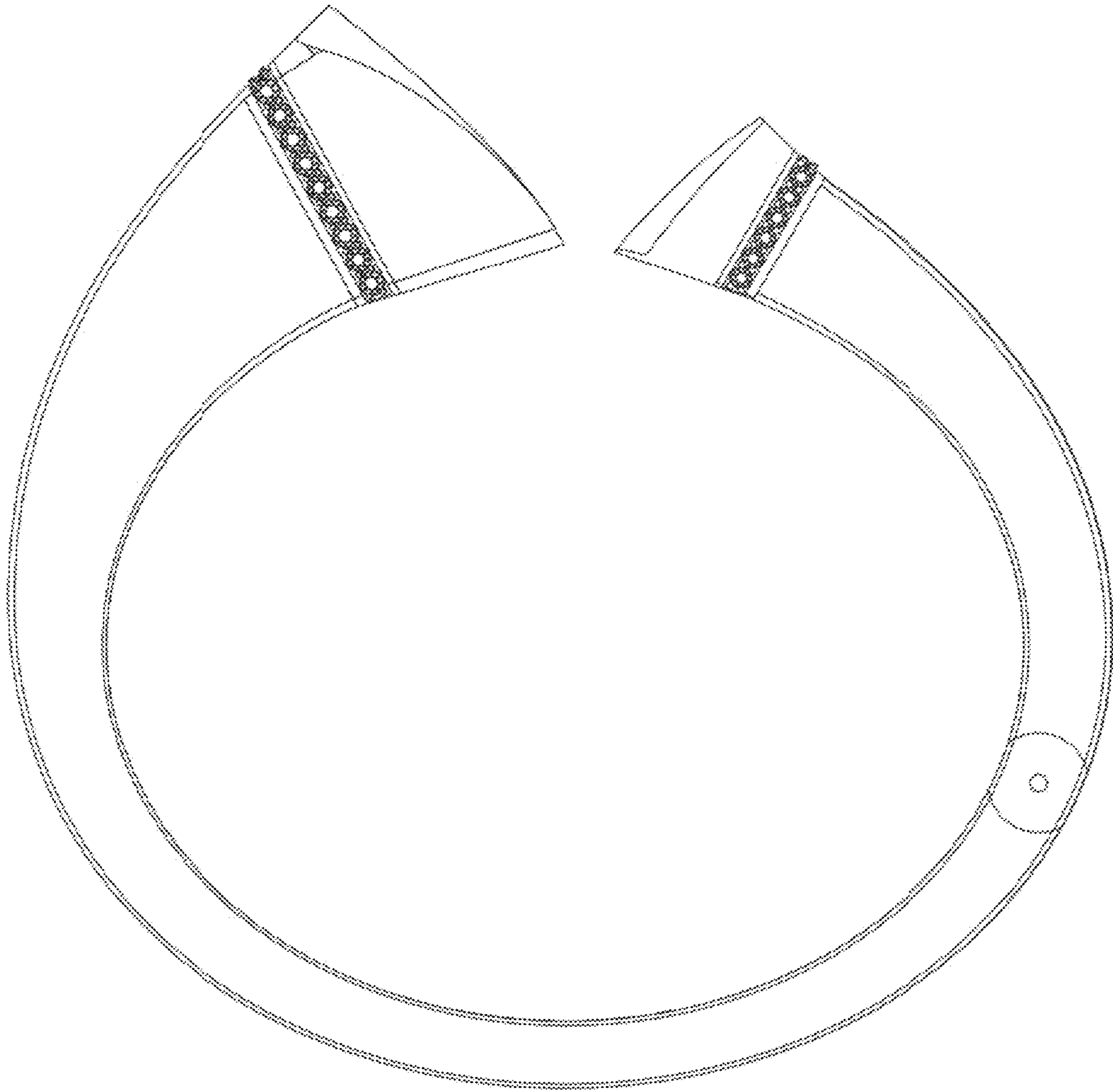

FIG. 3



FIG. 4

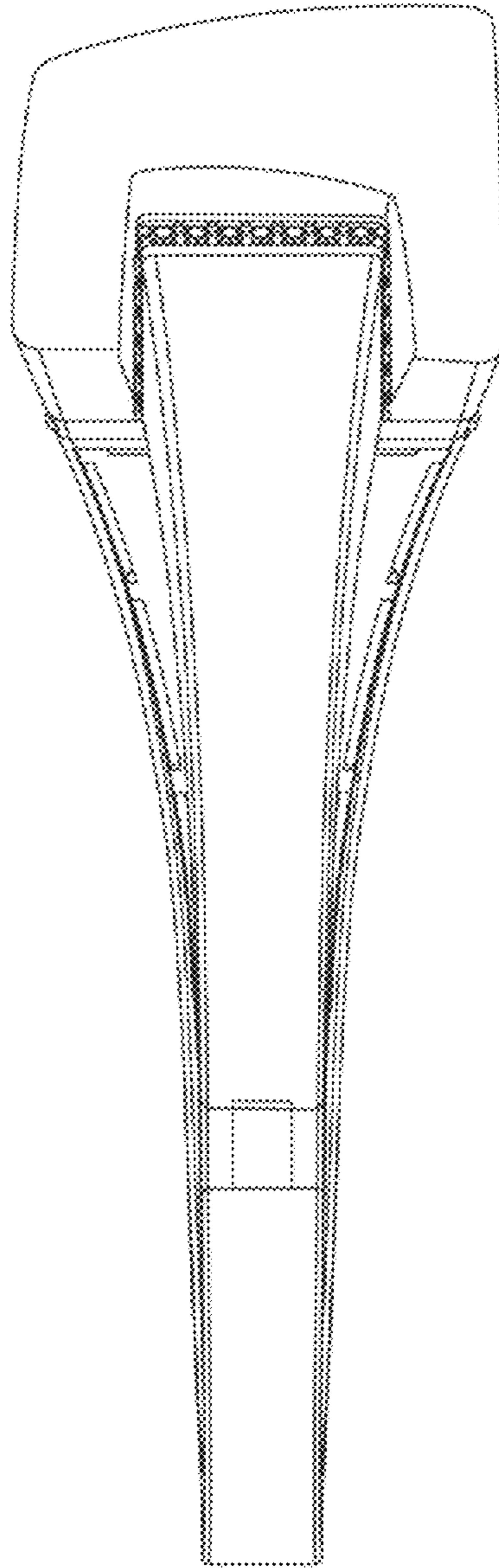

FIG. 5

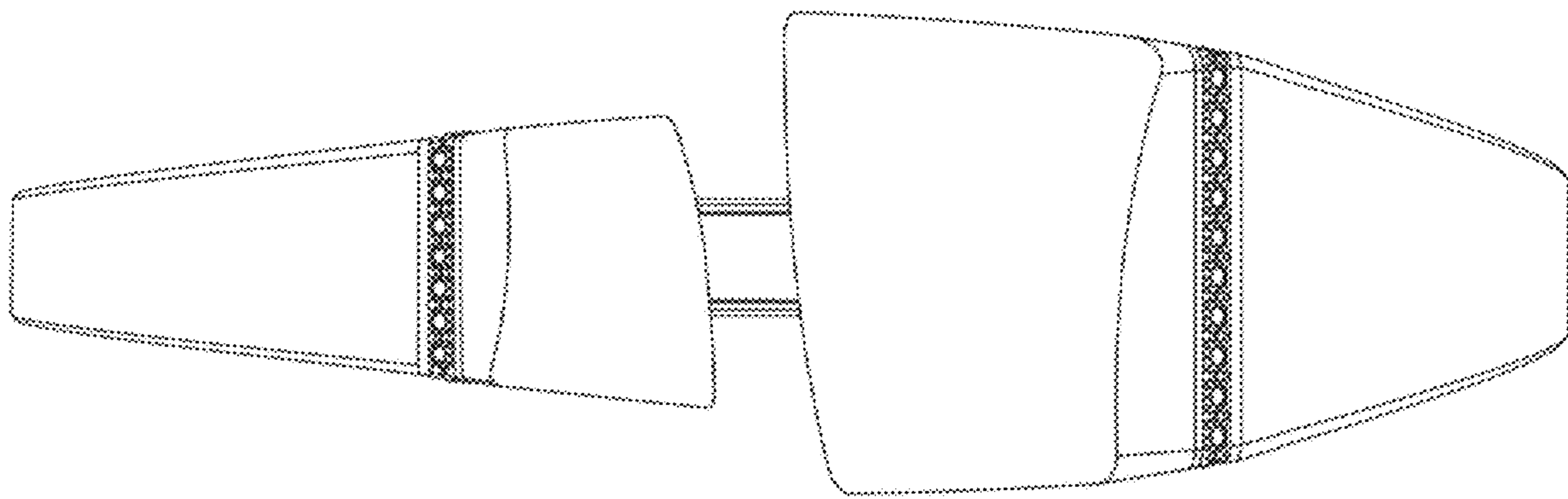

FIG. 6

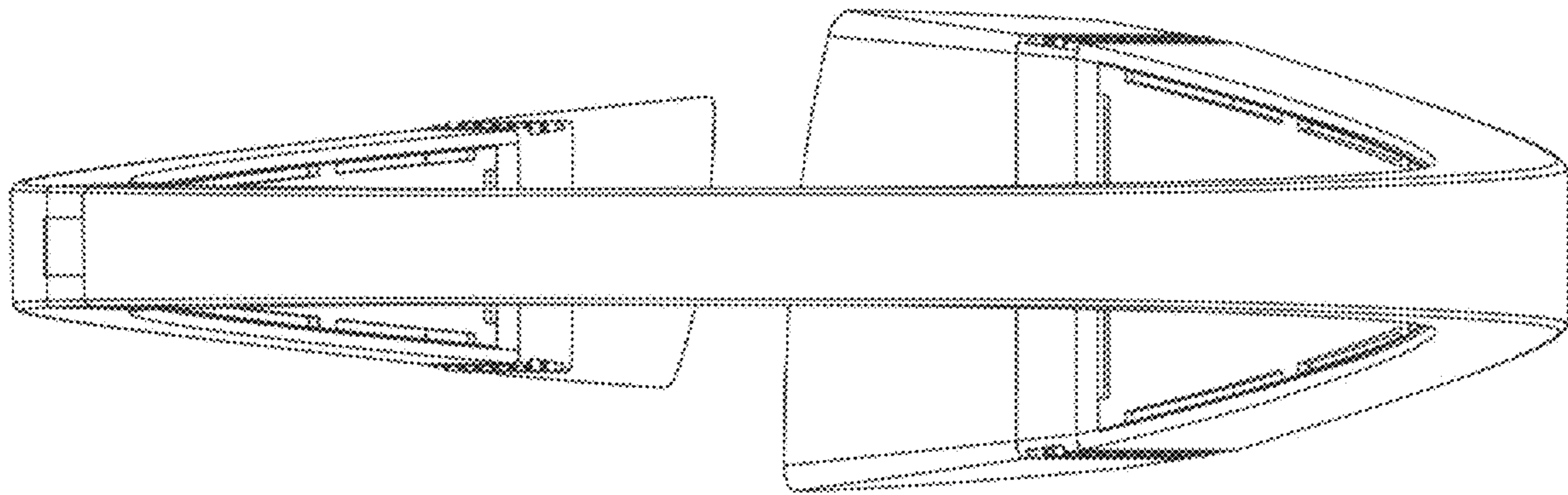

FIG. 7

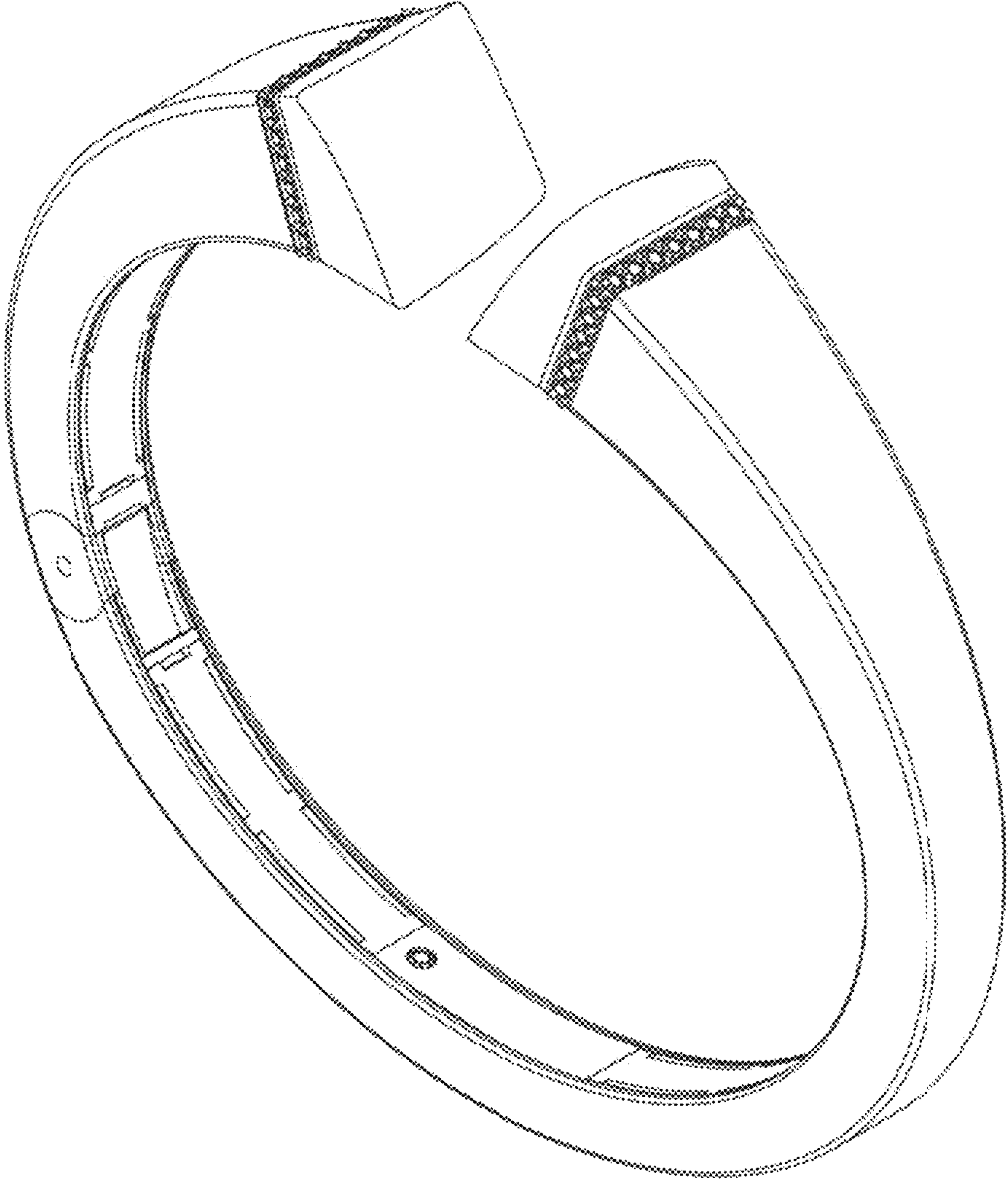

FIG. 8

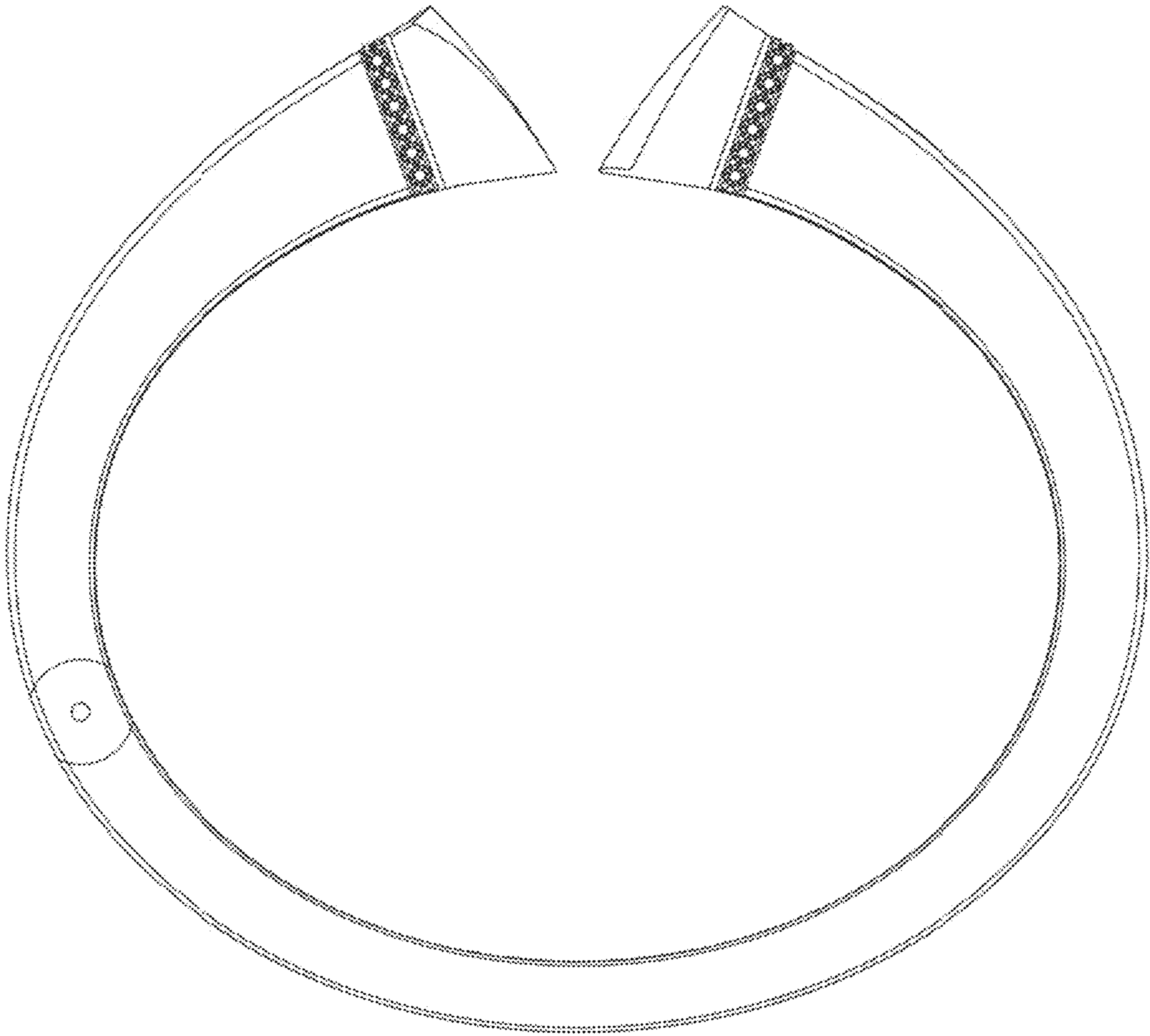

FIG. 9

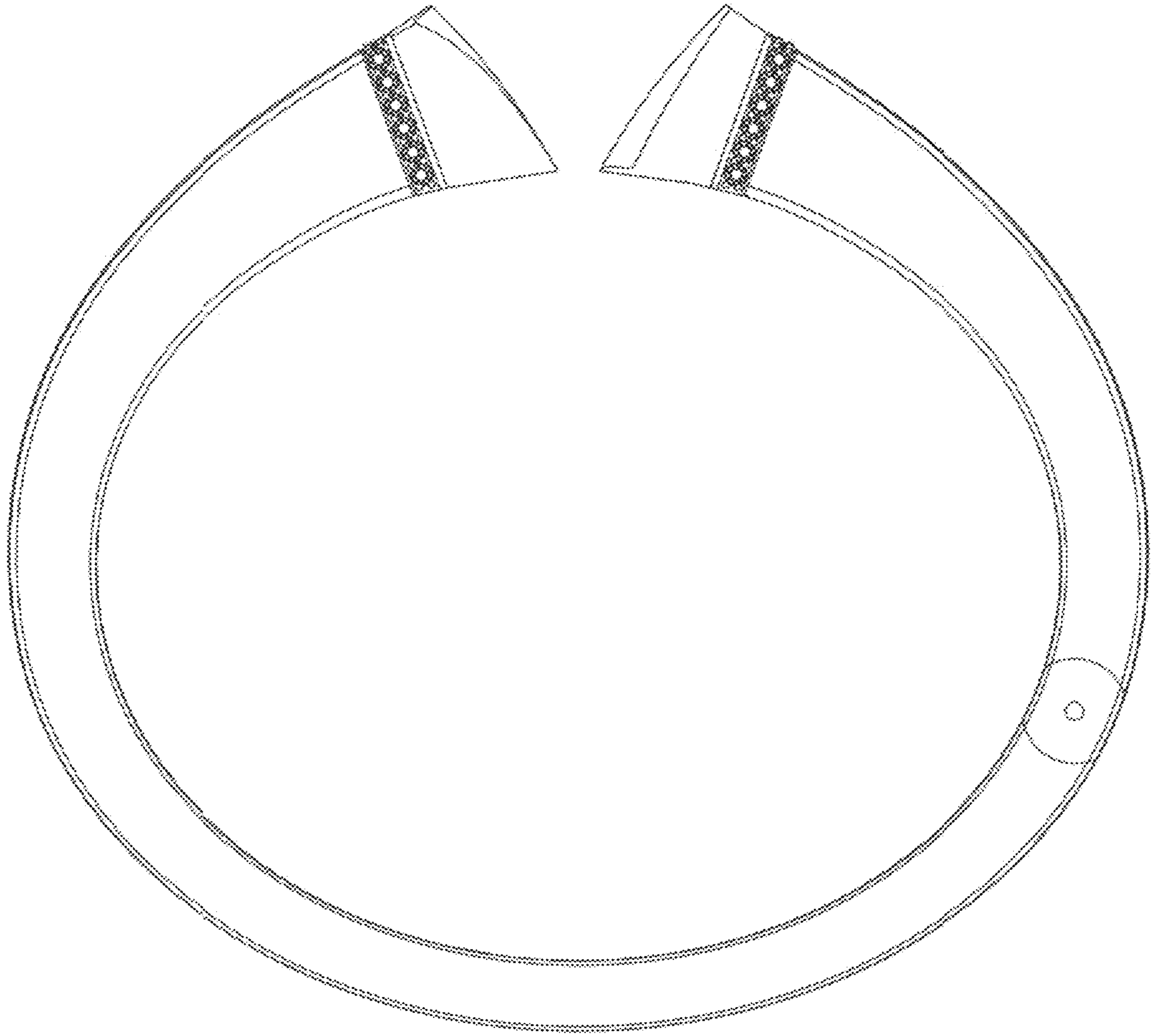

FIG. 10

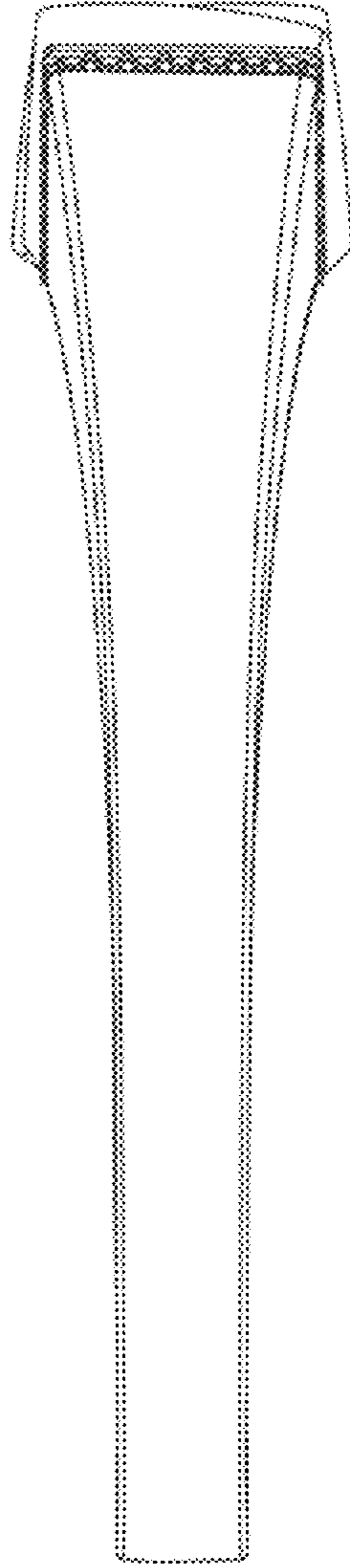

FIG. 11

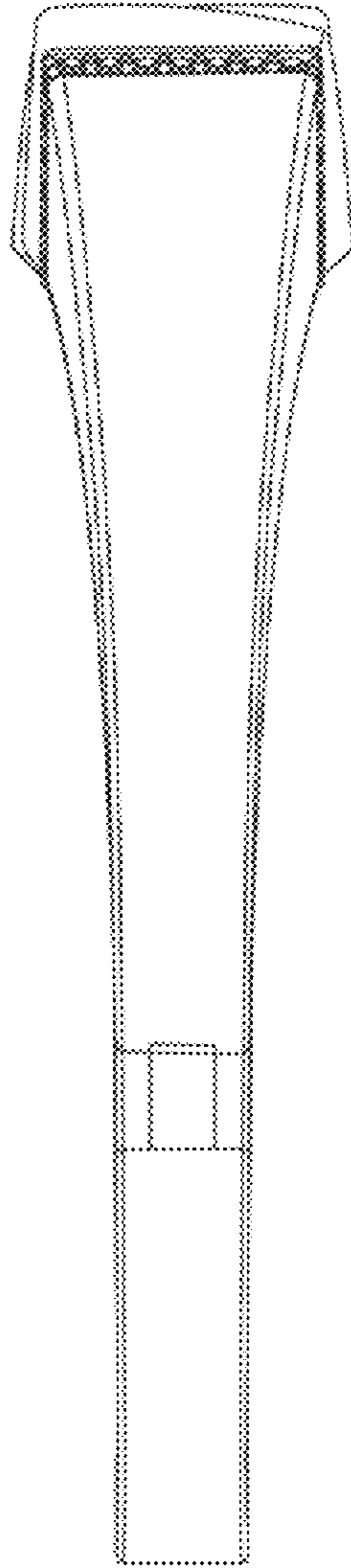

FIG. 12

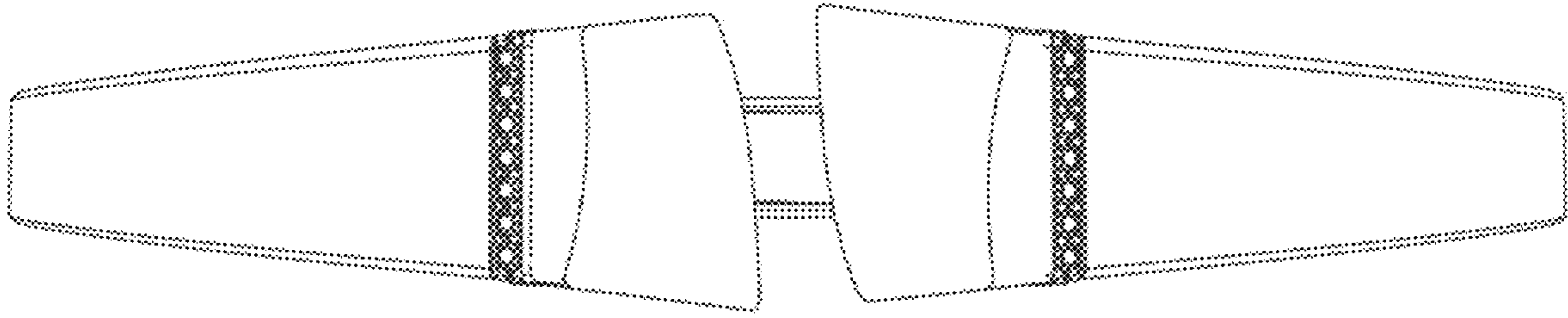

FIG. 13

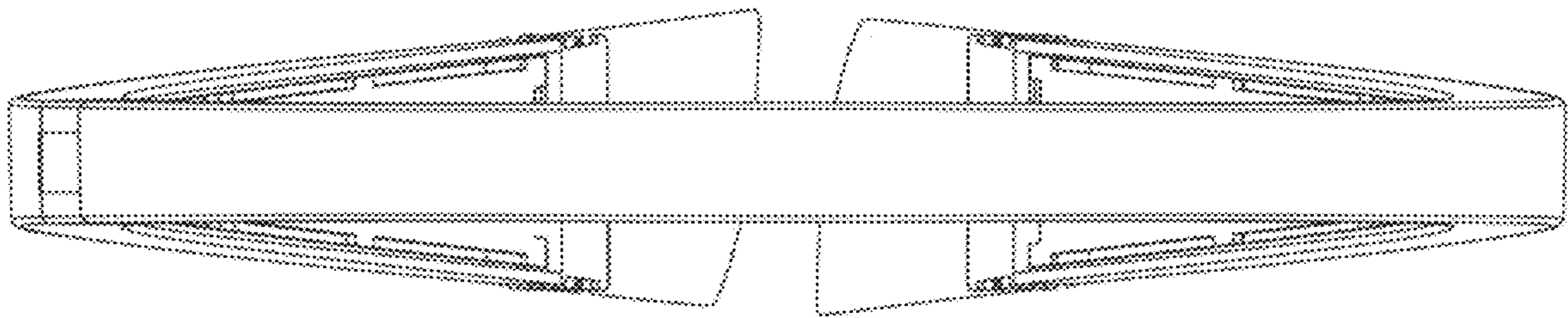

FIG. 14