



US00D928633S

(12) **United States Design Patent** (10) **Patent No.:** **US D928,633 S**  
**Register et al.** (45) **Date of Patent:** **\*\* Aug. 24, 2021**

(54) **WATCH WITH DISPLAY**  
(71) Applicant: **Garmin Switzerland GmbH**,  
Schaffhausen (CH)  
(72) Inventors: **Todd P. Register**, Olathe, KS (US);  
**Ryan A. Hoban**, Overland Park, KS  
(US); **Christopher J. Hanshew**,  
Lenexa, KS (US)  
(73) Assignee: **Garmin Switzerland GmbH**

D395,244 S \* 6/1998 Riley ..... D10/32  
D417,158 S 11/1999 Krauss  
D459,241 S 6/2002 Bodino  
D471,115 S 3/2003 Buechner  
6,577,558 B1 6/2003 Ricci  
D504,624 S 5/2005 Bodino  
D538,182 S 3/2007 Lalo  
D573,486 S 7/2008 Sanz  
D585,310 S 1/2009 Allison  
D592,975 S 5/2009 Markl  
D607,346 S 1/2010 Bove et al.  
(Continued)

(\*\*) Term: **15 Years**

**OTHER PUBLICATIONS**

(21) Appl. No.: **29/715,804**

Moto 360 Sport, [site visited Oct. 1, 2019] <https://www.motorola.com.au/products/moto-360-sport>; published before Aug. 8, 2019.

(22) Filed: **Dec. 4, 2019**

(Continued)

(51) **LOC (13) Cl.** ..... **10-02**

(52) **U.S. Cl.**  
USPC ..... **D10/38**; D14/344

*Primary Examiner* — Katherine Glennon  
(74) *Attorney, Agent, or Firm* — Samuel M. Korte; Max M. Ali

(58) **Field of Classification Search**  
USPC ..... D10/30–39, 65, 70, 97, 98, 122, 132,  
D10/128; D14/250, 344, 440; D24/167,  
D24/186  
CPC ..... G04B 37/005; G04B 37/0058; G04B  
37/0084; G04B 37/087; G04B 37/12;  
A44C 5/00; A44C 5/02; A44C 5/0007;  
A44C 5/0015; A44C 5/0023; A44C  
5/0053; A44C 5/147; G06F 1/163; A61B  
5/681

(57) **CLAIM**

The ornamental design for a watch with display, as shown and described.

See application file for complete search history.

**DESCRIPTION**

FIG. 1 is a front perspective view of a watch with display according to the present invention;  
FIG. 2 is a rear perspective view of the watch with display;  
FIG. 3 is a front view of the watch with display;  
FIG. 4 is a rear view of the watch with display;  
FIG. 5 is a left view of the watch with display;  
FIG. 6 is a right view of the watch with display;  
FIG. 7 is a top side view of the watch with display; and,  
FIG. 8 is a bottom side view of the watch with display.  
The broken lines shown in the drawings represent portions of the watch with display that form no part of the claimed design.

(56) **References Cited**

**U.S. PATENT DOCUMENTS**

D222,784 S 12/1971 Granges  
3,733,809 A 5/1973 Reiter et al.  
3,740,944 A 6/1973 Chopard  
3,901,023 A 8/1975 Uebelhardt  
D300,513 S \* 4/1989 Tsukahara ..... D10/30  
D317,265 S 6/1991 Giolla et al.  
5,226,023 A 7/1993 Grimm

**1 Claim, 4 Drawing Sheets**

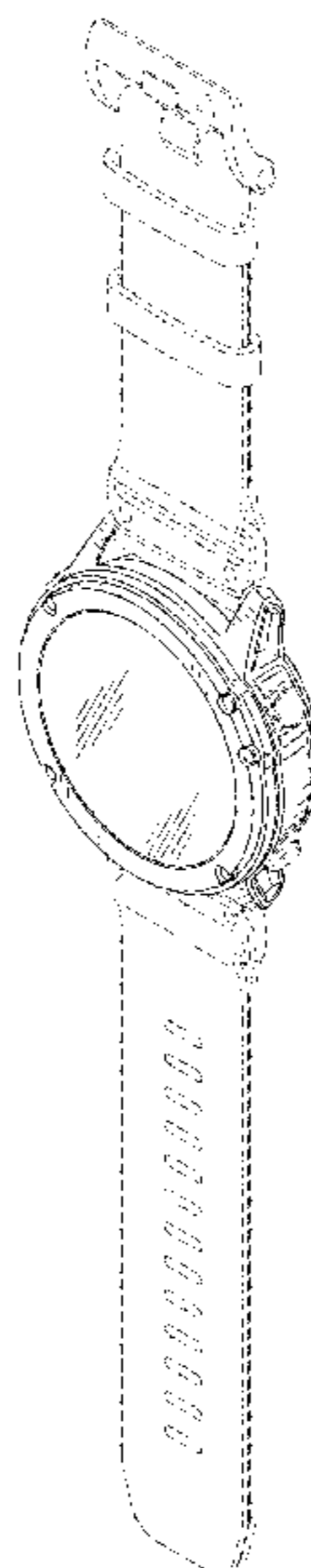

(56)

## References Cited

## U.S. PATENT DOCUMENTS

D610,922	S	3/2010	Lammers-Meis et al.	
D633,812	S	3/2011	Yurman	
D658,079	S	4/2012	Emch	
D658,518	S	5/2012	Behling	
D660,727	S	5/2012	Parmigiani	
D661,206	S	6/2012	Register et al.	
D664,865	S	8/2012	Luk Ying Yee	
D682,712	S	5/2013	Lammers-Meis et al.	
D718,167	S	* 11/2014	Yliluoma	D10/128
D742,762	S	* 11/2015	Syoubayashi	D10/30
D756,240	S	5/2016	Register et al.	
D773,944	S	* 12/2016	Wang	D10/70
D789,808	S	* 6/2017	Kimura	D10/39
D805,406	S	12/2017	Register et al.	
D814,946	S	* 4/2018	Emmenegger	D10/39
D819,627	S	* 6/2018	Boukai	D14/344
D836,465	S	12/2018	Register	
10,474,194	B1	* 11/2019	Ell	G06F 1/1656
D868,778	S	* 12/2019	Reivo	D14/344
D905,576	S	* 12/2020	Lillquist	D10/38
D912,534	S	* 3/2021	Matsuda	D10/30
D912,539	S	* 3/2021	Connor	D10/38
D912,540	S	* 3/2021	Connor	D10/38
2019/0379122	A1	* 12/2019	Kenkel	H01Q 1/273

## OTHER PUBLICATIONS

Etienne, Stefan, Samsung Galaxy Sport leak shows a sleek bezel-less smartwatch, <https://www.theverge.com/2019/2/4/18211261/samsung-galaxy-sport-leak-shows-a-sleek-bezel-less-smartwatch>; published before Aug. 8, 2019.

Garmin Forerunner 405, published Jan. 2008.

Garmin Forerunner 610, published Mar. 2011.

Huawei Watch, Timeless Design, Smart Within; <http://consumer.huawei.com/en/wearables/huawei-watch/index.htm>; published prior to Dec. 15, 2016.

Tissot T-Touch Titanium, <https://www.tissotwatches.com/en-gb/shop/tissot-t-touch-ii-titanium-gent-3.html>; published prior to Apr. 6, 2017.

Hublot Formula 1 King Power F1 Ceramic Limited SEALED, [site visited Nov. 16, 2017] <http://www.chrono24.com/hublot/formula-1-king-power-f1-ceramic-limited-sealed-id1818204.htm>; published prior to Dec. 15, 2016.

Raphael, Jr; Moto 360 Review: An elegant smartwatch with exceptional features, posted Sep. 15, 2014, <http://www.computerworld.com/article/2643100/moto-360-review-an-elegant-smartwatch-with-exceptional-features.html>; published prior to May 8, 2015.

Cookoo, the connected watch, [site visited Oct. 14, 2015] <http://www.cookoo2.com/>; published prior to May 21, 2015.

Linde Werdelin, Spidolite watches, <http://www.lindewerdelin.com/products/watches/spidolite>; published prior to May 21, 2012.

Ralph Lauren, la collection automotive, [http://www.ralphlauren.fr/category/index.jsp?categoryId=53519341&ab=fr\\_FR-Watches\\_LP\\_Slot\\_5\\_S1](http://www.ralphlauren.fr/category/index.jsp?categoryId=53519341&ab=fr_FR-Watches_LP_Slot_5_S1); published prior to Dec. 15, 2016.

Suunto sports watches for athletes, runners, outdoor adventurers, [site visited Feb. 23, 2017, <http://www.suunto.com/en-US/Product-search/See-all-Sports-Watches/?sortby=-New&searchTerm=traverse&page=0>]; published prior to Dec. 15, 2016.

Tag Heuer calibre heuer 01—chronograph titanium 43 mm, [site visited Nov. 23, 2016] <http://www.tagheuer.com/int-en/luxury-watches/carrera/carrera-calibre-heuer-01-chronograph-titanium-43mm-grey-others-bracelet>; published prior to Aug. 15, 2016.

Tag Heuer Carrera Calibre 1887 Automatic Chronograph 43 MM, [site visited Nov. 23, 2016] <http://www.tagheuer.com/int-en/luxury-watches/carrera/carrera-calibre-186-7automatic-chronograph43-mm-black-steel-bracelet-car2a10-ba0799>; published prior to Aug. 15, 2016.

Tissot T-touch tactile watch, [site visited Feb. 23, 2017] <http://www.t-touch.com/en-en/#!/t-touch-expert-solar>; published prior to Dec. 15, 2016.

Practical Travel Gear, travel gear reviews, Timex Expedition E-compass Titanium Watch, [site visited Oct. 10, 2018] <http://practicaltravelgear.blogspot.com/2008/07/timex-expedition-e-compass-titanium.html>; published Jul. 2008.

Amazon Fashion, Salvatore Ferragamo Men's, black carbon fiber and back rubber watch, [site visited Nov. 16, 2017] <https://www.amazon.com/Salvatore-Ferragamo-F55LGO6877-S113-Carbon/dp/B007-O20FO8>; published prior to Apr. 6, 2017.

Amazon Fashion, Welder Men's k28-7100 Chronograph Black Ion-Plated Stainless Steel Round Watch, <https://www.amazon.com/Welder-K28-7100-Chronograph-Ion-Plated-Stainless/dp/B001PRFJOY>; published prior to Dec. 15, 2016.

Smith, Craig, Suunto X10, GPS Running Watch Review, [site visited Oct. 10, 2018] <http://www.gpsrunningwatchreview.com/reviews/suunto-x10-review>; published Nov. 2010.

Audemars Piguet—Swiss Luxury Watches, royal oak offshore, [site visited Nov. 16, 2017] <https://www.audemarspiguet.com/en/watch-collection/royal-oak-offshore/>; published prior to Dec. 15, 2016.

Bloomingdales—the greatest gift guide; [https://www.bloomingdales.com/shop/product/g-shock-g-steel-53.8mm?ID=2725-010&pla\\_country=US&cm\\_mmc=Google-PLA-ADC--Jewelry%20%26%20Accessories-NA--\\_G-shock\\_-869232168203USA&CAWELAID=120156070005934945&CAGPSPN=pla&CAAGID=47685648719&CATCI=pla-383074889643&CATARGETID=120156070006241384&cadevice=c&gclid=EALa1OobChMlvMbeIL3B1wIVk6Ds-Ch3QDwNMEAQYASABEqJNgvD\\_BwE](https://www.bloomingdales.com/shop/product/g-shock-g-steel-53.8mm?ID=2725-010&pla_country=US&cm_mmc=Google-PLA-ADC--Jewelry%20%26%20Accessories-NA--_G-shock_-869232168203USA&CAWELAID=120156070005934945&CAGPSPN=pla&CAAGID=47685648719&CATCI=pla-383074889643&CATARGETID=120156070006241384&cadevice=c&gclid=EALa1OobChMlvMbeIL3B1wIVk6Ds-Ch3QDwNMEAQYASABEqJNgvD_BwE); published prior to Dec. 15, 2016.

Suunto Spartan, <https://www.suunto.com/en-us/Sports-Watch-Collections/Suunto-Spartan-Collection/>; published prior to Jun. 15, 2018.

Suunto Kailash, <https://www.suunto.com/en-us/Watch-Collection/Suunto-Kailash-Collection/>; published prior to Jun. 15, 2018.

Suunto Elementum Ventus Brown Leather, [site visited Oct. 10, 2018] <https://www.suunto.com/en-us/Products/Sports-Watches/Suunto-Elementum-Ventus/Suunto-Elementum-Ventus-Brown-Leather>; published prior to Apr. 6, 2017.

Suunto Ambit In-Depth Review, [www.dcrainmaker.com/2012/04/suunto-ambit-in-depth-review.html](http://www.dcrainmaker.com/2012/04/suunto-ambit-in-depth-review.html); published prior to Sep. 29, 2015.

Suunto Ambit2 Black, integrated GPS watch with heart rate monitoring option, weather functions and suunto apps for all outdoor sports, [www.suunto.com/en-US/Products/Sports-Watches/Suunto-Ambit2/Suunto-Ambit2--Black/](http://www.suunto.com/en-US/Products/Sports-Watches/Suunto-Ambit2/Suunto-Ambit2--Black/); published prior to Sep. 29, 2015.

Casio MT G G-Shock Watch, [www.thearonloy.com/wp-content/uploads/2013/07/Casio-MT-G-G-Shock-Watch.jpg](http://www.thearonloy.com/wp-content/uploads/2013/07/Casio-MT-G-G-Shock-Watch.jpg); published prior to Sep. 29, 2015.

Casio Edifice 8, [www.watchtowhat.com/wp-content/uploads/2015/03/casio-edifice-8.jpg](http://www.watchtowhat.com/wp-content/uploads/2015/03/casio-edifice-8.jpg); published prior to Sep. 29, 2015.

Suunto Core, the outdoor watch, <https://www.suunto.com/en-us/Sports-Watch-Collections/Suunto-Core-Collection/>; published prior to Apr. 6, 2017.

Connor, Stephen W., U.S. Appl. No. 29/653,530; Watch With Display; filed Jun. 15, 2018.

Connor, Stephen W., U.S. Appl. No. 29/653,529; Watch With Display; filed Jun. 15, 2018.

Lee, Juhee, U.S. Appl. No. 29/701,151; Watch With Display; filed Aug. 8, 2019.

Lee, Juhee, U.S. Appl. No. 29/701,153; Watch With Display; filed Aug. 8, 2019.

Hublot Big Bang, <https://www.hublot.com/en/collection/big-bang/big-bang-steel-44?serie=19>, published before Dec. 4, 2019.

Hublot Classic Fusion Orlnski Titanium, <https://www.exquisitetimepieces.com/hublot-classic-fusion-orlnski-titanium.html>, printed Dec. 4, 2019.

Chrono24 Hublot 511.CM.1771.RX Hublot Classic Fusion Black Magic 45MM—<https://www.chrono24.com/hublot/classic-fusion-511cm1771rx-id9129728.htm>, printed Dec. 4, 2019.

\* cited by examiner

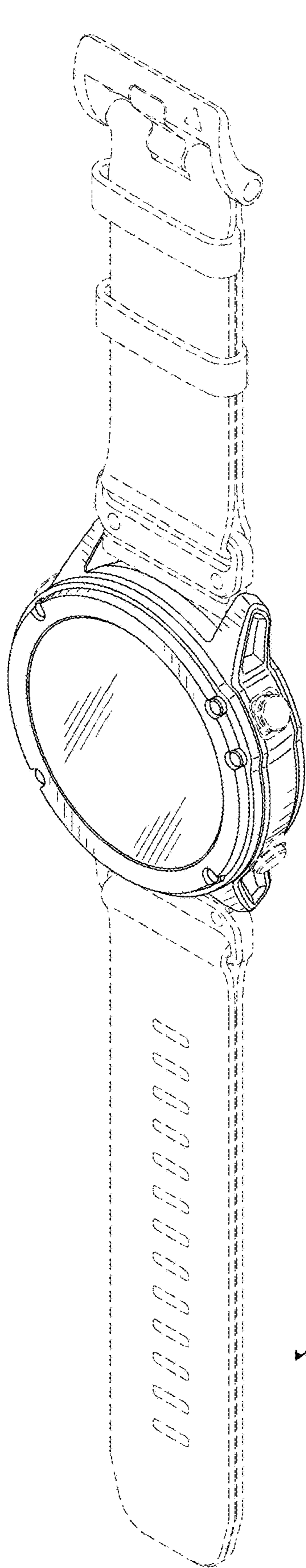

*Fig. 1*

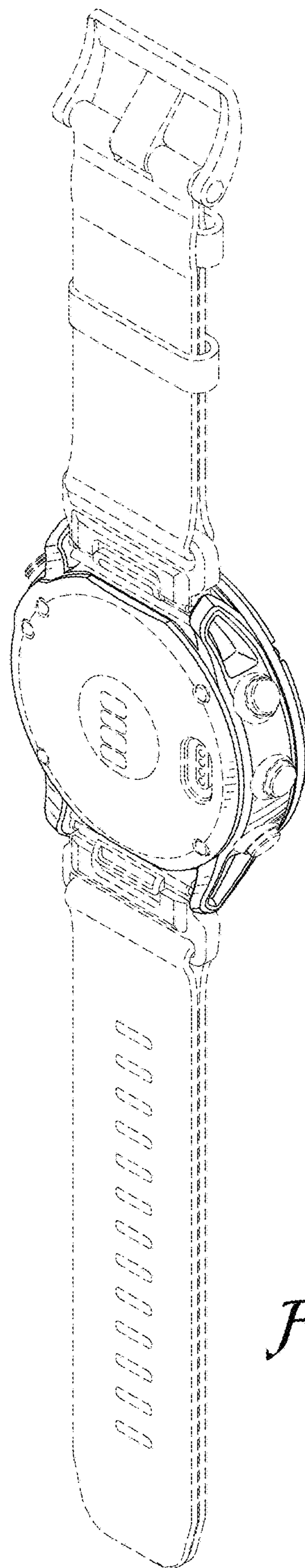

*Fig. 2*

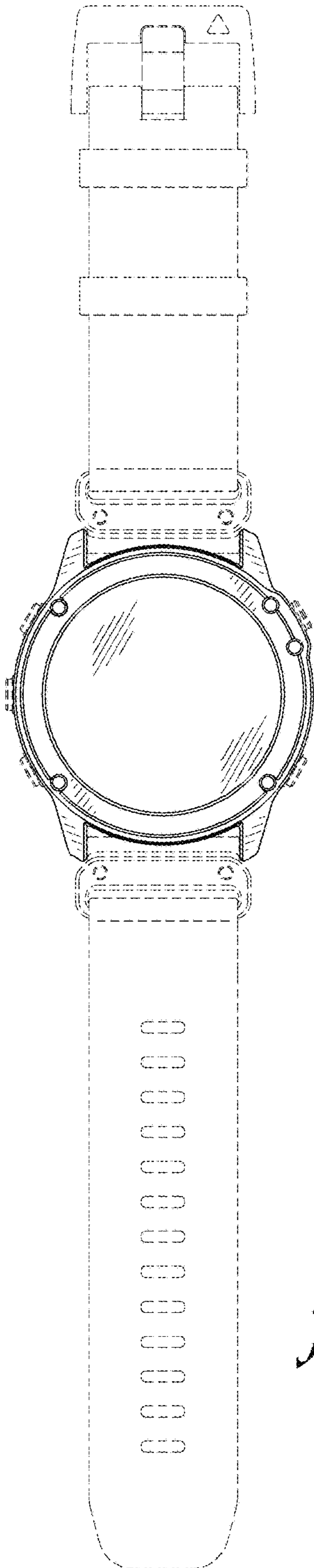

*Fig. 3*

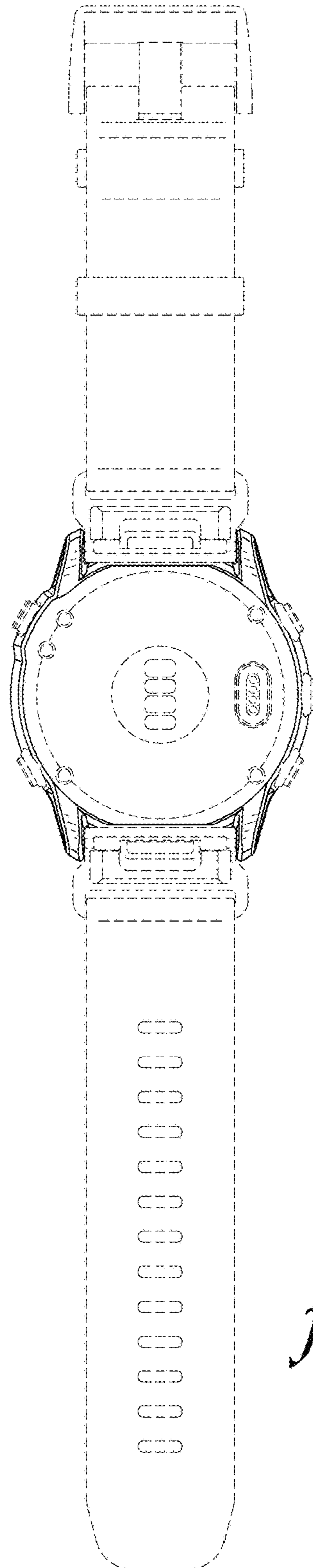

*Fig. 4*

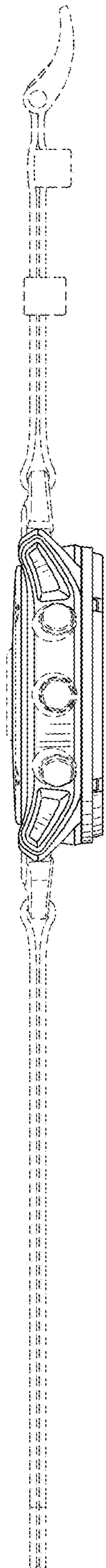

*Fig. 5*

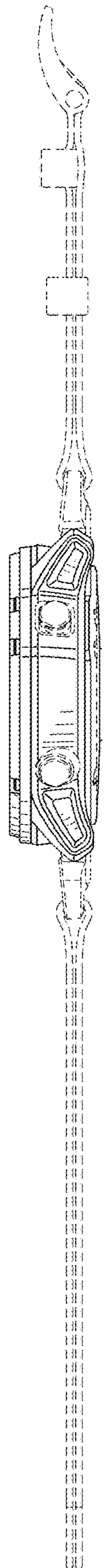

*Fig. 6*

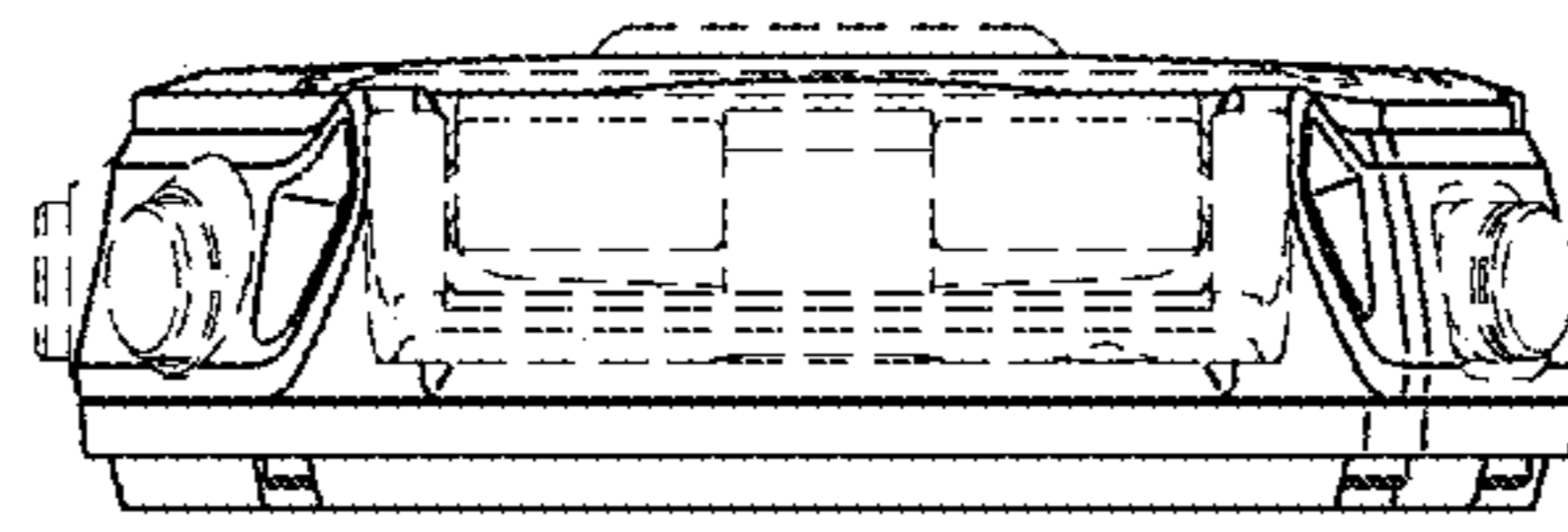

*Fig. 7*

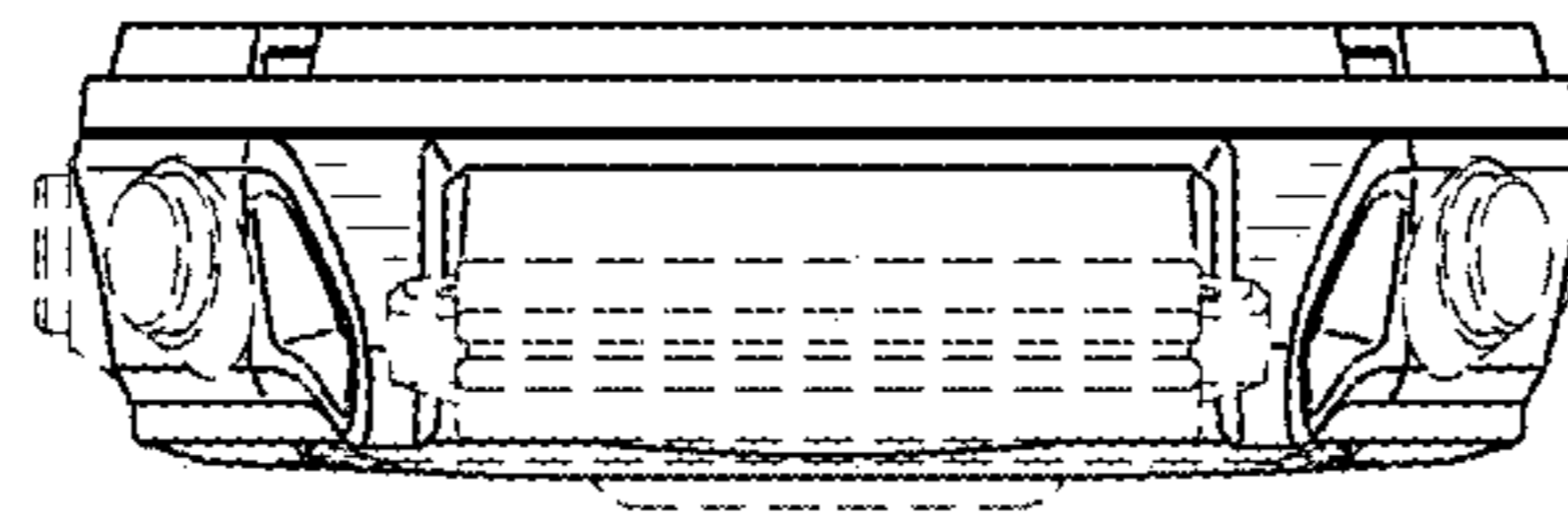

*Fig. 8*