



US00D928612S

(12) **United States Design Patent** (10) **Patent No.:** **US D928,612 S**  
**Picken et al.** (45) **Date of Patent:** **\*\* Aug. 24, 2021**

(54) **DISPLAY TRAY FOR PACKAGING OF ODOR ABSORBERS**

(71) Applicant: **Beaumont Products, Inc.**, Kennesaw, GA (US)

(72) Inventors: **Jeffrey M. Picken**, Kennesaw, GA (US); **Joseph P. Perushek**, Baraboo, WI (US)

(73) Assignee: **Beaumont Products, Inc.**, Kennesaw, GA (US)

(\*\*) Term: **15 Years**

(21) Appl. No.: **29/731,552**

(22) Filed: **Apr. 16, 2020**

(51) **LOC (13) Cl.** ..... **09-07**

(52) **U.S. Cl.**  
USPC ..... **D9/456**

(58) **Field of Classification Search**  
USPC ..... D9/414, 434, 435, 439, 440, 442-450, D9/452-457, 499, 503-505, 682, 685, D9/686, 424, 425, 736, 737; D7/387, D7/391, 392, 392.1, 396.1, 396.2, 396.4, D7/507, 509-511, 538, 900, 354, 554.3; D3/202, 203.2, 294, 318; D28/91, 91.1; D6/672  
CPC .. A61J 1/00; A61J 1/1412; B65D 1/00; B65D 1/02; B65D 1/10; B65D 1/46; B65D 5/46; B65D 41/00; B65D 41/38; B65D 41/56; B65D 41/62; B65D 47/00; B65D 47/06; B65D 47/08; B65D 2251/00; B65D 2543/00046; B65D 2543/00092; B65D 2543/00296

See application file for complete search history.

(56) **References Cited**

**U.S. PATENT DOCUMENTS**

D184,525 S \* 3/1959 Lurie ..... D9/424  
D190,974 S \* 7/1961 Salis ..... D9/737

D226,553 S \* 3/1973 Glaberson ..... D9/736  
3,734,279 A \* 5/1973 Fisher, Jr. .... B65D 71/70  
206/564  
3,856,137 A \* 12/1974 Brindley ..... B65D 25/107  
206/564  
D244,580 S \* 6/1977 Keough ..... D9/456  
D244,581 S \* 6/1977 Keough ..... D9/456  
D267,542 S \* 1/1983 Paone ..... D9/456  
D288,039 S \* 2/1987 LeBlanc ..... D19/75  
D352,454 S \* 11/1994 Krupa ..... D9/425  
5,794,796 A \* 8/1998 Weisburn ..... G11B 33/0461  
206/307.1  
D516,914 S \* 3/2006 Ducharme ..... D9/456  
D596,047 S \* 7/2009 Wonderley ..... D9/736  
D613,418 S \* 4/2010 Ryan ..... D24/229  
D630,526 S \* 1/2011 Wonderley ..... D9/749  
D643,751 S \* 8/2011 Wonderley ..... D9/749  
8,083,887 B2 \* 12/2011 LaRue ..... B65D 81/262  
156/290  
D656,821 S \* 4/2012 Marcoux ..... D9/456

(Continued)

*Primary Examiner* — Wendy L Arminio

(74) *Attorney, Agent, or Firm* — Thomas | Horstemeyer, LLP

(57) **CLAIM**

The ornamental design for a display tray for packaging of odor absorbers, as shown and described.

**DESCRIPTION**

FIG. 1 is a perspective view of a display tray for packaging of odor absorbers showing the new design;  
FIG. 2 is a top view thereof;  
FIG. 3 is a bottom view thereof;  
FIG. 4 is a left side view thereof;  
FIG. 5 is a right side view thereof;  
FIG. 6 is a front view thereof; and,  
FIG. 7 is a rear view thereof.

**1 Claim, 5 Drawing Sheets**

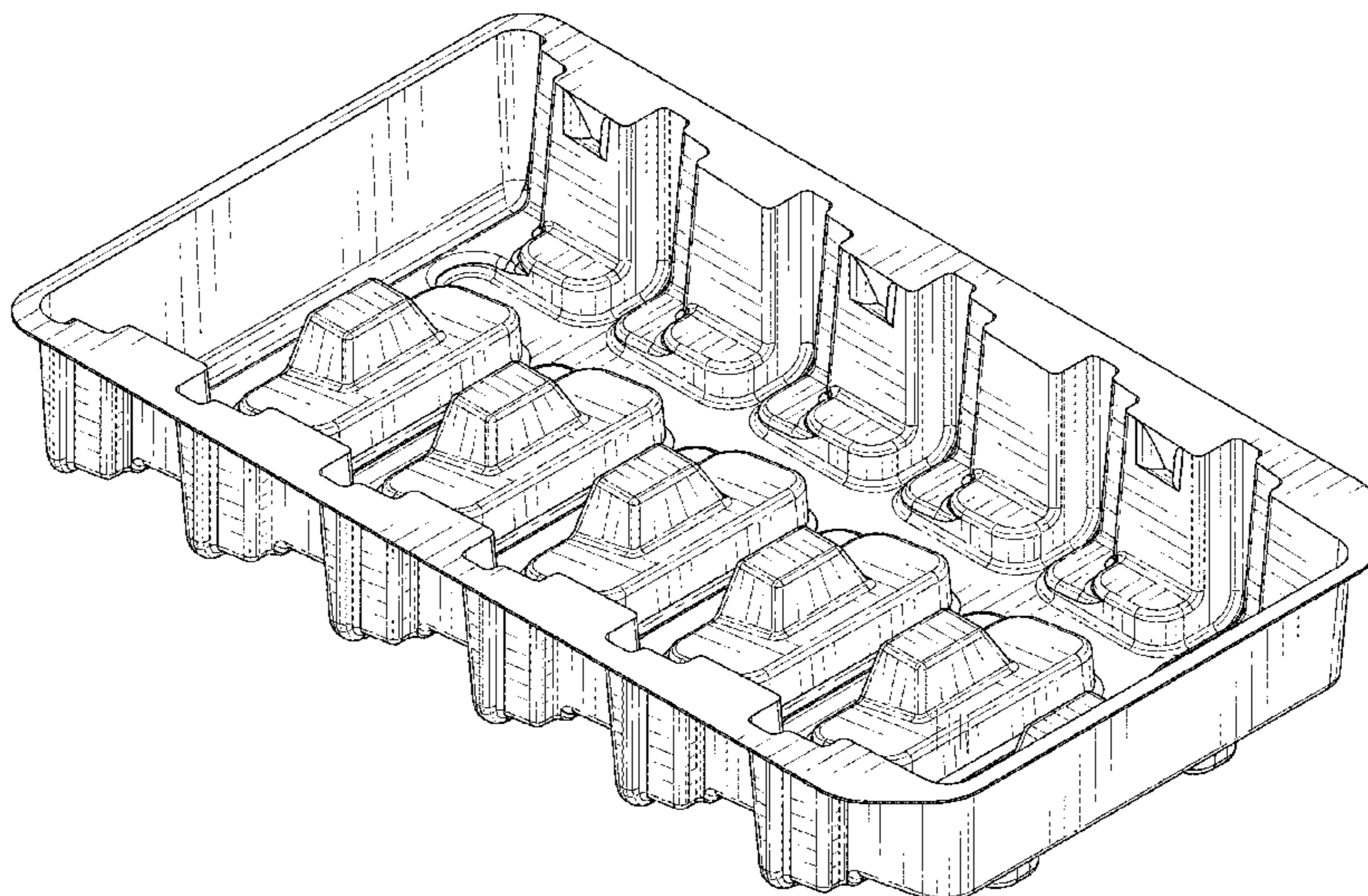

(56)

**References Cited**

U.S. PATENT DOCUMENTS

D702,126 S \* 4/2014 Marchetti ..... B65D 81/05  
D9/456  
D812,476 S \* 3/2018 Bergeron ..... D9/456  
D864,668 S \* 10/2019 Bergeron ..... D7/553.2  
D883,804 S \* 5/2020 Petrosian ..... D9/756  
D903,485 S \* 12/2020 Bontrager ..... D9/425  
D904,183 S \* 12/2020 Bontrager ..... D9/425  
D906,816 S \* 1/2021 Yu ..... D9/456  
2018/0361056 A1\* 12/2018 Horlock ..... A61M 5/002

\* cited by examiner

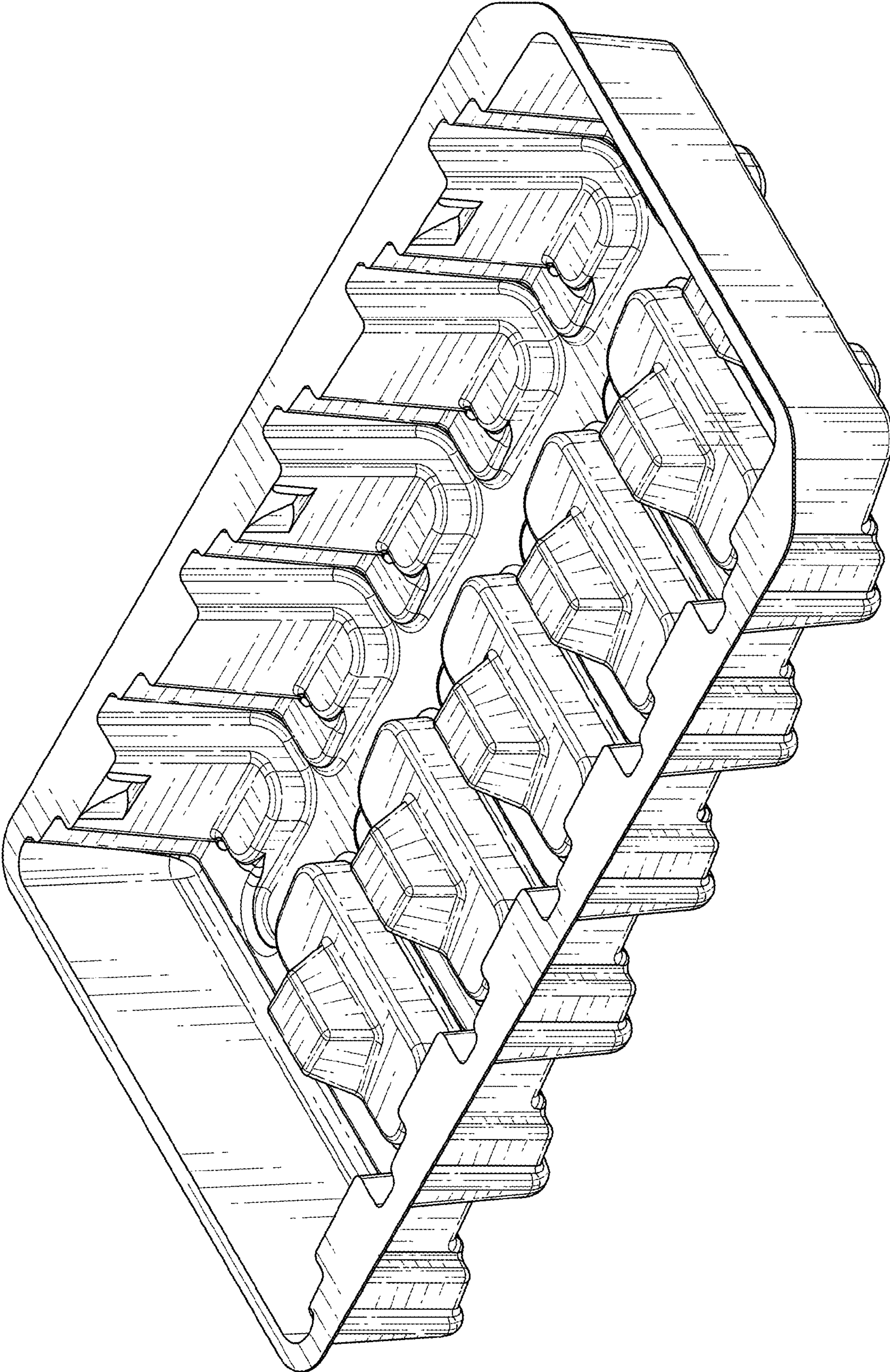

FIG. 1

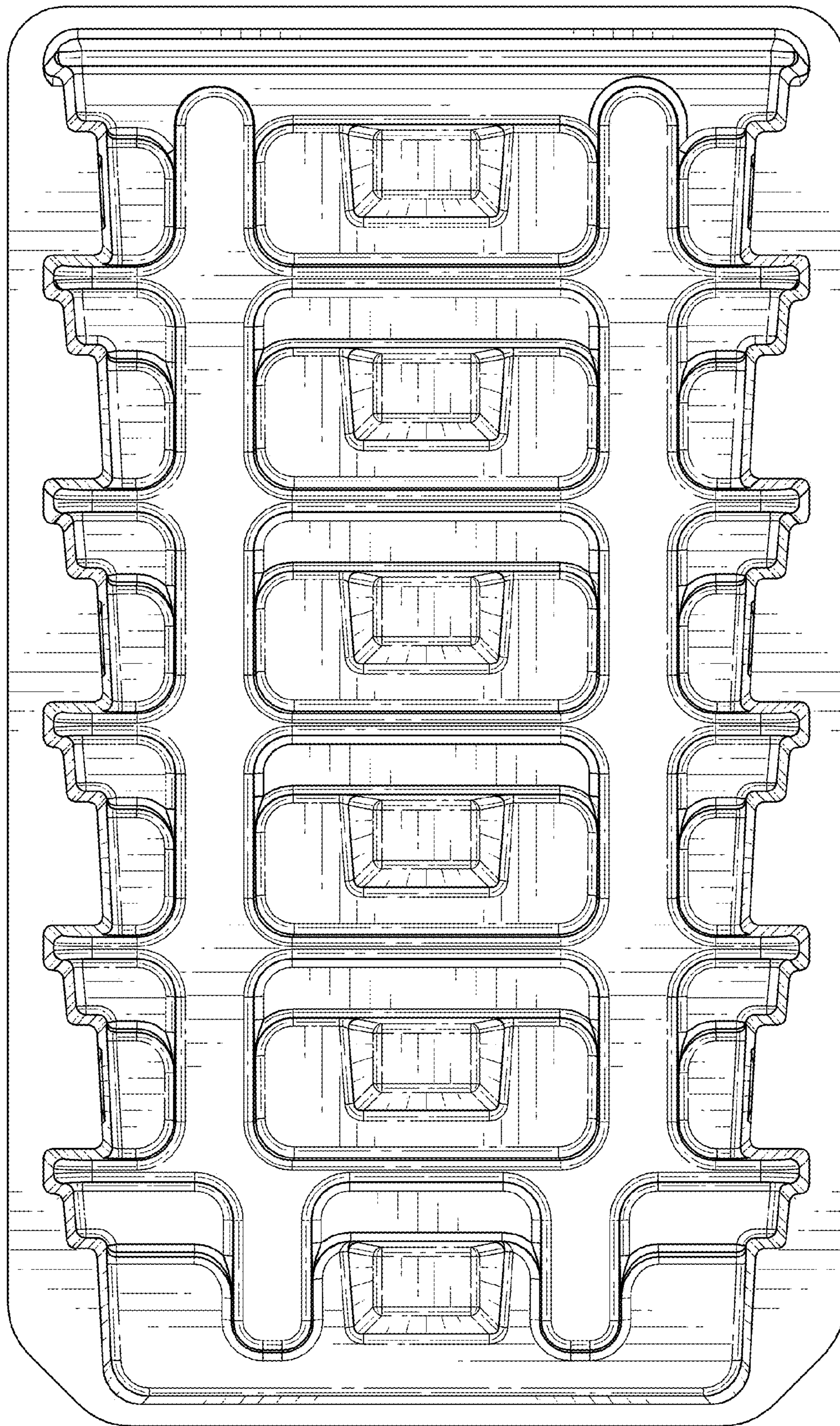

FIG. 2

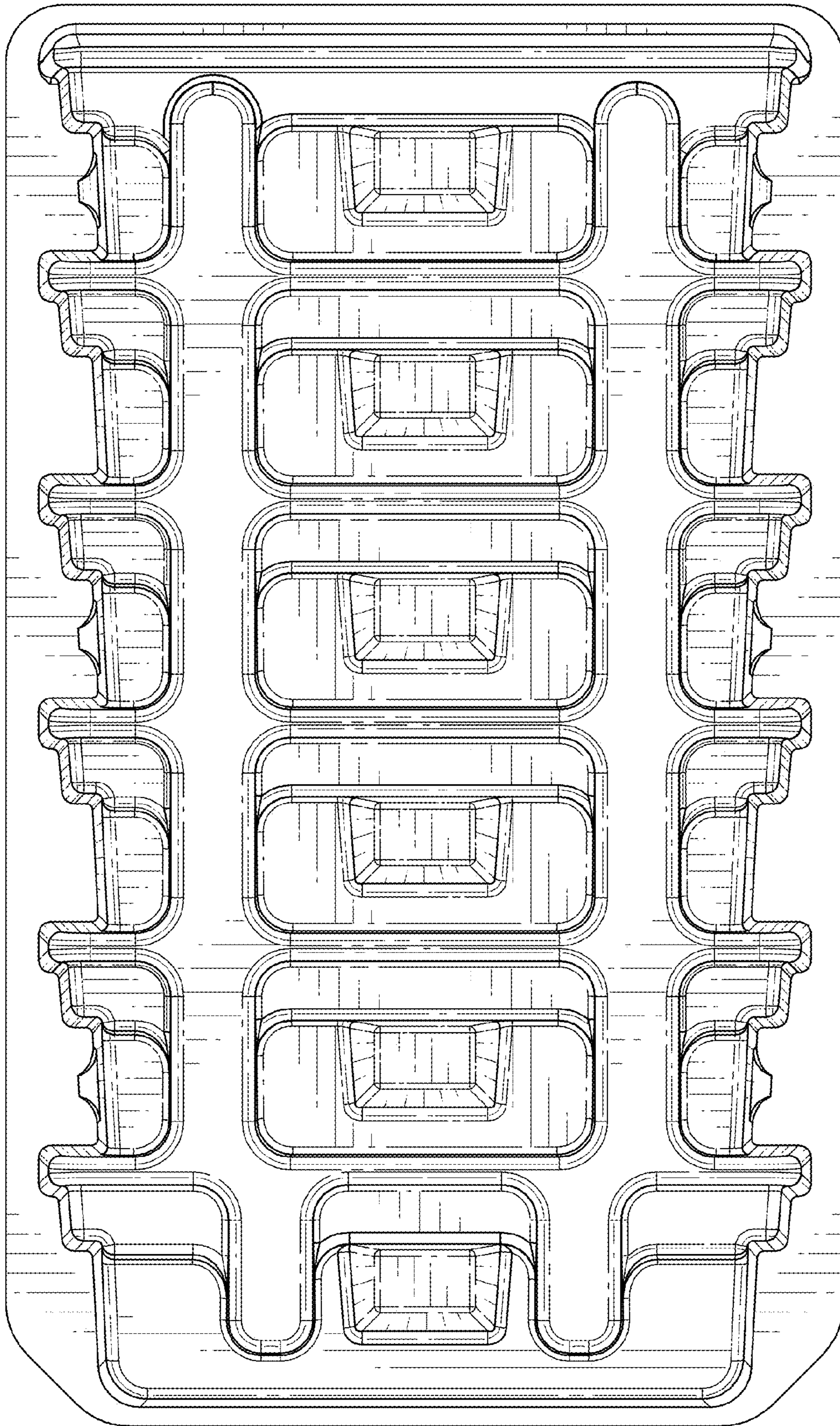

FIG. 3

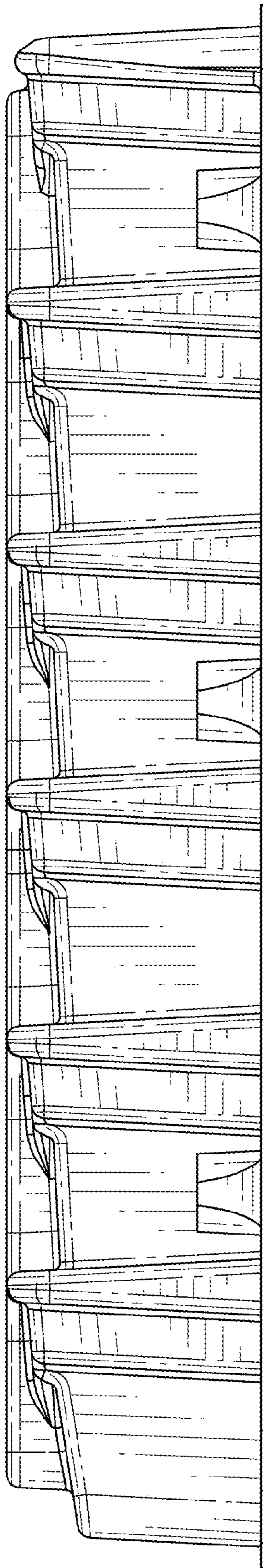

FIG. 4

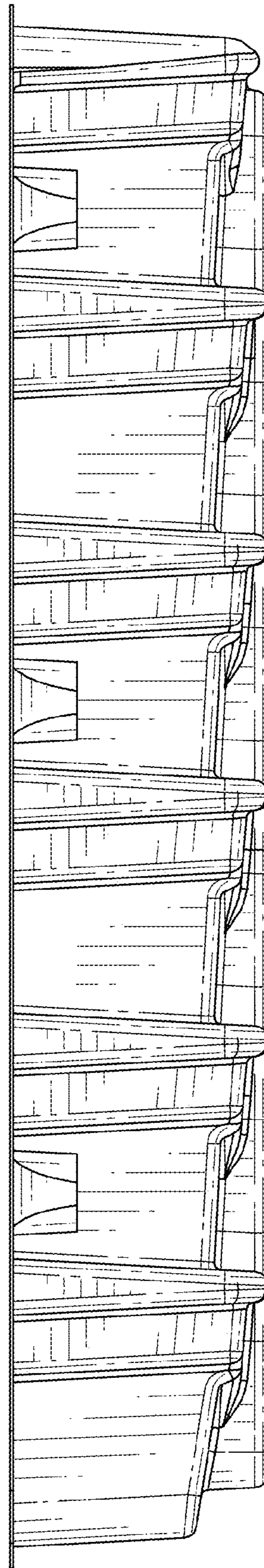

FIG. 5

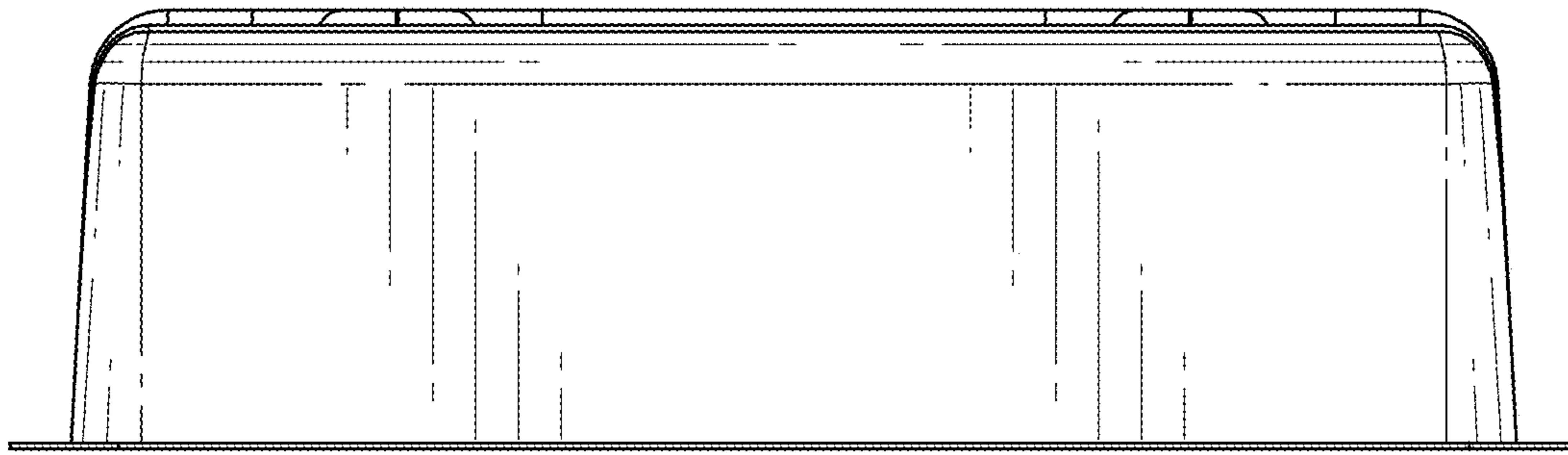

FIG. 6

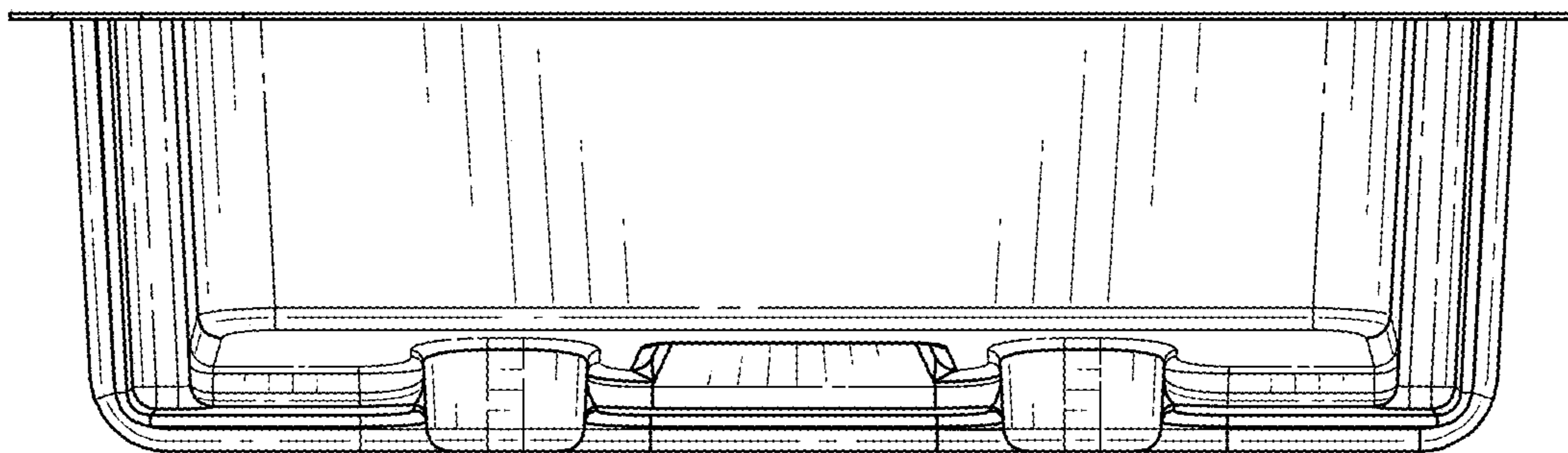

FIG. 7