



US00D928607S

(12) **United States Design Patent** (10) **Patent No.:** **US D928,607 S**
Redding et al. (45) **Date of Patent:** **** Aug. 24, 2021**

(54) **ORAL CARE PACKAGE WITH SURFACE ORNAMENTATION**

(71) Applicant: **The Procter & Gamble Company**, Cincinnati, OH (US)

(72) Inventors: **Kartika Huston Redding**, Cincinnati, OH (US); **Xiaojie Geng**, Beijing (CN); **Ming Qi**, Beijing (CN)

(73) Assignee: **The Procter & Gamble Company**, Cincinnati, OH (US)

(**) Term: **15 Years**

(21) Appl. No.: **29/726,220**

(22) Filed: **Mar. 2, 2020**

Related U.S. Application Data

(62) Division of application No. 29/647,235, filed on May 10, 2018, now Pat. No. Des. 880,293.

(30) **Foreign Application Priority Data**

Nov. 17, 2017 (CN) 201730569987.3

(51) **LOC (13) Cl.** **09-03**

(52) **U.S. Cl.**
USPC **D9/432; D9/600**

(58) **Field of Classification Search**
USPC D9/414-423, 424-429, 430-433, 434, D9/456, 457, 711, 713, 721-722, 737,
(Continued)

(56) **References Cited**

U.S. PATENT DOCUMENTS

3,389,850 A 6/1968 Rockefeller
D309,262 S 7/1990 Coiner
(Continued)

OTHER PUBLICATIONS

Crest, Oral-B and Blend-a-med Announce the Launch of Their First Ever Recyclable HDPE Toothpaste Tubes in North America and

Europe. [online] Published Dec. 2, 2020. Retrieved from URL: <https://americanstocknews.com/tag/procter-gamble/>.*

(Continued)

Primary Examiner — Vy N Koenig

(74) *Attorney, Agent, or Firm* — Parker D. McCrary;
Jason Jeffrey Camp

(57) **CLAIM**

The ornamental design for an oral care package with surface ornamentation, as shown and described.

DESCRIPTION

The file of this patent contains at least one drawing/photograph executed in color. Copies of this patent or patent application publication with color drawing(s) will be provided by the Office upon request and payment of the necessary fee.

FIG. 1 is an isometric view of a first embodiment of the oral care package with surface ornamentation, embodying the new design, wherein the color is disclaimed;

FIG. 2 is a front view thereof;

FIG. 3 is a back view thereof;

FIG. 4 is a right view thereof;

FIG. 5 is a left view thereof;

FIG. 6 is a top view thereof;

FIG. 7 is a bottom view thereof;

FIG. 8 is an isometric view of a second embodiment of the oral care package with surface ornamentation, embodying the new design;

FIG. 9 is a front view thereof;

FIG. 10 is a back view thereof;

FIG. 11 is a right view thereof;

FIG. 12 is a left view thereof;

FIG. 13 is a top view thereof;

FIG. 14 is a bottom view thereof;

FIG. 15 is an isometric view of a third embodiment of the oral care package with surface ornamentation, embodying the new design, wherein the color is disclaimed;

FIG. 16 is a front view thereof;

FIG. 17 is a back view thereof;

FIG. 18 is a right view thereof;

(Continued)

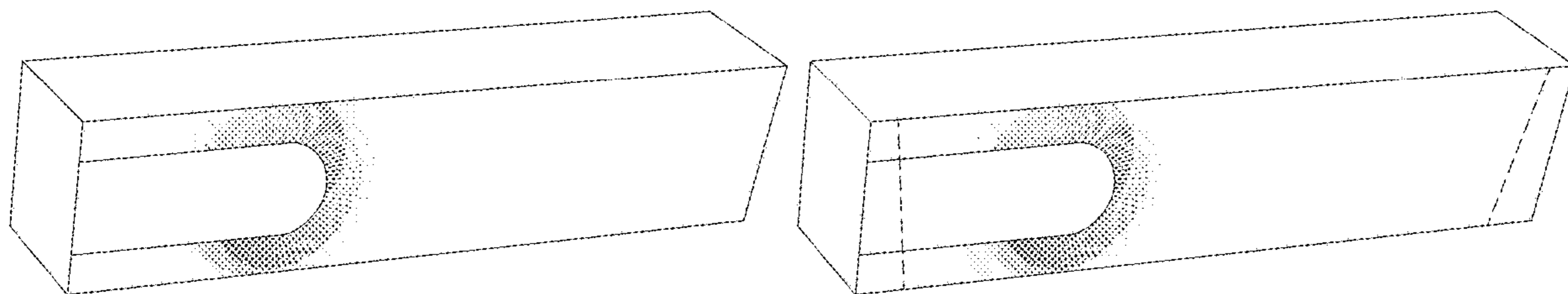

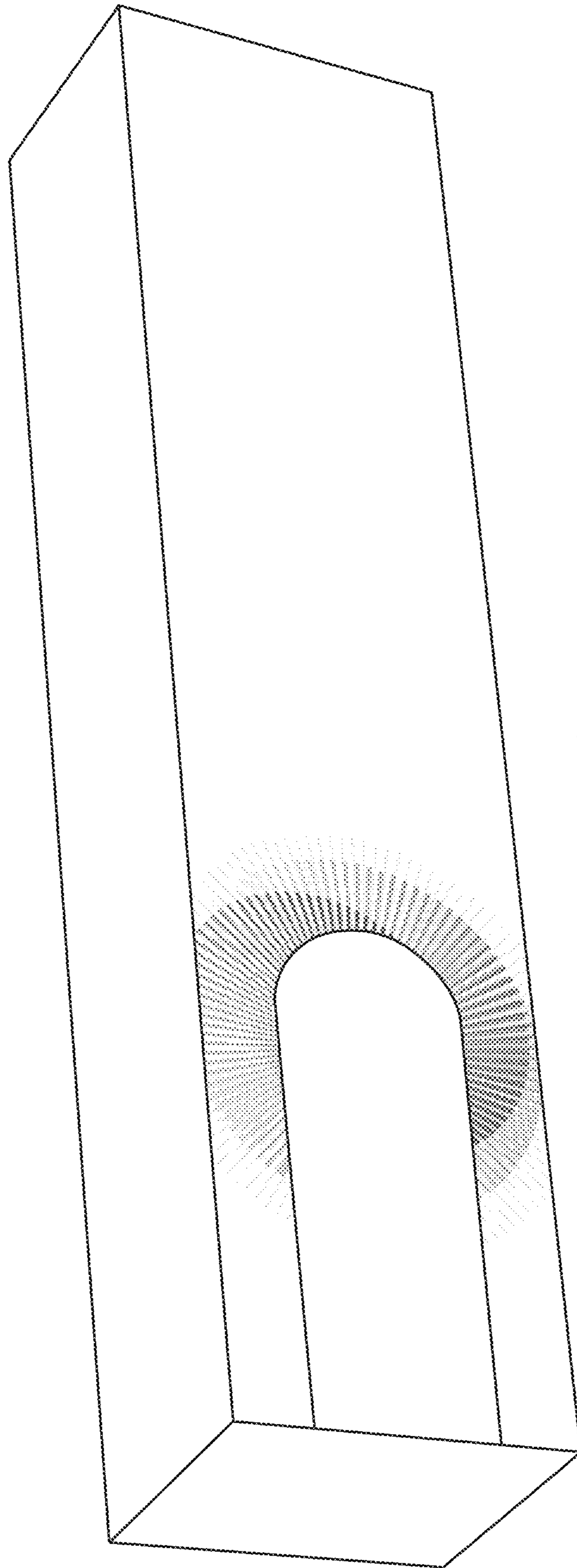

FIG. 1

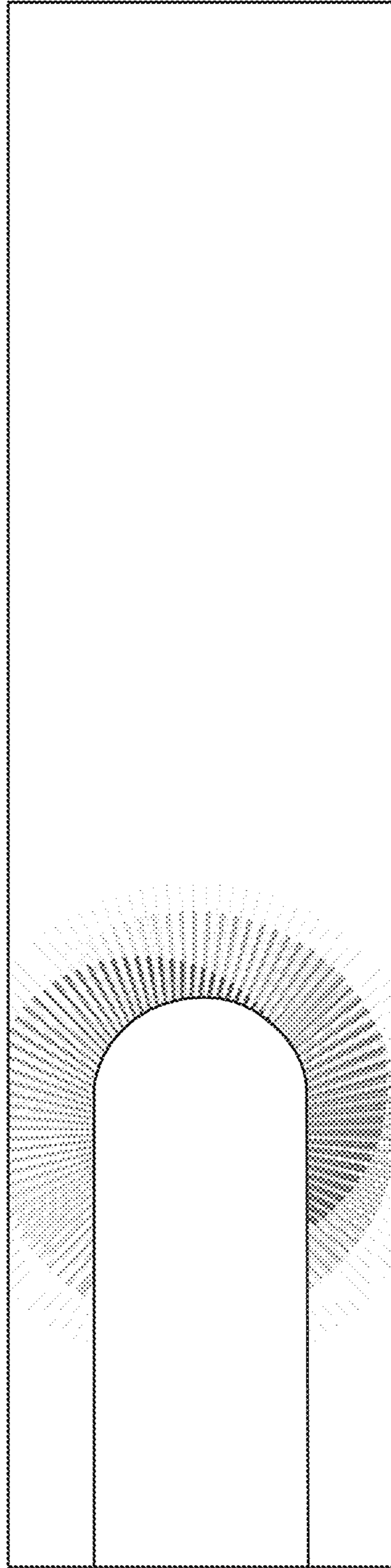

FIG. 2

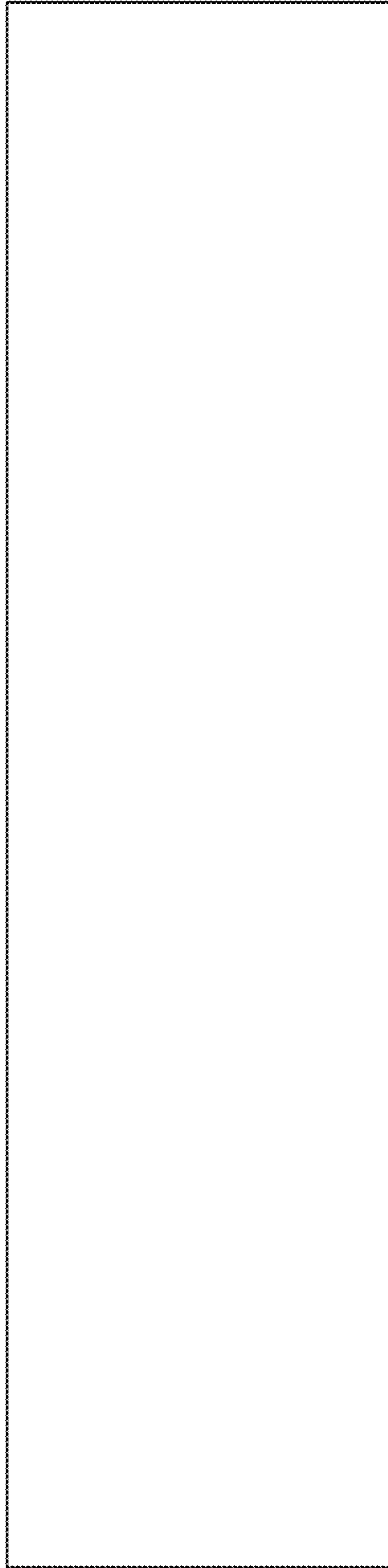

FIG. 3

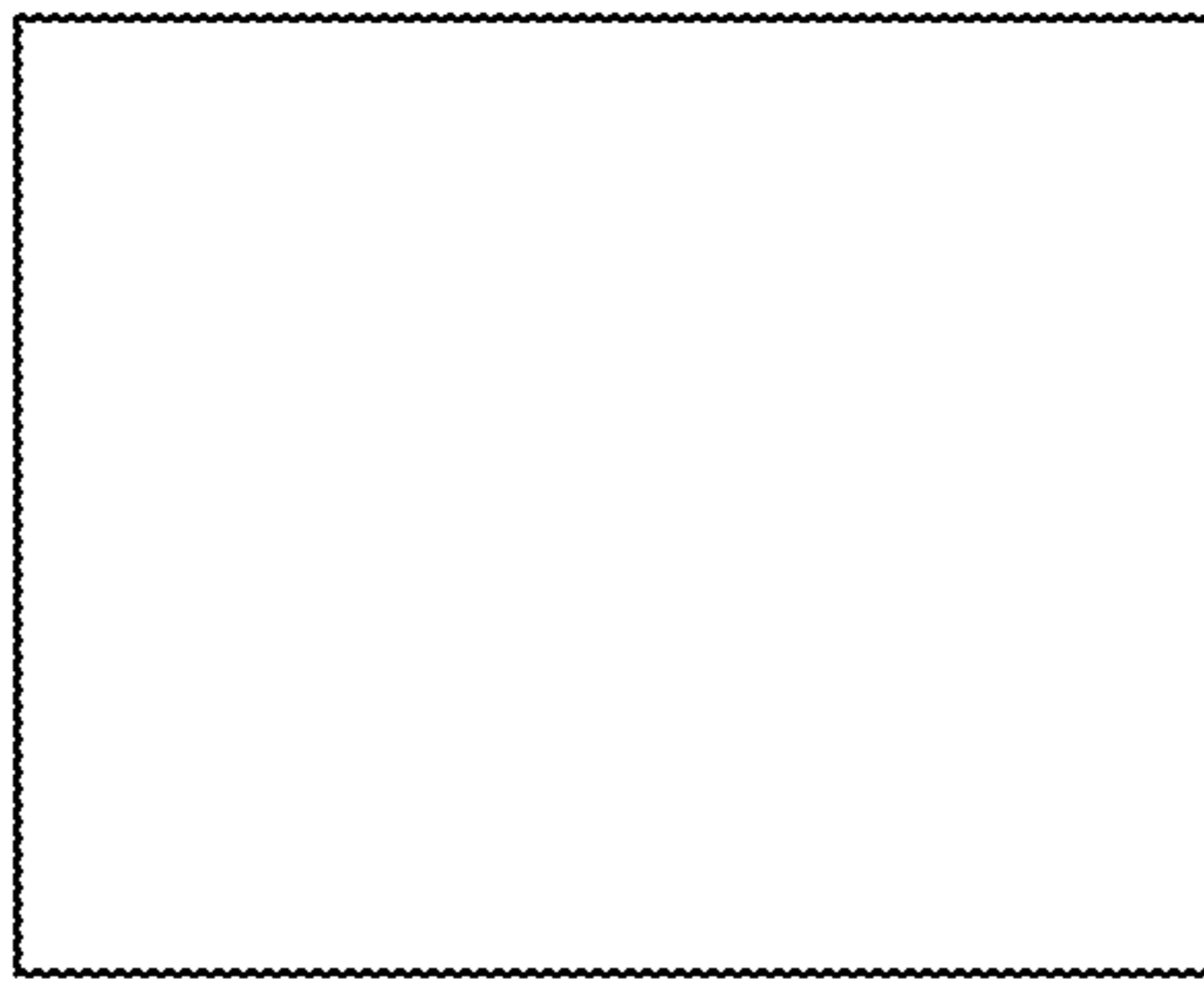

FIG. 5

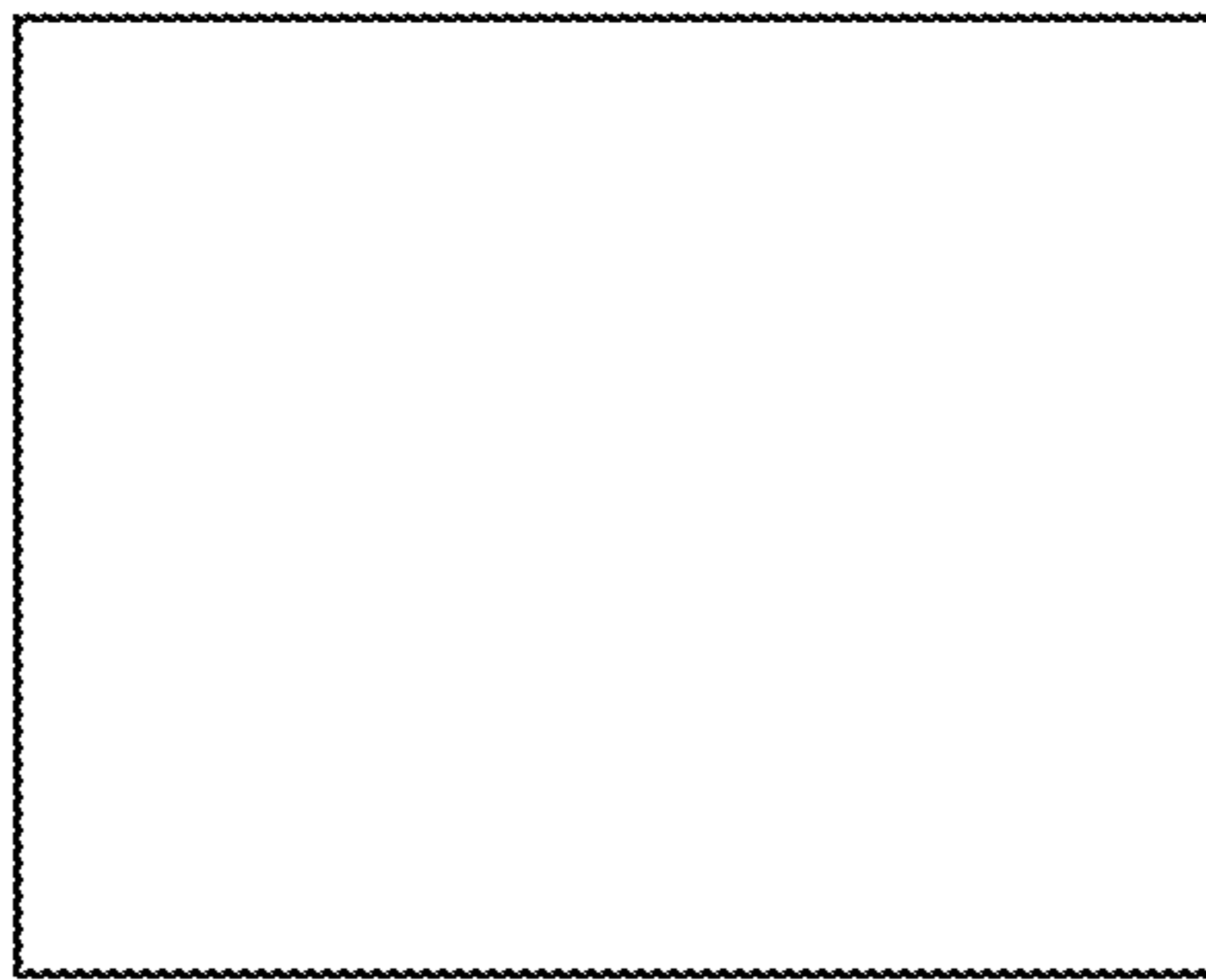

FIG. 4

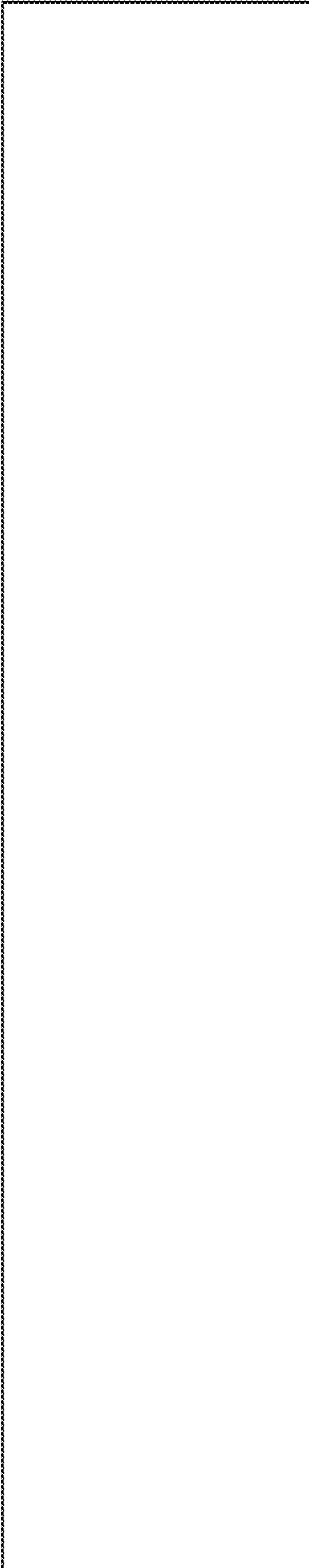

FIG. 6

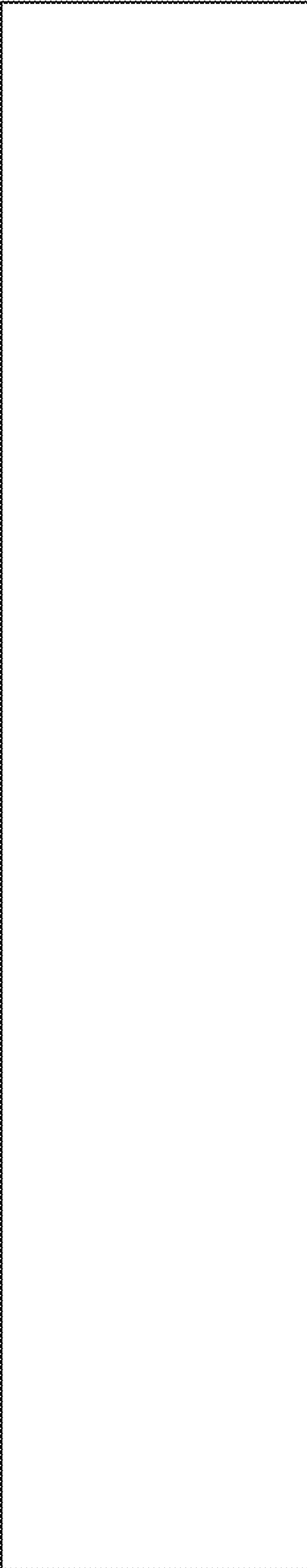

FIG. 7

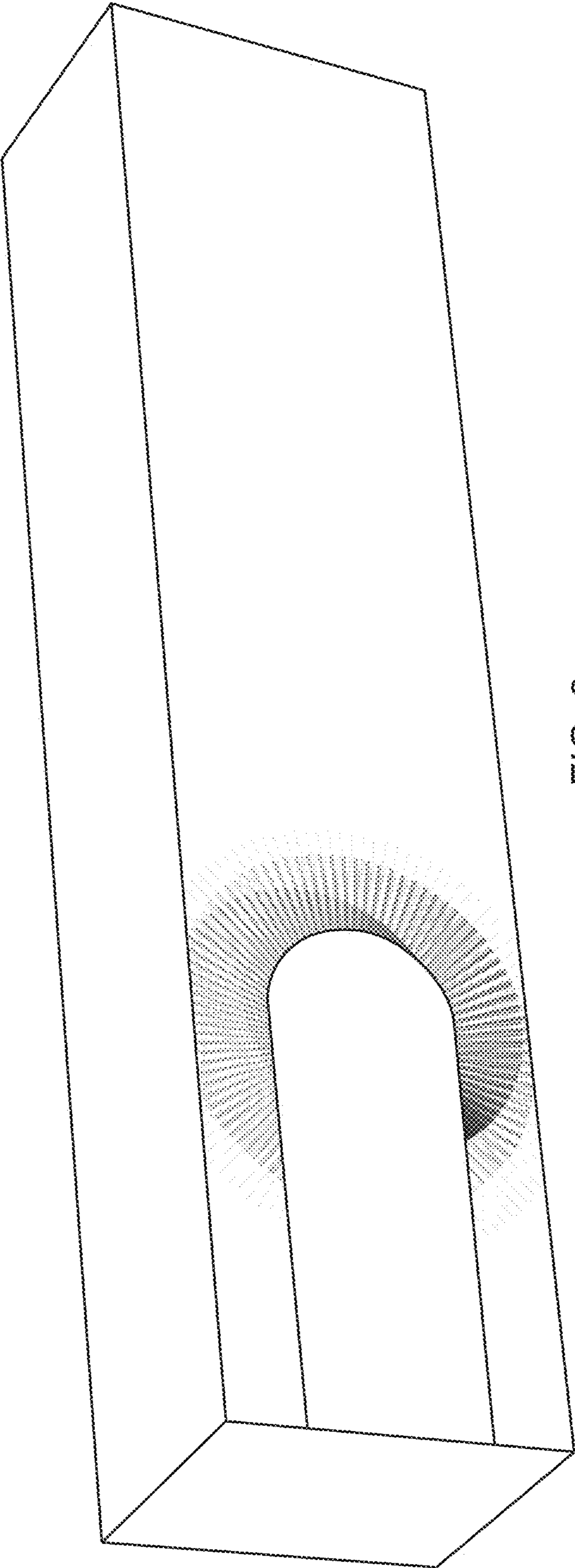

FIG. 8

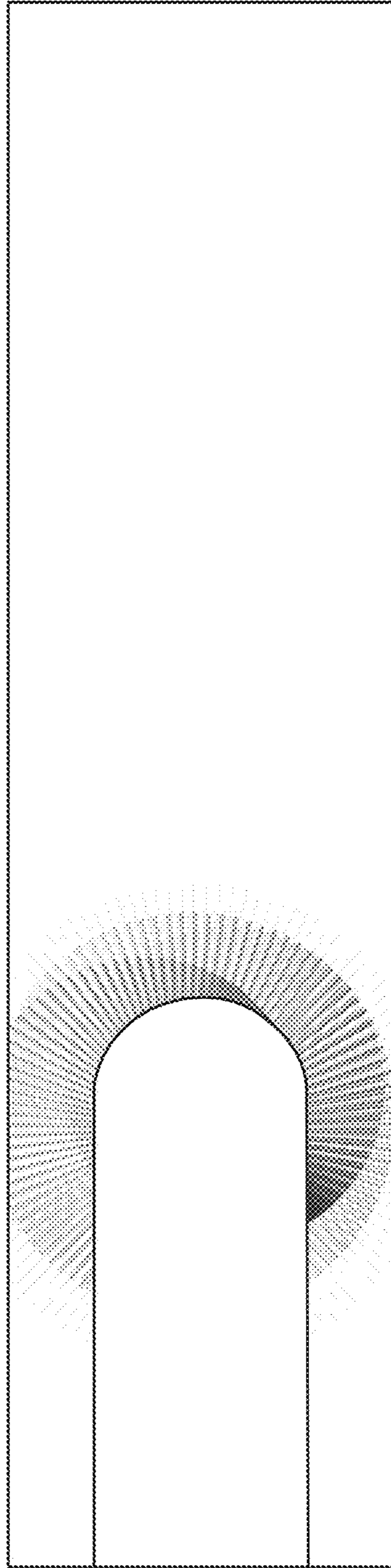

FIG. 9

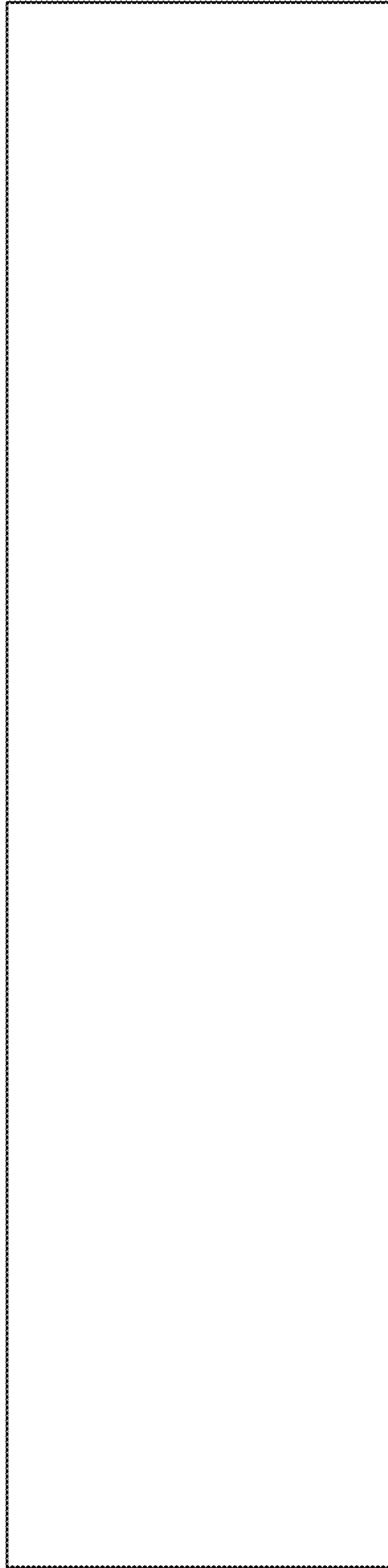

FIG. 10

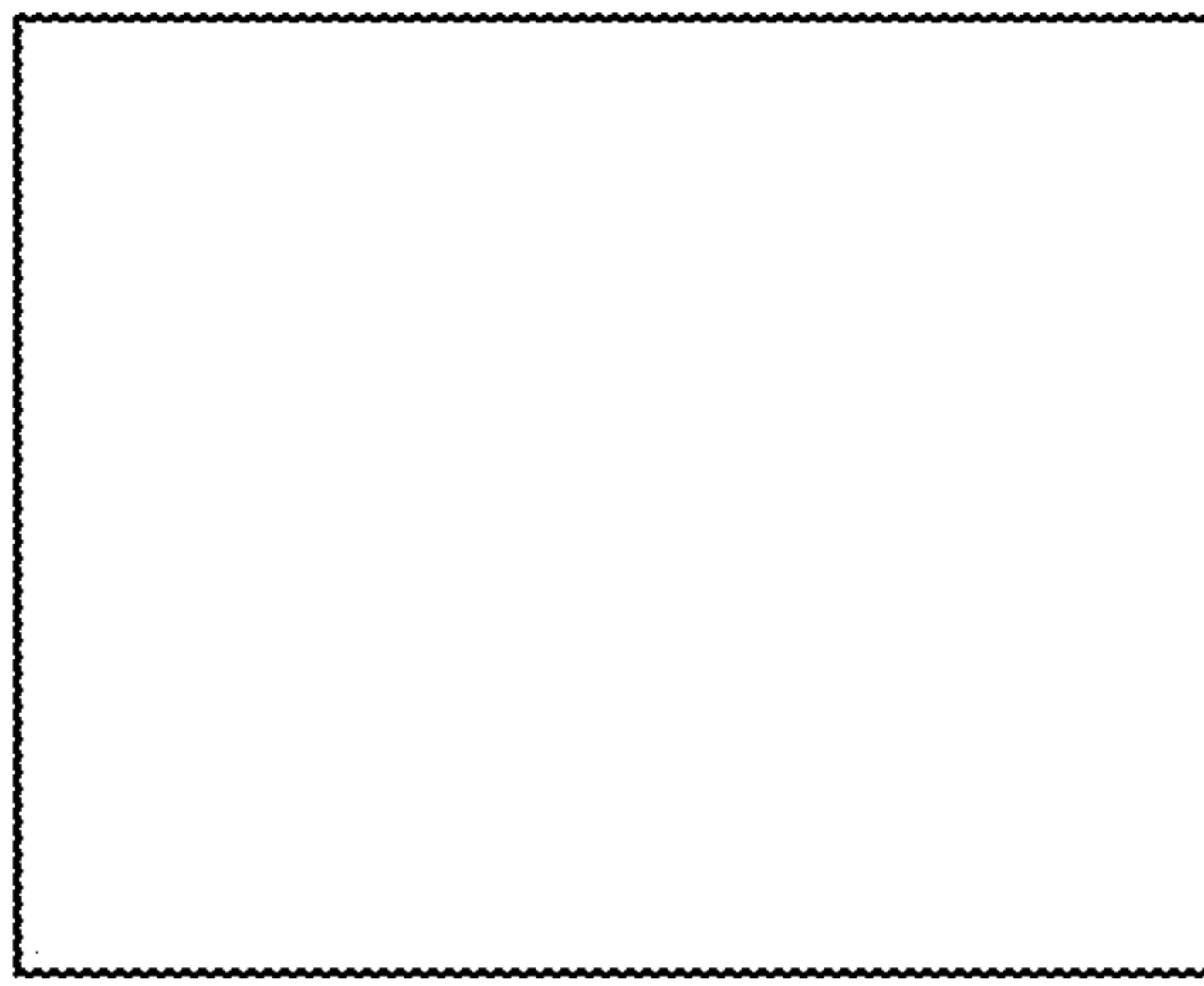

FIG. 12

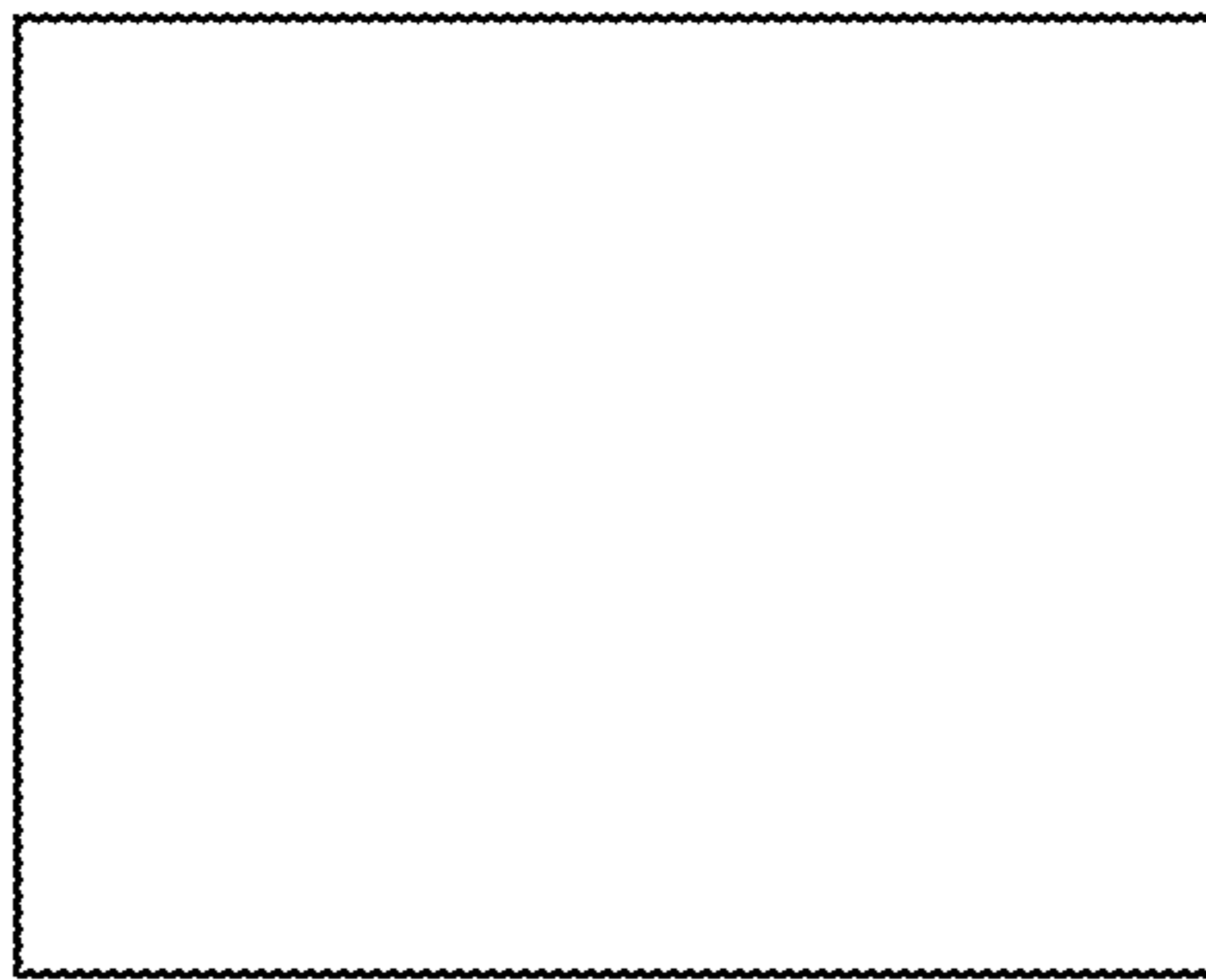

FIG. 11

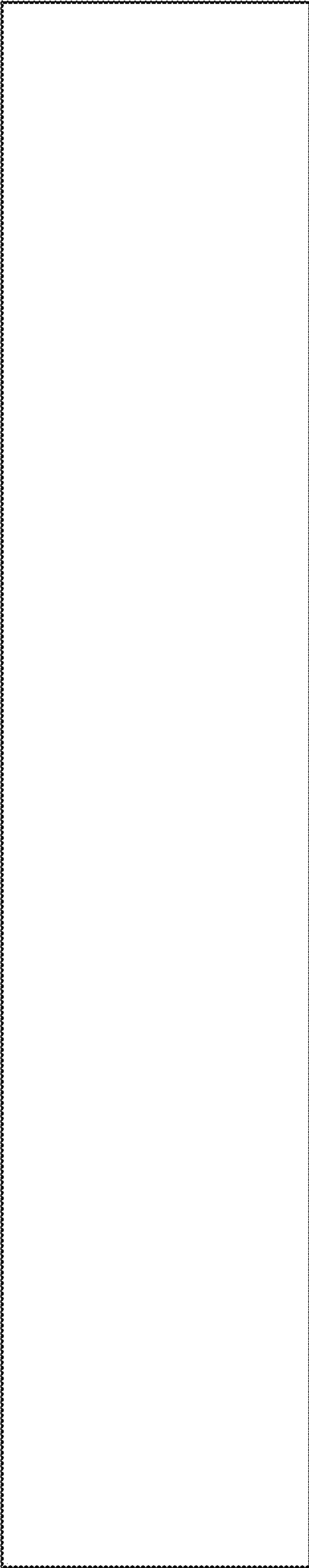

FIG. 13

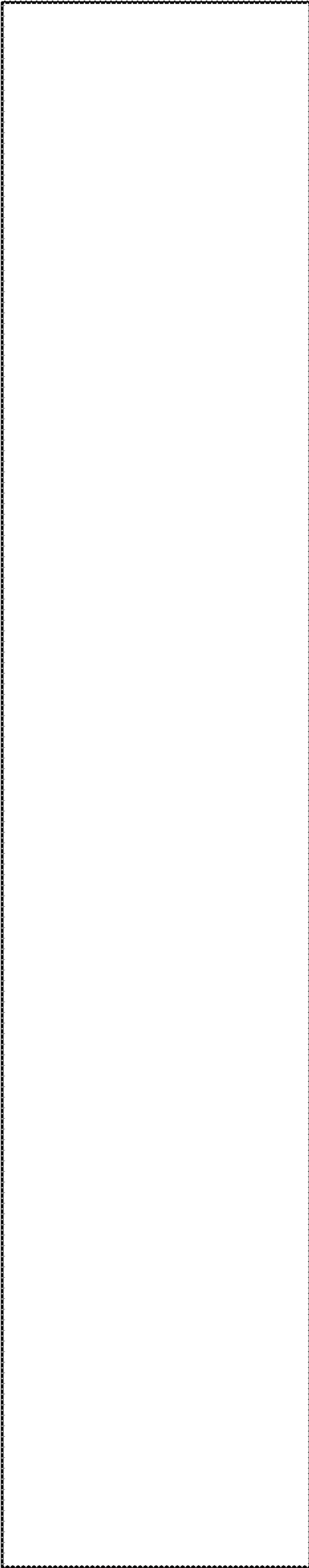

FIG. 14

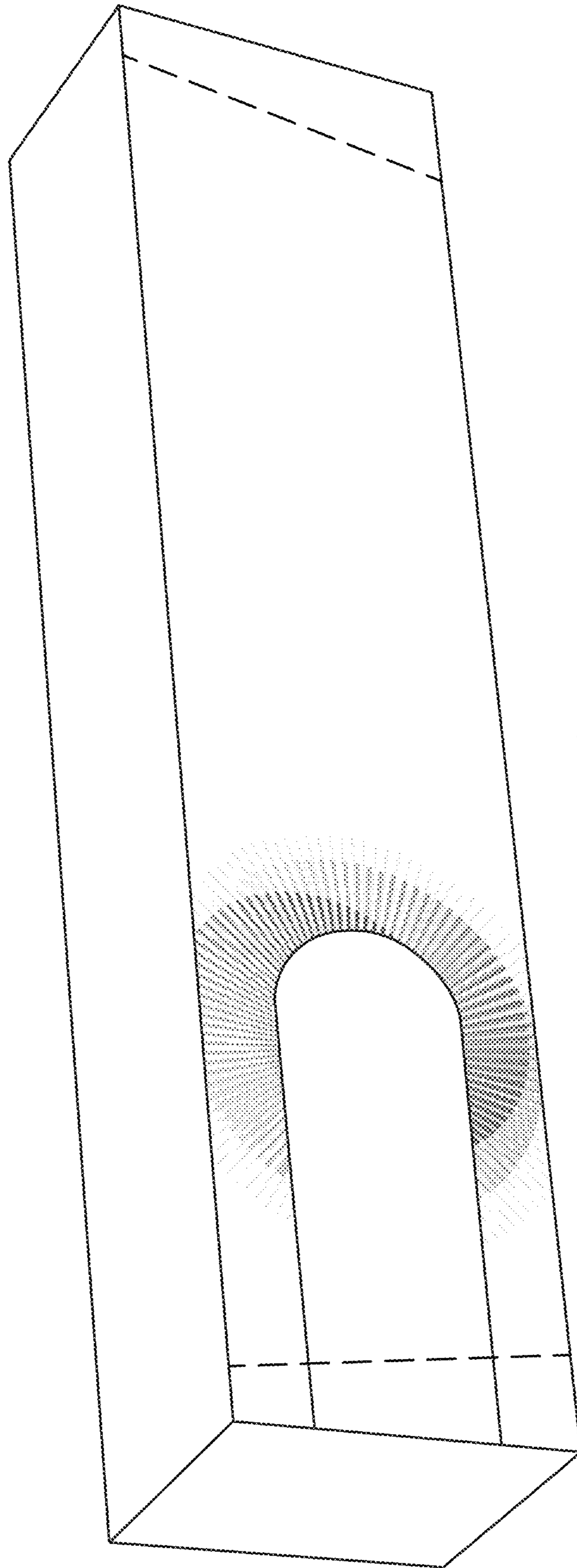

FIG. 15

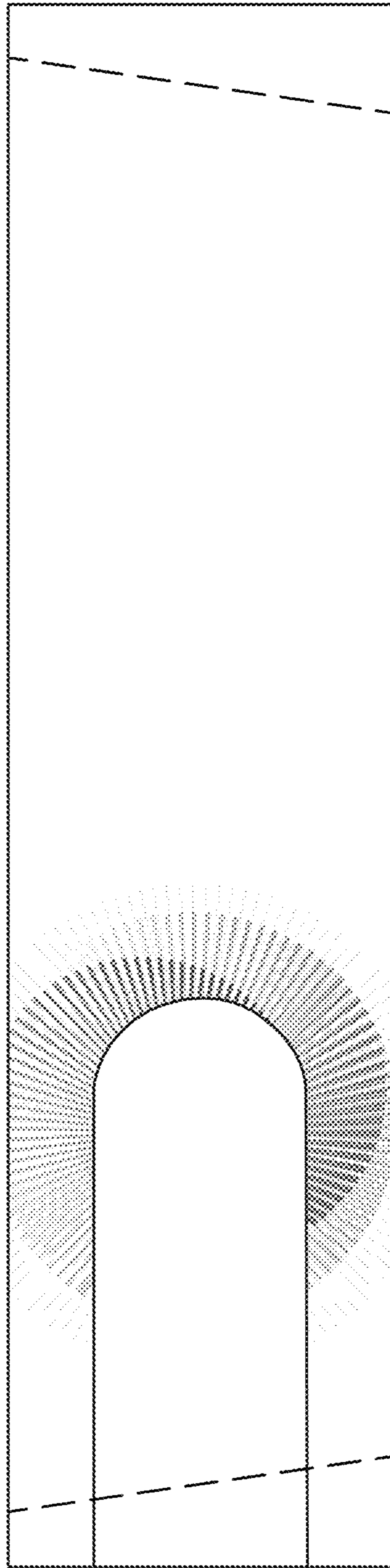

FIG. 16

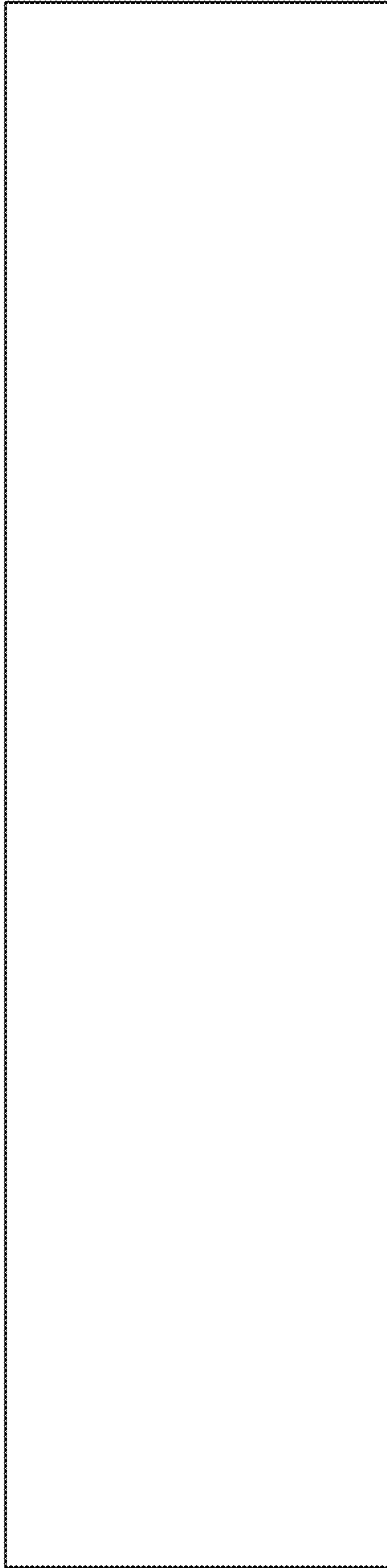

FIG. 17

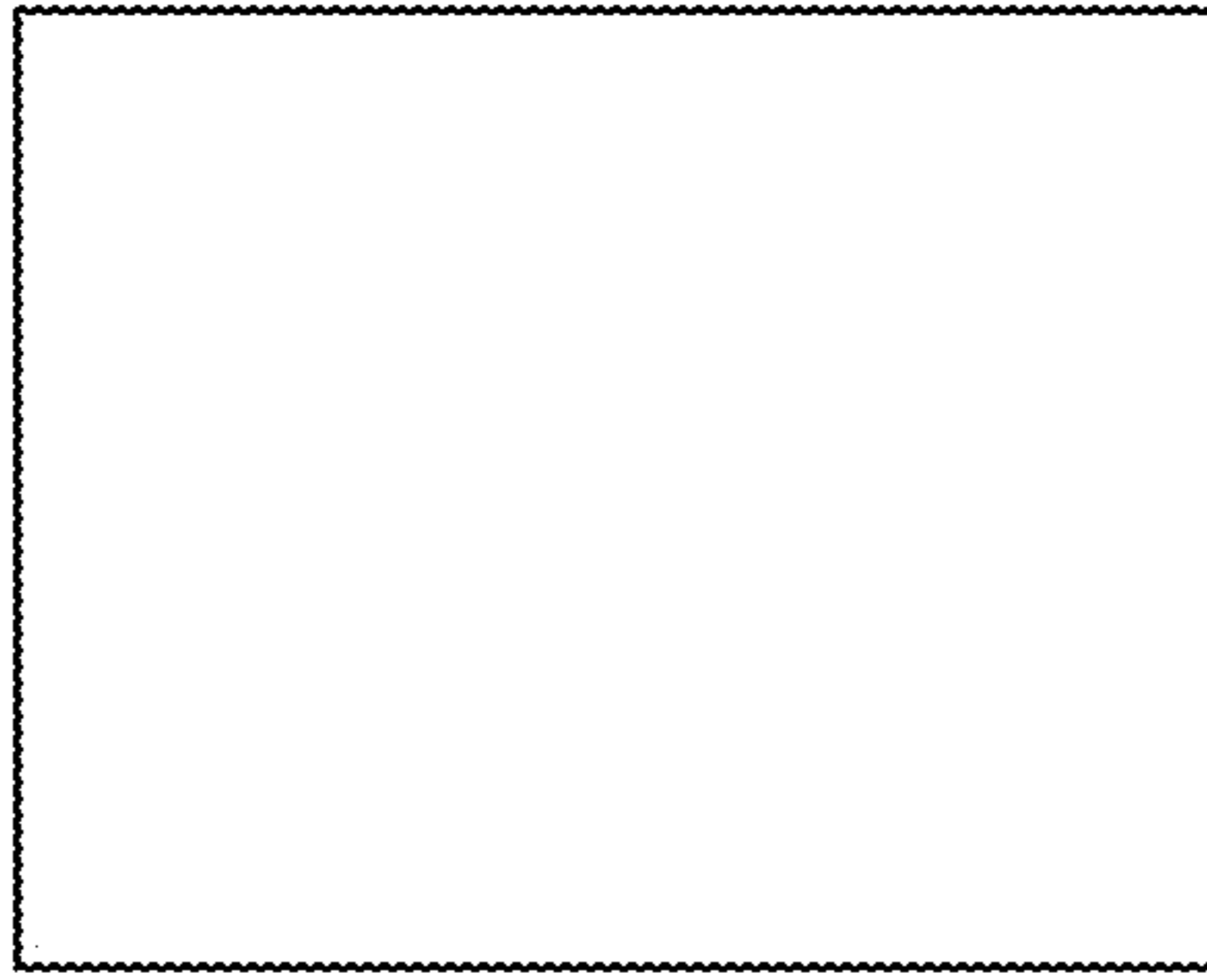

FIG. 19

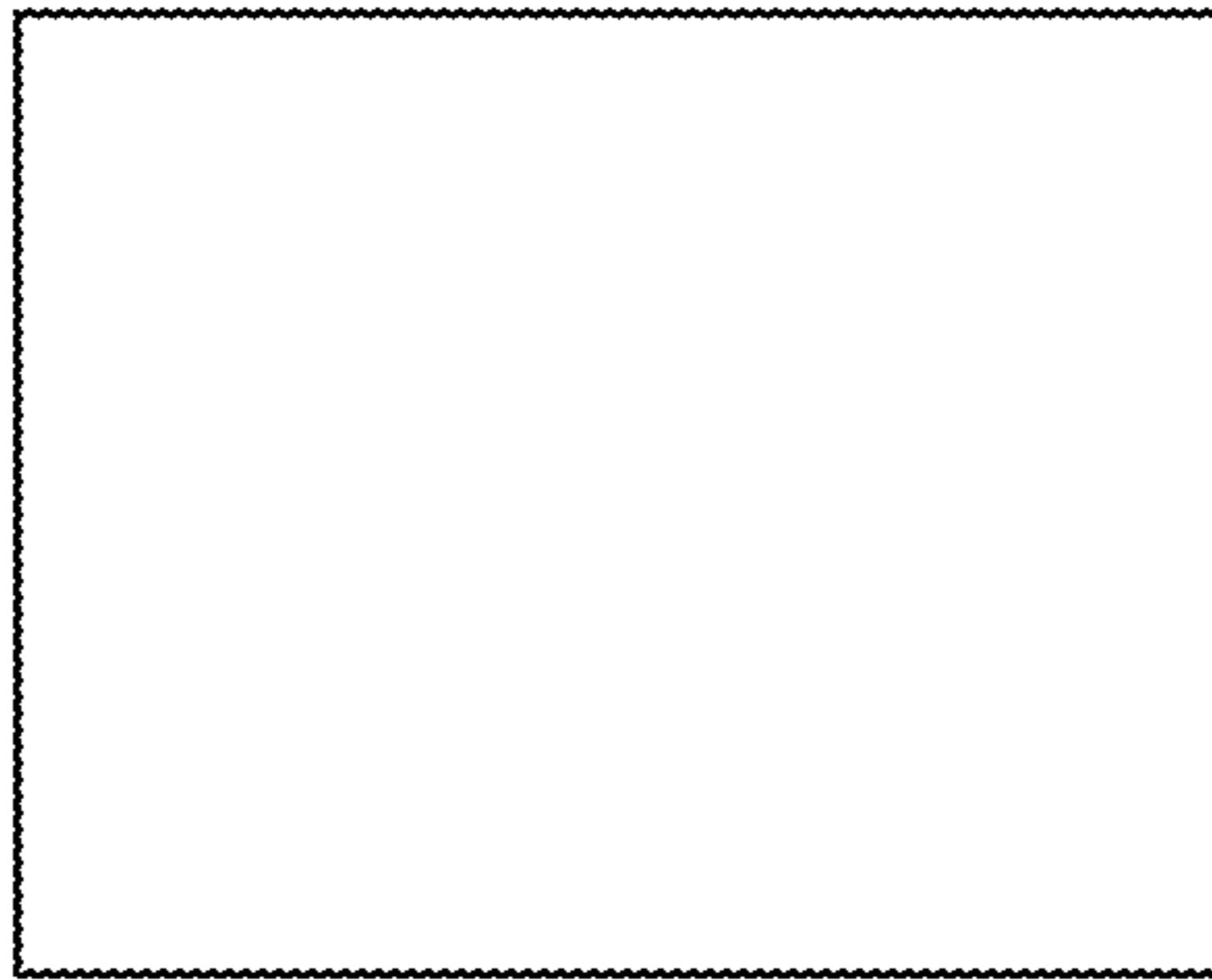

FIG. 18

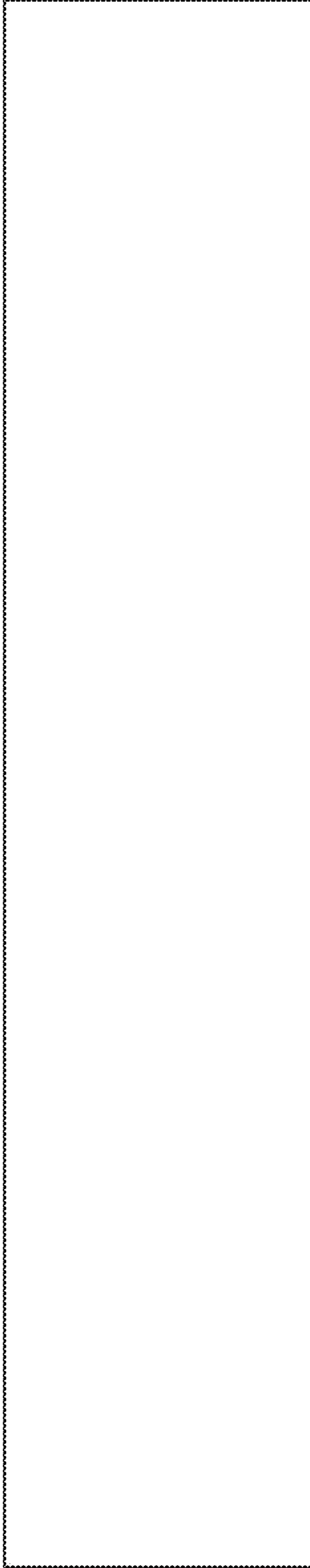

FIG. 20

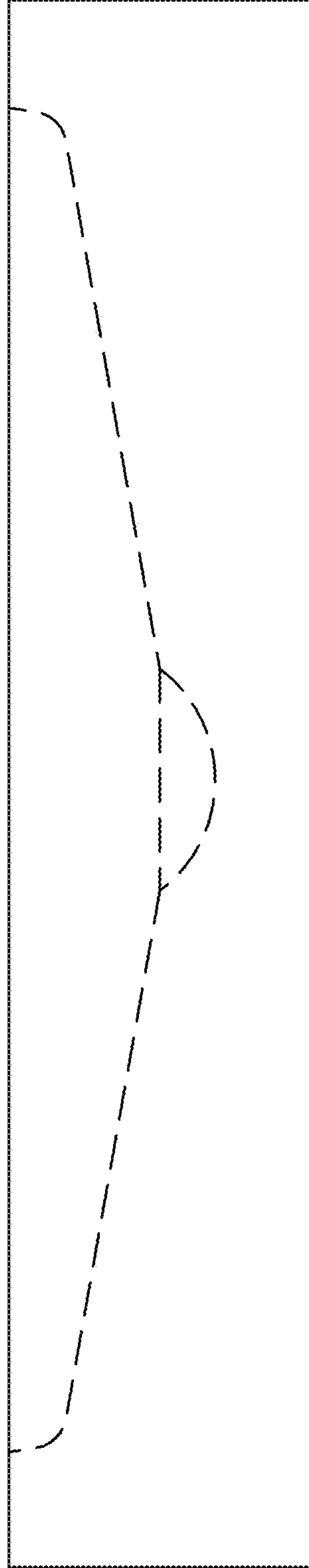

FIG. 21