



US00D928590S

(12) **United States Design Patent**  
**Zhang**

(10) **Patent No.:** **US D928,590 S**

(45) **Date of Patent:** **\*\* Aug. 24, 2021**

- (54) **VESA ADAPTER BRACKET**
- (71) Applicant: **Lexiao Zhang**, Montreal (CA)
- (72) Inventor: **Lexiao Zhang**, Montreal (CA)
- (73) Assignee: **GLADIATOR JOE INC.**, Montreal (CA)
- (\*\*) Term: **15 Years**
- (21) Appl. No.: **29/721,209**
- (22) Filed: **Jan. 18, 2020**
- (51) **LOC (13) Cl.** ..... **08-05**
- (52) **U.S. Cl.**  
USPC ..... **D8/354**
- (58) **Field of Classification Search**  
USPC ..... D8/354, 349, 353, 373, 382; D20/42;  
D6/320; D15/28; D25/68; D13/152,  
D13/156  
CPC .... H01R 13/6675; H01R 13/73; H01R 24/62;  
H01R 12/716; F16B 45/00; F16M 13/02;  
H02J 7/0045  
See application file for complete search history.

(56) **References Cited**

**U.S. PATENT DOCUMENTS**

- D378,749 S \* 4/1997 Miller ..... D12/223
- 5,810,303 A \* 9/1998 Bourassa ..... H02G 3/126  
174/58
- D558,560 S \* 1/2008 Ciungan ..... D14/452
- D560,674 S \* 1/2008 Wohlford ..... D14/451
- D560,677 S \* 1/2008 Wohlford ..... D14/451
- D576,633 S \* 9/2008 Muday ..... D14/452
- D651,256 S \* 12/2011 Garfinkle ..... D20/43
- D667,249 S \* 9/2012 London ..... D6/553
- 8,387,321 B2 \* 3/2013 diGirolamo ..... E04B 2/58  
52/242
- 8,511,032 B2 \* 8/2013 Abdel-Rahman ..... E04B 2/88  
52/655.1
- RE44,740 E \* 2/2014 Ciungan ..... D8/363

- D711,213 S \* 8/2014 Schorn ..... D8/373
- D732,373 S \* 6/2015 Wagner ..... D8/349
- D737,797 S \* 9/2015 Roggenkamp ..... D14/205
- D760,066 S \* 6/2016 Krenek ..... D8/354
- D769,024 S \* 10/2016 Montoya ..... D6/567
- 9,650,780 B2 \* 5/2017 Tan ..... E04B 1/40
- D822,453 S 7/2018 Kanter
- D822,454 S 7/2018 Kanter
- D823,094 S 7/2018 Kanter
- D823,286 S 7/2018 Kanter
- D829,531 S 10/2018 Kanter
- D832,970 S \* 11/2018 Jen ..... D22/108
- D833,851 S 11/2018 Kanter
- D846,369 S 4/2019 Ni

(Continued)

**OTHER PUBLICATIONS**

US Trademark Registration No. 4825669; Word Mark—Gladiator Joe Registration date: Oct. 6, 2015 Publication date: Jul. 21, 2015.

(Continued)

*Primary Examiner* — Catherine S Posthauer  
*Assistant Examiner* — Riah D Buchanan  
(74) *Attorney, Agent, or Firm* — Legalforce RAPC  
Worldwide

(57) **CLAIM**

The ornamental design for a VESA adapter bracket, as shown and described.

**DESCRIPTION**

FIG. 1 is a front top right side perspective view for a VESA adapter bracket, showing my new design;  
FIG. 2 is a front elevational view of FIG. 1 thereof;  
FIG. 3 is a rear elevational view of FIG. 1 thereof;  
FIG. 4 is a left side elevational view of FIG. 1 thereof, the right side elevational view being a mirror image;  
FIG. 5 is a top plan view of FIG. 1 thereof; and,  
FIG. 6 is a bottom plan view of FIG. 1 thereof.

**1 Claim, 6 Drawing Sheets**

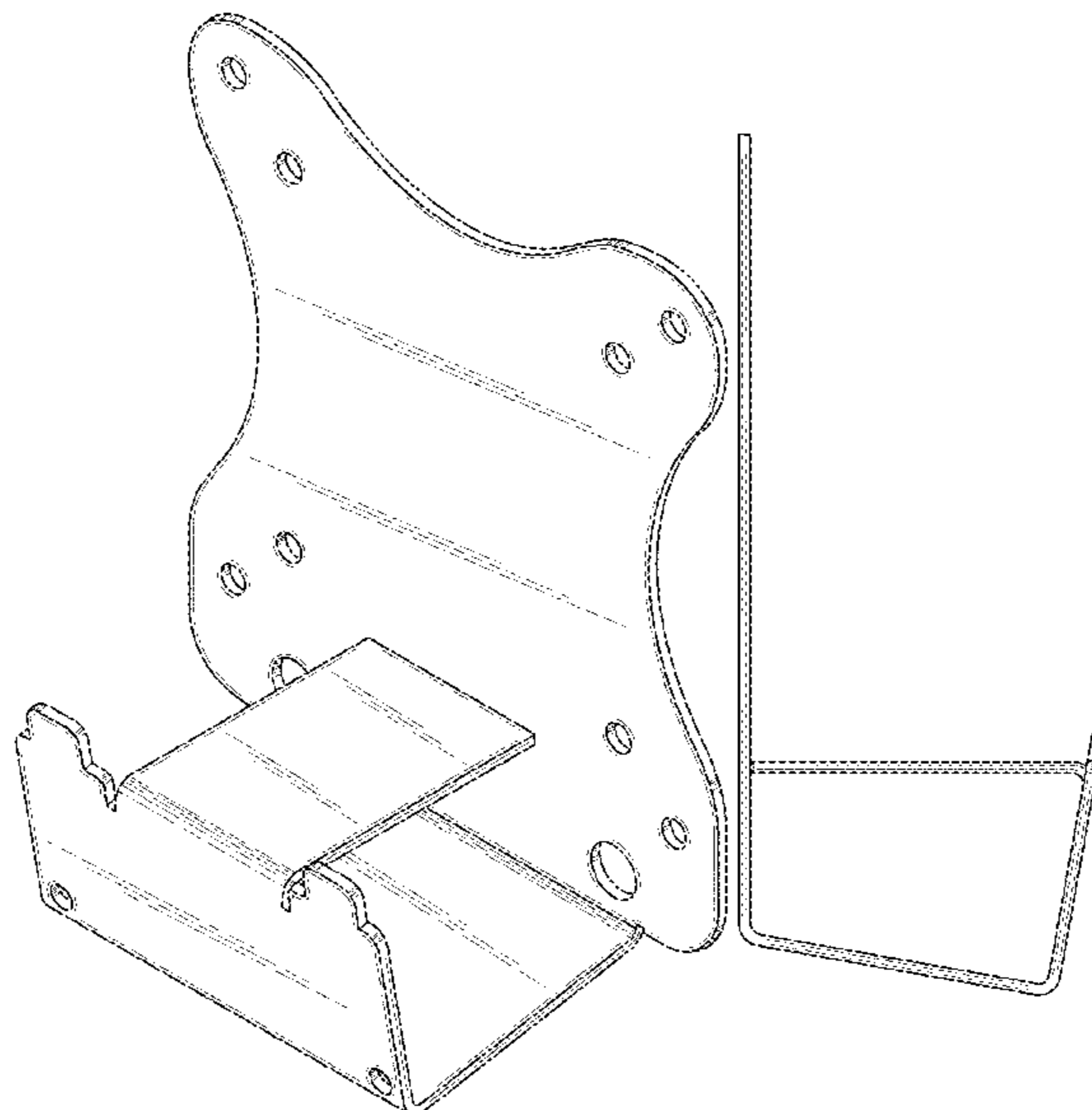

(56)

References Cited

U.S. PATENT DOCUMENTS

D846,370	S		4/2019	Ni	
D851,196	S	*	6/2019	Chester	D22/108
D859,958	S		9/2019	Ni	
D863,040	S	*	10/2019	DeDios-Shirley	D8/354
D867,120	S	*	11/2019	Moreau	D8/394
D886,569	S	*	6/2020	Vlad	D8/354
D891,231	S	*	7/2020	Gilner	D8/354
D891,232	S	*	7/2020	Zhang	D8/354
D892,597	S	*	8/2020	Stoops	D8/354
D894,717	S	*	9/2020	Fehr	D8/354
D894,879	S	*	9/2020	Fehr	D14/238
D899,897	S	*	10/2020	Gustafsson Salmonsson	D8/354
D906,095	S	*	12/2020	DeDios-Shirley	D8/354
D910,393	S	*	2/2021	Wyatt	D8/31
D912,497	S	*	3/2021	Herbertsson	D8/354
D913,077	S	*	3/2021	Pavlov	D8/349
D913,078	S	*	3/2021	Pavlov	D8/349
D913,288	S	*	3/2021	Fehr	D14/432
D913,779	S	*	3/2021	Murphy	D8/381
D918,019	S	*	5/2021	Foley	D8/354
2012/0025046	A1	*	2/2012	Yen	F16M 11/045 248/298.1

OTHER PUBLICATIONS

US Trademark Registration No. 4825790; Word Mark—GJ Registration date: Oct. 6, 2015 Publication date: Jul. 21, 2015.

US Trademark Registration No. 5298001; Word Mark—I Am Gladiator I Am Victorious Registration date: Sep. 26, 2017 Publication date: Jan. 24, 2017.

“Samsung Monitor VESA Adapter Bracket—GJ0A0052-R2” by Gladiator Joe, Published Online on [Sep. 20, 2018] [https://gladiatorjoe.com/wp-content/uploads/2017/10/gladiatorjoe\\_monitor\\_vesa\\_adapter\\_GJ0A0052-R2\\_WEBSITE-300x300.jpg](https://gladiatorjoe.com/wp-content/uploads/2017/10/gladiatorjoe_monitor_vesa_adapter_GJ0A0052-R2_WEBSITE-300x300.jpg).

“Dell Monitor VESA Adapter Bracket—GJ0A0039-R2” by Gladiator Joe, Found Online on [Dec. 11, 2016] <https://gladiatorjoe.com/>

[wp-content/uploads/2017/11/gladiatorjoe\\_monitor\\_vesa\\_adapter\\_GJ0A0039-R2\\_SHADOW-300x300.jpg](https://gladiatorjoe.com/wp-content/uploads/2017/11/gladiatorjoe_monitor_vesa_adapter_GJ0A0039-R2_SHADOW-300x300.jpg).

“Monitor Arm/Mount VESA Bracket Adapter Compatible with Acer” by Gladiator Joe, Published Online on [Oct. 31, 2018] [https://images-na.ssl-images-amazon.com/images/I/91g6oRiwKCL.\\_AC\\_SL1500\\_.jpg](https://images-na.ssl-images-amazon.com/images/I/91g6oRiwKCL._AC_SL1500_.jpg).

“Acer Monitor VESA Adapter Bracket” by Gladiator Joe, Published Online on [Oct. 4, 2016] [https://gladiatorjoe.com/wp-content/uploads/2017/11/gladiatorjoe\\_monitor\\_vesa\\_adapter\\_GJ0A0032-R2\\_SHADOW.jpg](https://gladiatorjoe.com/wp-content/uploads/2017/11/gladiatorjoe_monitor_vesa_adapter_GJ0A0032-R2_SHADOW.jpg).

“Monitor Arm/Mount VESA Bracket Adapter Wall Mount” by Gladiator Joe, Published Online on [Sep. 8, 2017] [https://images-na.ssl-images-amazon.com/images/I/81glaZKpJQL.\\_AC\\_SL1500\\_.jpg](https://images-na.ssl-images-amazon.com/images/I/81glaZKpJQL._AC_SL1500_.jpg).

“Monitor Arm/Mount VESA Bracket Adapter” by Gladiator Joe, Published Online on [Oct. 13, 2017] [https://images-na.ssl-images-amazon.com/images/I/71pJaBvHY5L.\\_SL1500\\_.jpg](https://images-na.ssl-images-amazon.com/images/I/71pJaBvHY5L._SL1500_.jpg).

“HP Pavilion Monitor VESA Adapter Bracket GJ0A0005-R0” by Gladiator Joe, Published Online on [Aug. 11, 2015] [https://gladiatorjoe.com/wp-content/uploads/2018/12/gladiatorjoe\\_monitor\\_vesa\\_adapter\\_GJ0A0005-R0\\_WEBSITE.jpg](https://gladiatorjoe.com/wp-content/uploads/2018/12/gladiatorjoe_monitor_vesa_adapter_GJ0A0005-R0_WEBSITE.jpg).

“Quick Attach VESA Adapter Plate Bracket” by Vivo, Published Online on [Apr. 18, 2019] [https://images-na.ssl-images-amazon.com/images/I/71stC5lwMLL.\\_AC\\_SL1500\\_.jpg](https://images-na.ssl-images-amazon.com/images/I/71stC5lwMLL._AC_SL1500_.jpg).

“VESA Mount Adapter for Dell Monitors” by HumanCentric, Published Online on [Mar. 22, 2016] [https://images-na.ssl-images-amazon.com/images/I/7139VXQxrbL.\\_AC\\_SL1500\\_.jpg](https://images-na.ssl-images-amazon.com/images/I/7139VXQxrbL._AC_SL1500_.jpg).

“VESA Adapter For Samsung Monitors” by HumanCentric, Found Online on [May 16, 2019] <https://cdn.shopify.com/s/files/1/0750/2813/files/101-1011-dimensions.png?17783914482415288115>.

“VESA Mount Adapter Bracket for Samsung Monitors” by HumanCentric, Found Online on [May 16, 2019] [https://images-na.ssl-images-amazon.com/images/I/61%2BfjiQunOL.\\_SL1500\\_.jpg](https://images-na.ssl-images-amazon.com/images/I/61%2BfjiQunOL._SL1500_.jpg).

“VESA Mount Adapter for Dell” by HumanCentric, , Published Online on [Mar. 20, 2017] [https://images-na.ssl-images-amazon.com/images/I/81qvme2pgmL.\\_AC\\_SL1500\\_.jpg](https://images-na.ssl-images-amazon.com/images/I/81qvme2pgmL._AC_SL1500_.jpg).

\* cited by examiner

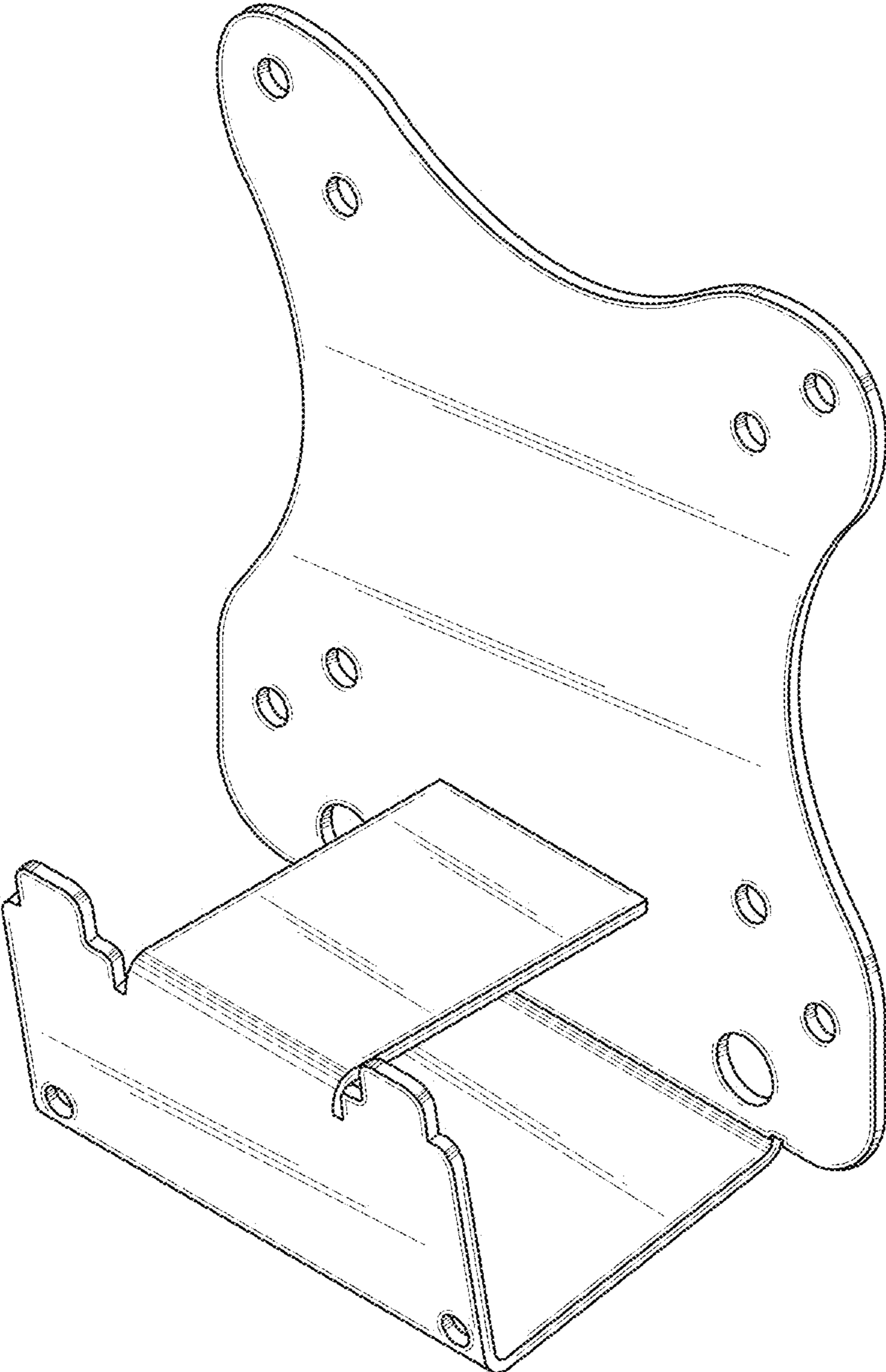

FIG. 1

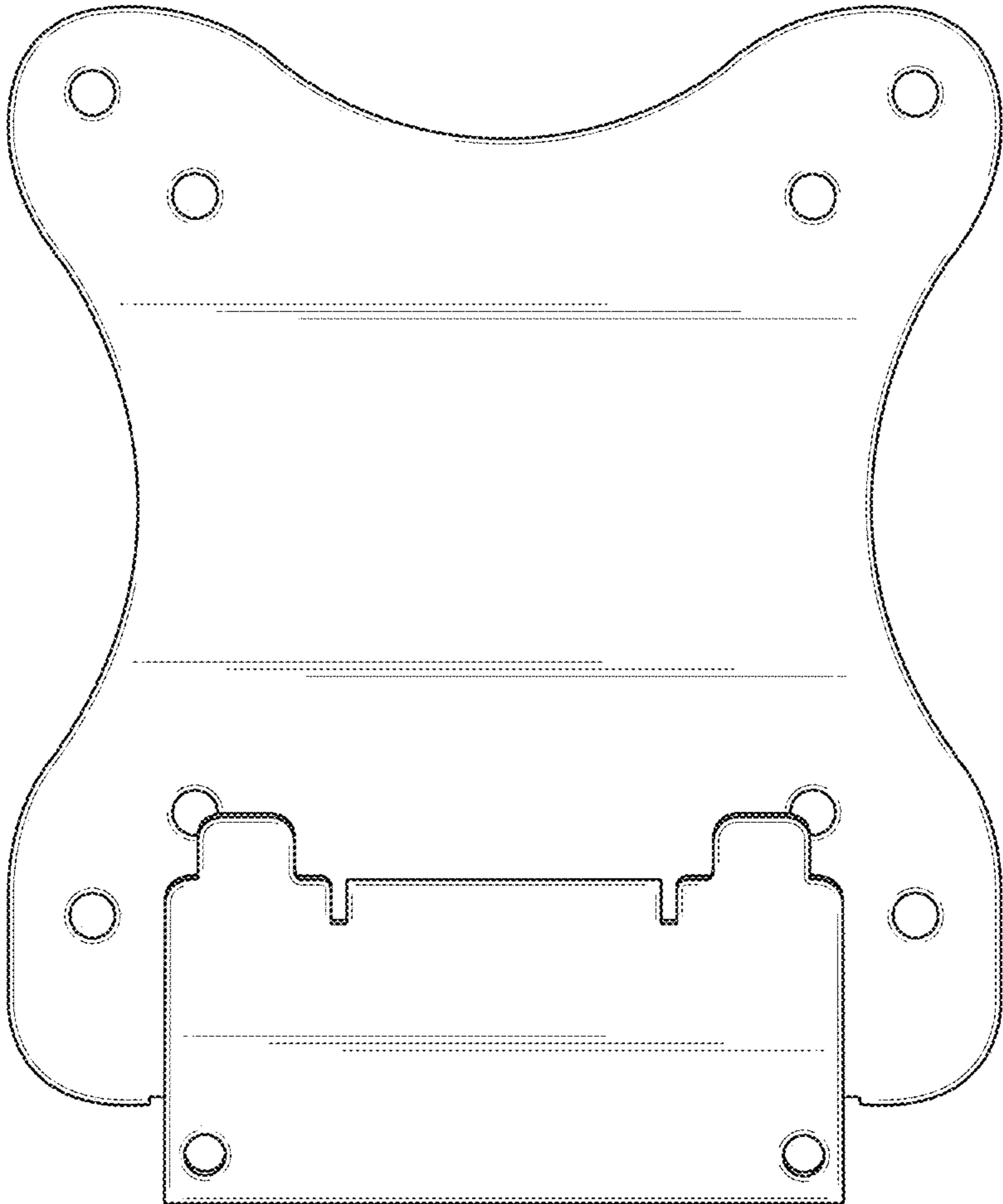
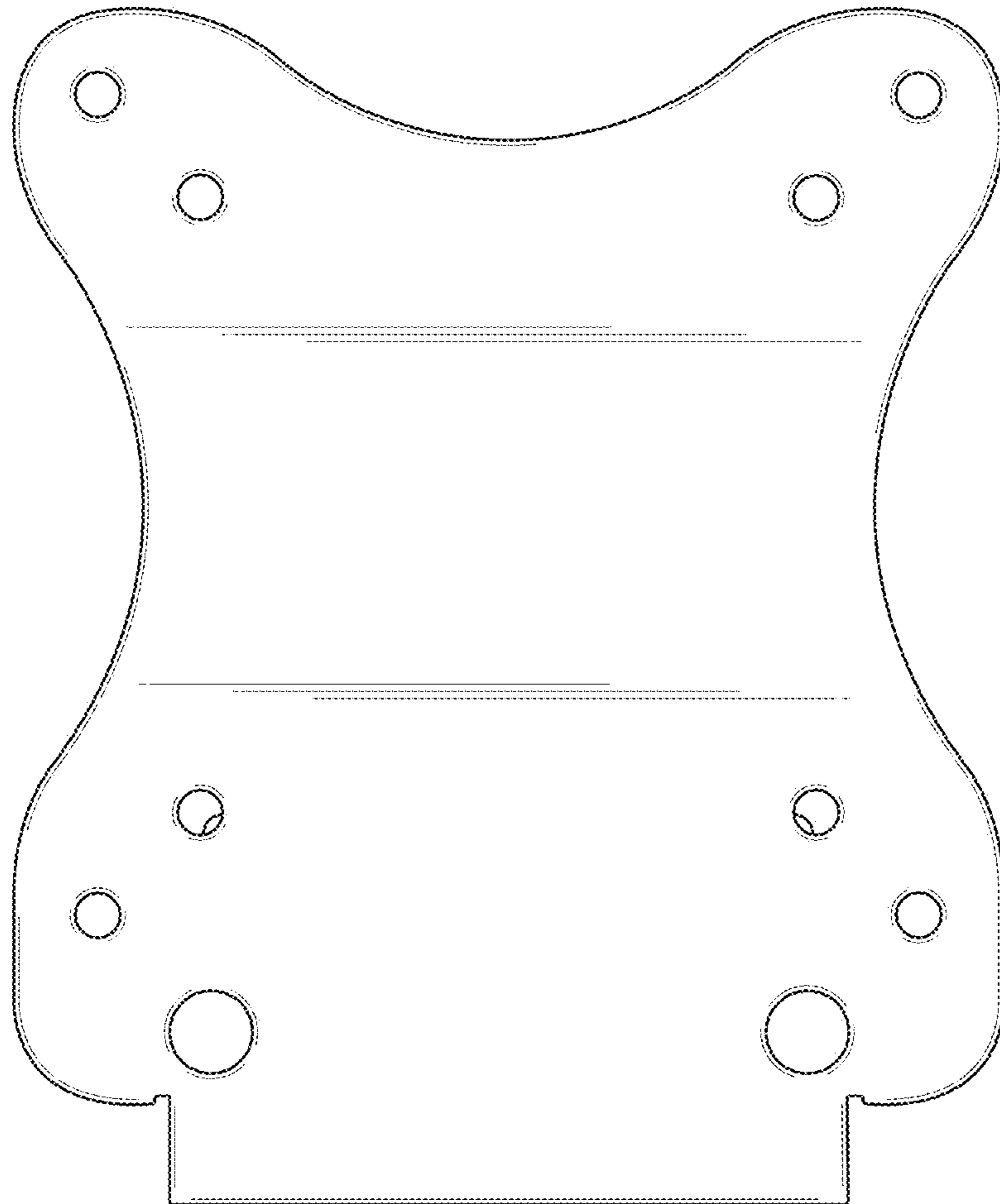
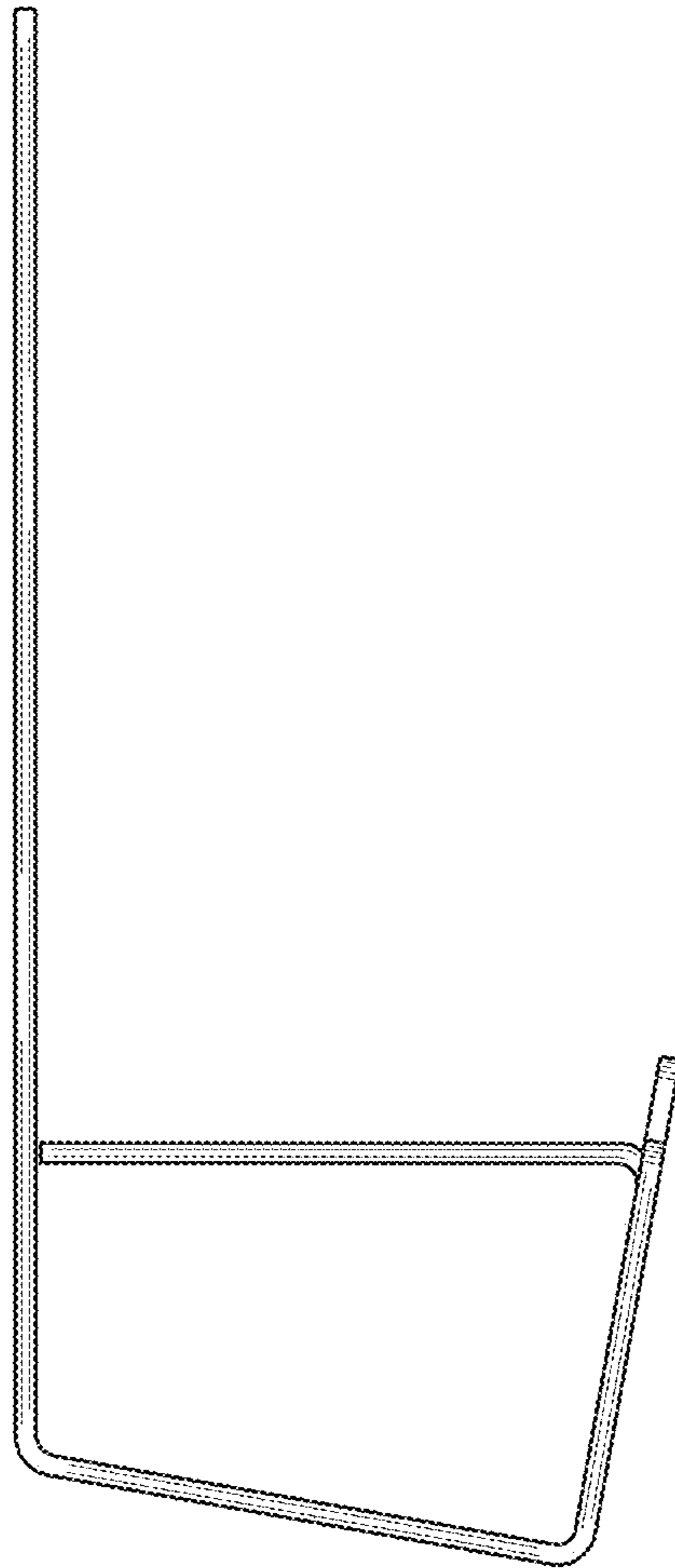

FIG. 2



**FIG. 3**



**FIG. 4**

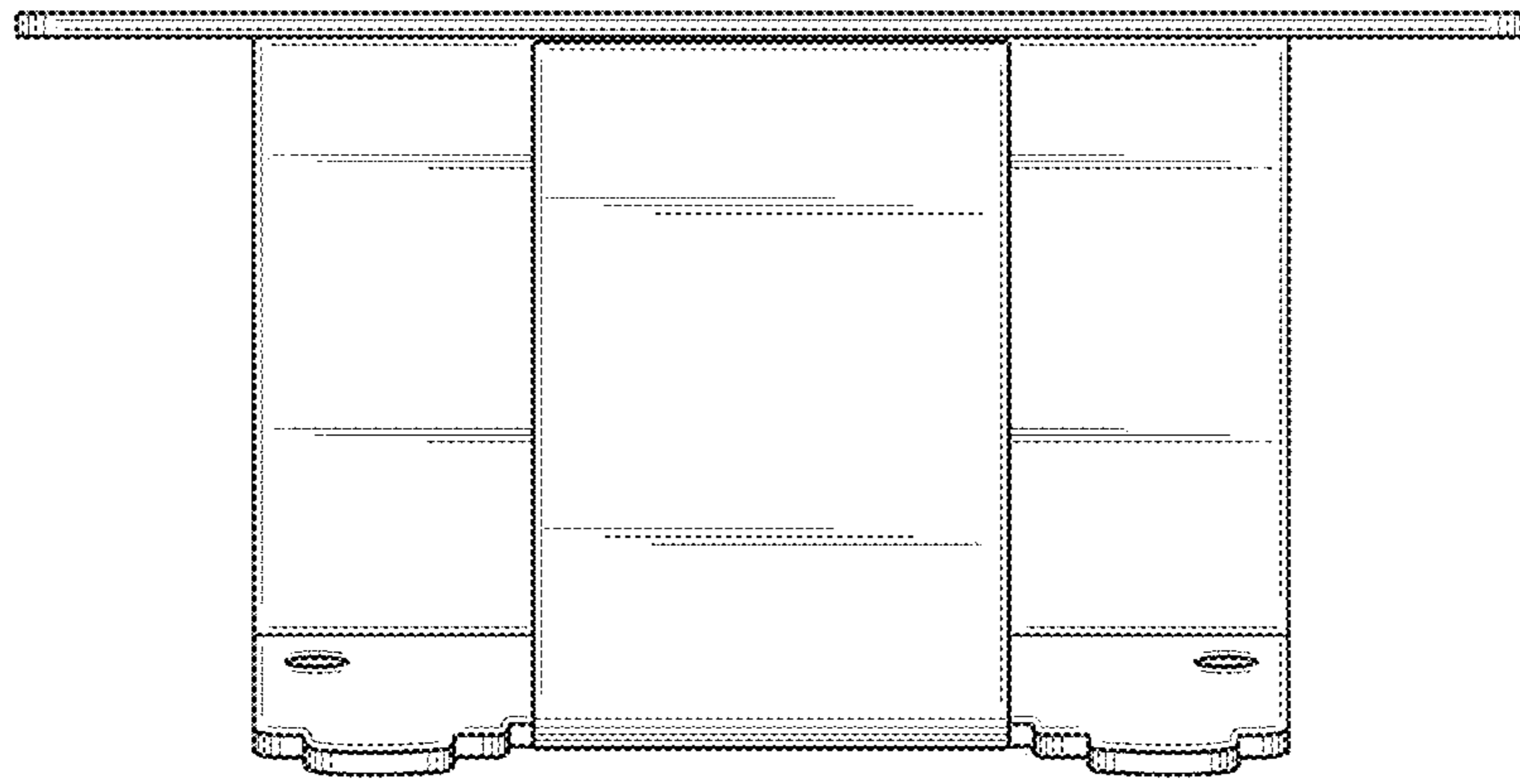

FIG. 5

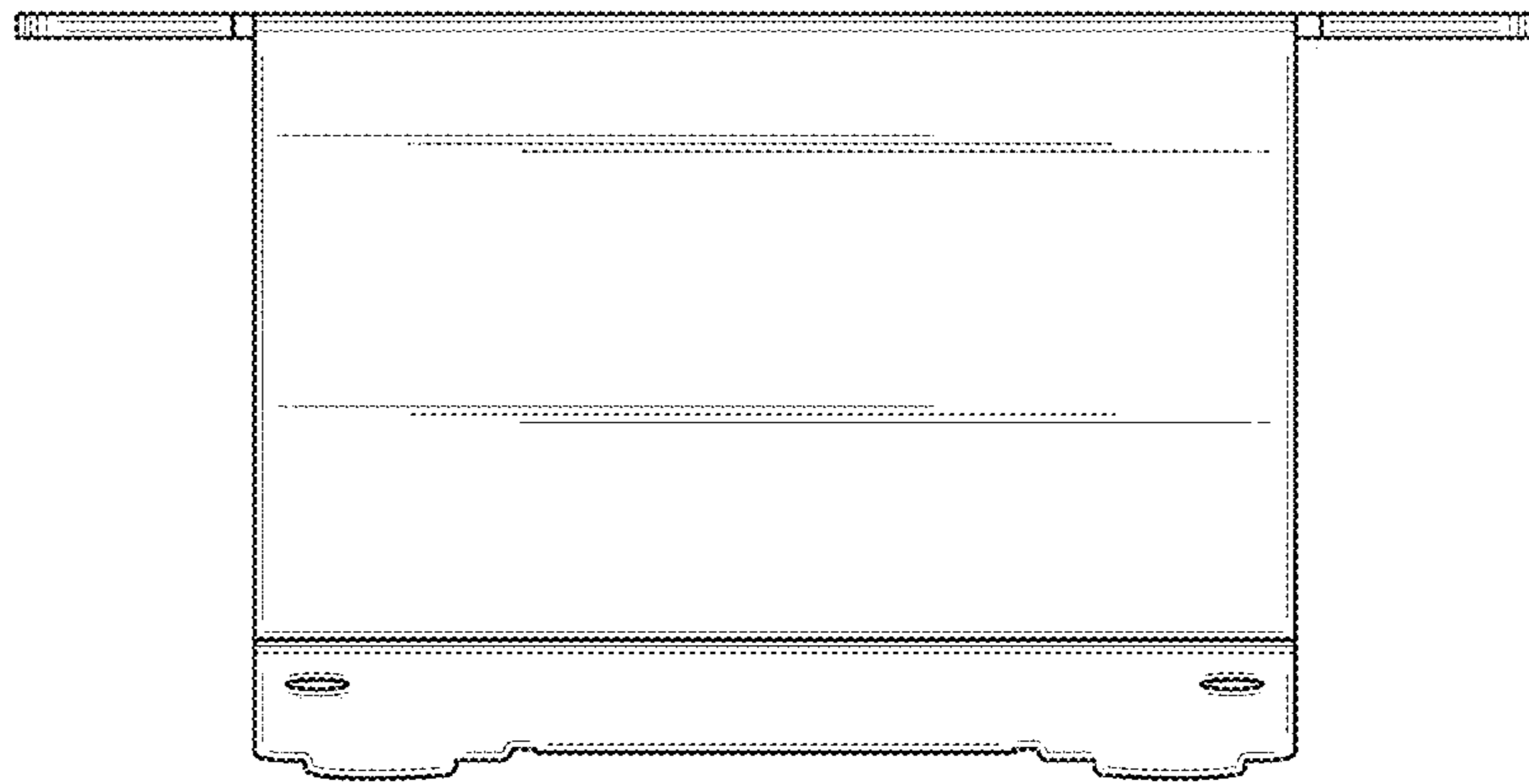

FIG. 6