



US00D928544S

(12) **United States Design Patent** (10) **Patent No.:** **US D928,544 S**
O'Shaughnessy et al. (45) **Date of Patent:** **** Aug. 24, 2021**

(54) **GRILL ASSEMBLY**

(71) Applicant: **O'Shaughnessy Holding Company, LLC**, Eden Prairie, MN (US)
(72) Inventors: **Michael L. O'Shaughnessy**, Edina, MN (US); **James A. Mitlyng**, Minneapolis, MN (US); **Thomas E. McKinney, II**, Minnetonka, MN (US); **Cynthia O'Connor**, Minneapolis, MN (US); **Robb Whittlef**, Minneapolis, MN (US)

(73) Assignee: **OHC IP Holdings, LLC**, Eden Prairie, MN (US)

(**) Term: **15 Years**

(21) Appl. No.: **29/695,969**

(22) Filed: **Jun. 24, 2019**

(51) **LOC (13) Cl.** **07-02**

(52) **U.S. Cl.**
USPC **D7/334**

(58) **Field of Classification Search**
USPC D3/276, 294-296, 905; D6/336, 553, D6/656, 663, 691, 698, 699.2, 699.4, 702,
(Continued)

(56) **References Cited**

U.S. PATENT DOCUMENTS

3,802,413 A 4/1974 Pepin
4,211,206 A 7/1980 Darbo
(Continued)

FOREIGN PATENT DOCUMENTS

CN 201005546 1/2008
CN 202801180 3/2013
(Continued)

OTHER PUBLICATIONS

Nationwide Marketing Group Announces Its Partnership With TYTUS Grills, first available Oct. 9, 2019, TytusGrills.com, [online], [site visited Nov. 27, 2020], Available from internet URL: <https://www.twice.com/retailing/nationwide-marketing-group-announces-its-partnership-with-tytus-grills> (Year: 2019).*

(Continued)

Primary Examiner — Mary Ann Calabrese
Assistant Examiner — Natalya M Rapundalo
(74) *Attorney, Agent, or Firm* — Pauly, DeVries Smith & Deffner LLC

(57) **CLAIM**

The ornamental design for a grill assembly, as shown and described.

DESCRIPTION

FIG. 1 is a front perspective view of a grill assembly.
FIG. 2 is a front view of the grill assembly.
FIG. 3 is a right side view of the grill assembly.
FIG. 4 is a left side view of the grill assembly.
FIG. 5 is a top view of the grill assembly.
FIG. 6 is a front perspective view of an alternate grill assembly with a wood finish.
FIG. 7 is a front view of the grill assembly of FIG. 6.
FIG. 8 is a right side view of the grill assembly of FIG. 6.
FIG. 9 is a left side view of the grill assembly of FIG. 6.
FIG. 10 is a top view of the grill assembly of FIG. 6.
FIG. 11 is a front perspective view of a further alternate grill assembly with a stone finish.
FIG. 12 is a front view of the grill assembly of FIG. 11.
FIG. 13 is a right side view of the grill assembly of FIG. 11.
FIG. 14 is a left side view of the grill assembly of FIG. 11; and,
FIG. 15 is a top view of the grill assembly of FIG. 11.
The broken lines in the drawings illustrate portions of the article that form no part of the claimed design. The back view and bottom view of the grill assembly form no part of the claimed design.

1 Claim, 15 Drawing Sheets

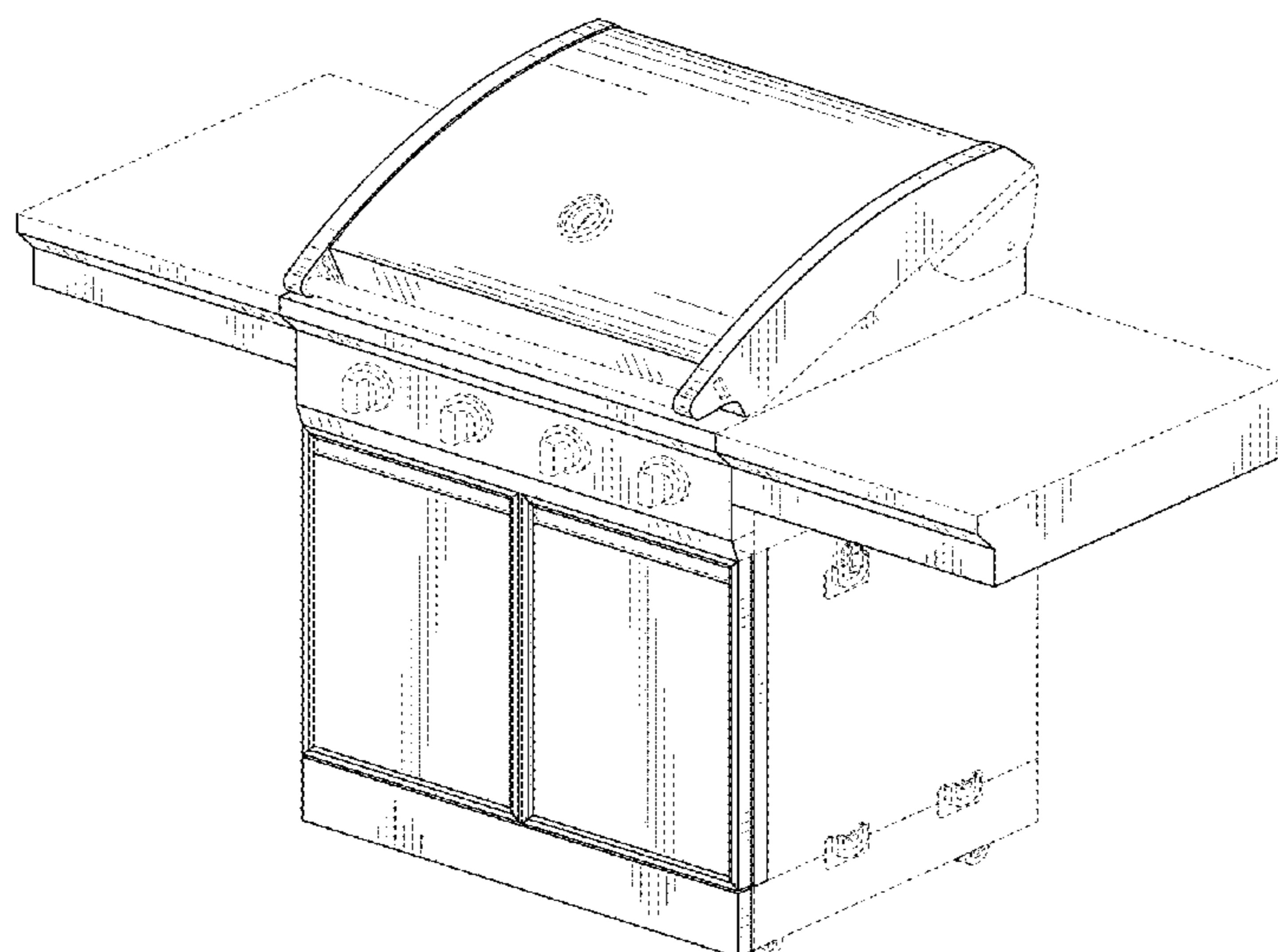

(58) **Field of Classification Search**

USPC D6/703; D7/332-339, 347, 352, 356,
D7/360, 362-366, 402-409; D23/314,
D23/332, 335, 339, 343, 345, 348, 415
CPC A47B 2003/025; A47B 2003/0821; A47B
2003/0824; A47B 3/02; A47B 3/08; A47B
3/087; A47B 3/091; A47B 33/00; A47B
35/00; A47B 37/04; A47B 47/00; A47B
77/00; A47J 2201/00; A47J 2202/00;
A47J 27/00; A47J 33/00; A47J 36/00;
A47J 37/00; A47J 43/00; A47J 44/00;
F24B 1/00; F24B 3/00; F24B 5/00
See application file for complete search history.

9,783,216 B2 10/2017 Alden et al.
9,788,690 B2 10/2017 Rosian
9,817,108 B2 11/2017 Kuo et al.
D805,332 S 12/2017 Price et al.
D805,819 S 12/2017 Price et al.
D820,010 S * 6/2018 Reyes D6/663
10,689,018 B2 6/2020 Patton et al.
10,702,099 B2 7/2020 O'Shaughnessy et al.
10,772,466 B2 9/2020 O'Shaughnessy et al.
D899,176 S 10/2020 Lien
10,966,569 B2 4/2021 O'Shaughnessy et al.
11,033,147 B2 6/2021 O'Shaughnessy et al.
11,045,049 B2 6/2021 O'Shaughnessy et al.
D923,996 S 7/2021 O'Shaughnessy et al.
D924,002 S 7/2021 O'Shaughnessy et al.

(56) **References Cited**

U.S. PATENT DOCUMENTS

4,569,327 A 2/1986 Velten
4,577,772 A 3/1986 Bigliardi
4,887,836 A 12/1989 Simjian
4,949,701 A 8/1990 Krosop et al.
4,984,515 A 1/1991 Pivonka
5,040,809 A 8/1991 Yang
5,050,731 A 9/1991 Baynes et al.
5,065,734 A 11/1991 Elliott
5,261,550 A 11/1993 Karpisek
5,318,322 A 6/1994 Home
5,462,318 A 10/1995 Cooke
5,579,755 A 12/1996 Johnston
5,884,554 A 3/1999 Sprick
6,026,751 A 2/2000 Tsai
6,039,039 A 3/2000 Pina, Jr.
6,316,837 B1 11/2001 Song
6,401,953 B2 6/2002 Kofod
6,439,111 B1 8/2002 Lu
6,439,220 B1 8/2002 Johnson
6,439,221 B1 8/2002 Ward et al.
6,494,419 B2 12/2002 Pai
6,532,951 B1 3/2003 Sallie et al.
6,606,986 B2 8/2003 Holland et al.
6,619,600 B1 9/2003 Johnson et al.
D485,467 S * 1/2004 Pai D7/334
D491,414 S * 6/2004 Nichols D7/402
6,792,880 B2 9/2004 Tsai
6,823,858 B1 11/2004 Chen
6,916,028 B2 7/2005 Shapiro
7,080,640 B2 7/2006 Sanders et al.
D533,011 S * 12/2006 Pai D7/334
D541,576 S * 5/2007 Lutz D7/334
D546,616 S * 7/2007 Tseng D7/334
D546,624 S * 7/2007 Pai D7/406
D547,108 S * 7/2007 Tseng D7/332
D547,109 S * 7/2007 Tseng D7/334
D549,035 S 8/2007 Chung
7,360,783 B2 4/2008 Home
D615,799 S * 5/2010 Best D7/337
D618,951 S * 7/2010 Tzeng G01F 23/20
D7/334
7,753,047 B1 7/2010 Trammell
7,856,924 B1 12/2010 Stihl
8,042,829 B2 10/2011 Hailston et al.
8,316,837 B2 11/2012 Malumyan
8,347,874 B2 1/2013 Bruno et al.
8,479,928 B2 7/2013 Tanabe et al.
8,522,769 B2 9/2013 Ducate, Jr. et al.
8,602,017 B2 12/2013 May et al.
RE44,770 E * 2/2014 Nichols D7/402
8,839,780 B1 9/2014 Bennett et al.
D737,096 S * 8/2015 Lee A47J 37/0704
D7/402
9,187,108 B2 11/2015 Bruno et al.
9,211,036 B2 12/2015 May et al.
9,316,401 B1 4/2016 Guste
9,392,904 B2 7/2016 Garman
D798,645 S * 10/2017 Lira-Nunez A47J 37/0713
D7/334

2001/0015137 A1 8/2001 Ogrady et al.
2004/0020482 A1 2/2004 Chen
2004/0065313 A1 4/2004 Thompson
2006/0049725 A1 3/2006 Simon
2006/0225725 A1 10/2006 Rinaldo
2007/0089724 A1 4/2007 Home
2007/0152414 A1 7/2007 Home
2008/0066730 A1 3/2008 Ducate
2008/0245357 A1 * 10/2008 Meether A47J 37/0786
126/25 R
2010/0031950 A1 2/2010 Paslawski
2010/0269814 A1 10/2010 May et al.
2010/0326938 A1 12/2010 Zhu et al.
2011/0025005 A1 2/2011 Howell
2011/0041831 A1 2/2011 Dettloff
2011/0168155 A1 7/2011 Gallo
2011/0168168 A1 7/2011 Schneider
2011/0168593 A1 7/2011 Neufeld et al.
2012/0012091 A1 * 1/2012 Home A47J 37/0713
126/38
2012/0017890 A1 1/2012 May et al.
2013/0049311 A1 2/2013 Metters et al.
2013/0112088 A1 5/2013 May
2013/0312732 A1 11/2013 Brennan
2014/0069412 A1 3/2014 Garman
2014/0090635 A1 * 4/2014 May G01F 23/20
126/25 R
2014/0165992 A1 6/2014 May et al.
2014/0261394 A1 9/2014 Evans et al.
2015/0013667 A1 1/2015 Ho et al.
2015/0020796 A1 1/2015 Garman et al.
2015/0118006 A1 4/2015 Wallace-riley
2016/0305172 A1 10/2016 Grisendi
2017/0085114 A1 3/2017 Gao et al.
2017/0095114 A1 4/2017 O'shaughnessy et al.
2017/0143162 A1 5/2017 Olsen
2017/0159941 A1 6/2017 Kahler et al.
2018/0008095 A1 1/2018 Bennett et al.
2018/0132660 A1 5/2018 Suchevids
2018/0141576 A1 5/2018 Leffler et al.
2018/0280677 A1 10/2018 Knight
2018/0290677 A1 10/2018 Patton et al.
2018/0310765 A1 11/2018 May et al.
2019/0380533 A1 * 12/2019 Lien A47J 37/0704
2020/0000277 A1 1/2020 O'Shaughnessy et al.
2020/0000278 A1 1/2020 O'Shaughnessy et al.
2020/0000279 A1 1/2020 O'Shaughnessy et al.
2020/0000280 A1 1/2020 O'Shaughnessy et al.
2020/0000281 A1 1/2020 O'Shaughnessy et al.
2020/0000283 A1 1/2020 O'Shaughnessy et al.
2020/0390279 A1 12/2020 O'Shaughnessy et al.
2020/0391779 A1 12/2020 Patton et al.
2021/0045579 A1 2/2021 O'shaughnessy et al.

FOREIGN PATENT DOCUMENTS

CN 202807780 3/2013
CN 104234616 12/2014
CN 204618011 9/2015
CN 205632566 10/2016
CN 107198467 9/2017
CN 305874918 6/2020
CN 305874919 6/2020
CN 305874920 6/2020

(56)

References Cited

FOREIGN PATENT DOCUMENTS

JP	2006223643	8/2006
KR	200173343	4/2000
KR	20050102437	10/2005
KR	20130000879	2/2013
TW	309958	7/1997
WO	2004054415	7/2004
WO	2004072539	8/2004
WO	2015089551	6/2015
WO	2016149408	11/2016
WO	2017095746	6/2017
WO	2017160338	9/2017
WO	2018183373	10/2018
WO	2020005946	1/2020
WO	2020005969	1/2020
WO	2020005972	1/2020
WO	2020005976	1/2020
WO	2020005978	1/2020
WO	2020005981	1/2020

OTHER PUBLICATIONS

TYTUS TI404MGGLP Spec Sheet, first available 2020, AppliancesConnection.com, [online], [site visited Nov. 27, 2020], Available from internet URL: <https://static.appliancesconnection.com/attachments/D5f524932e12f6.pdf> (Year: 2020).*

TYTUS TI400SSBLP341 Spec Sheet, first available 2020, AppliancesConnection.com, [online], [site visited Nov. 27, 2020], Available from internet URL: <https://static.appliancesconnection.com/attachments/D5f524e4ae6c38.pdf> (Year: 2020).*

TYTUS TI400MWLP Spec Sheet, first available 2020, SamsClub.com, [online], [site visited Nov. 27, 2020], Available from internet URL: <https://content.syndigo.com/asset/9f3410f8-d6c3-48c1-a02c-f5bdbb9f989b/original.pdf> (Year: 2020).*

TYTUS User Manual 4-Burner Gas Grill and 4-Burner Island Gas Grill with Side Cabinets, first available 2020, TytusGrills.com, [online], [site visited Dec. 1, 2020], Available from internet URL: <https://tytusgrills.com/pages/manualsanddocuments> (Year: 2020).*

TYTUS Grills, first available 2020, TytusGrills.com, [online], [site visited Dec. 1, 2020], Available from internet URL: <https://tytusgrills.com/collections/grills> (Year: 2020).*

TYTUS Charcoal Grey Stainless Steel 4 Burner Free Standing Grill, first available 2020, TytusGrills.com, [online], [site visited Nov. 27, 2020], Available from internet URL: <https://tytusgrills.com/collections/grills/products/tytus-charcoal-grey-stainless-steel-4-burner-free-standing-grill> (Year: 2020).*

“Final Office Action,” for U.S. Appl. No. 15/262,733 dated Sep. 5, 2019 (14 pages).

“International Preliminary Report on Patentability,” for PCT Application No. PCT/US2018/024628 dated Oct. 10, 2019 (13 pages).

“International Search Report and Written Opinion,” for PCT Application No. PCT/US2019/038993 dated Oct. 15, 2019 (13 pages).

“International Search Report and Written Opinion,” for PCT Application No. PCT/US2019/039024 dated Oct. 15, 2019 (14 pages).

“International Search Report and Written Opinion,” for PCT Application No. PCT/US2019/039027 dated Oct. 15, 2019 (13 pages).

“International Search Report and Written Opinion,” for PCT Application No. PCT/US2019/039034 dated Oct. 15, 2019 (12 pages).

“International Search Report and Written Opinion,” for PCT Application No. PCT/US2019/039039 dated Oct. 16, 2019 (14 pages).

“International Search Report and Written Opinion,” for PCT Application No. PCT/US2019/039042 dated Oct. 16, 2019 (13 pages).

“Non-Final Office Action,” for U.S. Appl. No. 16/450,303 dated Oct. 24, 2019 (19 pages).

“Non-Final Office Action,” for U.S. Appl. No. 16/450,541 dated Oct. 1, 2019 (21 pages).

“Second Office Action,” for Chinese Patent Application No. 201610876505.3 dated Aug. 29, 2019 (4 pages) with English Translation.

“Sunco Outdoor Kitchen,” Mar. 16, 2018 URL <<https://www.sunco.com.au/shop/bbqs/sc100-xspec-four-burner-outdoor-kitchen/>> (3 pages).

“Char-Broil Modular Outdoor Kitchen,” Char Broil webpage Apr. 29, 2019, retrieved on Aug. 8, 2019, <https://www.charbroil.com/grills/outdoor-kitchens/modular-outdoor-kitchen> (4 pages).

“Denver’s Post and Panel System,” Denver webpage Jun. 1, 2018, retrieved on Aug. 8, 2019, <https://denver.com/blog/post-and-panel-system/> (2 pages).

“Final Office Action,” for U.S. Appl. No. 16/450,541 dated Feb. 5, 2020 (19 pages).

“Non-Final Office Action,” for U.S. Appl. No. 15/262,733 dated Jan. 8, 2020 (18 pages).

“Notice of Allowance,” for U.S. Appl. No. 15/937,666 dated Feb. 18, 2020 (14 pages).

“Notice of Allowance,” for U.S. Appl. No. 16/450,303 dated Feb. 14, 2020 (13 pages).

“Notice of Allowance,” for U.S. Appl. No. 16/450,541 dated May 14, 2020 (12 pages).

“Origami Carts and Racks,” Origami webpage Apr. 20, 2016, retrieved on Dec. 9, 2019 via web.archive.org, <https://origamirack.com> 5 pages.

“Response to Final Office Action,” for U.S. Appl. No. 15/262,733, filed Dec. 5, 2019 (11 pages).

“Response to Final Office Action,” for U.S. Appl. No. 16/450,541, filed May 5, 2020 (7 pages).

“Response to Non Final Office Action,” for U.S. Appl. No. 16/450,541, filed Dec. 30, 2019 (16 pages).

“Third Office Action,” for Chinese Patent Application No. 201610876505.3 dated Mar. 19, 2020 (8 pages) with English Translation.

“Traeger Wood Pellet Grills,” Traeger Grills webpage Apr. 7, 2006, retrieved on Dec. 9, 2019 via web.archive.org, <https://www.traegergrills.com> (2 pages).

“Brown Jordan Outdoor Kitchens,” by Denver Stainless Outdoor Kitchens information booklet, Apr. 2018 (28 pages).

Colon, Linda M. “Denver’s Post and Panel System is a Hit with Architects, Builders, Developers & Designers,” Denver Outdoor Kitchens Jun. 1, 2018 (2 pages).

File History for U.S. Appl. No. 15/262,733 downloaded Aug. 23, 2019 (326 pages).

File History for U.S. Appl. No. 15/937,666 downloaded Aug. 23, 2019 (201 pages).

“First Office Action,” for Chinese Patent Application No. 20110876505.3 dated Dec. 18, 2018 (14 pages) with English Translation.

“International Preliminary Report on Patentability,” for PCT Application No. PCT/US2016/051319 dated Sep. 27, 2018 (11 pages).

“International Search Report and Written Opinion,” for PCT Application No. PCT/US2016/051319 dated Dec. 8, 2016 (14 pages).

“International Search Report and Written Opinion,” for PCT Application No. PCT/US2018/024628 dated Jul. 11, 2018 (16 pages).

“Modular Outdoor Kitchen,” Char-Broil Medallion Series Outdoor Kitchen information retrieved from <https://www.charbroil.com/grills/modular-outdoor-kitchen> on Aug. 8, 2019 (4 pages).

“Origami Kitchen Island Cart with Wheels,” Description and Product Specs at least as early as Aug. 9, 2019 (5 pages).

“Traeger Wood Pellet Grills,” Product Listing found on www.traegergrills.com at least as early as Aug. 9, 2019 (4 pages).

“Ex Parte Quayle Action,” for U.S. Appl. No. 29/695,966, mailed Dec. 11, 2020 (23 pages).

“Ex Parte Quayle Action,” for U.S. Appl. No. 29/695,973 mailed Dec. 11, 2020 (23 pages).

“Ex Parte Quayle Action,” for U.S. Appl. No. 29/695,976 mailed Dec. 11, 2020 (24 pages).

“Fourth Office Action,” for Chinese Patent Application No. 201610876505.3 dated Sep. 30, 2020 (11 pages) with English Summary.

“International Preliminary Report on Patentability,” for PCT Application No. PCT/US2019/038993 dated Jan. 7, 2021 (9 pages).

“International Preliminary Report on Patentability,” for PCT Application No. PCT/US2019/039024 dated Jan. 7, 2021 (10 pages).

“International Preliminary Report on Patentability,” for PCT Application No. PCT/US2019/039027 dated Jan. 7, 2021 (9 pages).

(56)

References Cited

OTHER PUBLICATIONS

“International Preliminary Report on Patentability,” for PCT Application No. PCT/US2019/039034 dated Jan. 7, 2021 (8 pages).

“International Preliminary Report on Patentability,” for PCT Application No. PCT/US2019/039039 dated Jan. 7, 2021 (10 pages).

“International Preliminary Report on Patentability,” for PCT Application No. PCT/US2019/039042 dated Jan. 7, 2021 (9 pages).

Morgan, Grant “Nationwide Marketing Group Announces Its Partnership with TYTUS Grills,” first available online Oct. 9, 2019, TytusGrills.com, [online], [site visited Nov. 27, 2020], available from internet URL: <https://www.twice.com/retailing/nationwide-marketing-group-announces-its-partnership-with-tytus-grills> (year: 2019).

“Non-Final Office Action,” for U.S. Appl. No. 16/450,356 dated Nov. 18, 2020 (31 pages).

“Non-Final Office Action,” for U.S. Appl. No. 16/450,493 dated Nov. 2, 2020 (26 pages).

“Non-Final Office Action,” for U.S. Appl. No. 16/450,510 dated Dec. 14, 2020 (32 pages).

“Notice of Allowance,” for U.S. Appl. No. 16/450,388 dated Dec. 1, 2020 (27 pages).

“Notice of Allowance,” for U.S. Appl. No. 16/450,493 dated Feb. 12, 2021 (21 pages).

“Response after Ex Parte Quayle Action,” for U.S. Appl. No. 29/695,966, filed Feb. 9, 2021 (4 pages).

“Response after Ex Parte Quayle Action,” for U.S. Appl. No. 29/695,973, filed Feb. 9, 2021 (4 pages).

“Response after Ex Parte Quayle Action,” for U.S. Appl. No. 29/695,976, filed Feb. 9, 2021 (4 pages).

“Response to Non Final Office Action,” for U.S. Appl. No. 16/450,493, filed Feb. 2, 2021 (11 pages).

“TYTUS Charcoal Grey Stainless Steel 4 Burner Free Standing Grill,” first available 2020, TytusGrills.com, [online], [site visited Nov. 27, 2020], Available from internet URL: <https://tytusgrills.com/collections/grills/products/tytus-charcoal-grey-stainless-steel-4-burner-free-standing-grill> (Year: 2020), 5 pages.

“TYTUS Grills,” first available 2020, TytusGrills.com, [online], [site visited Dec. 1, 2020], Available from internet URL: <https://tytusgrills.com/collections/grills> (Year: 2020), 3 pages.

“TYTUS TI404MGGLP Spec Sheet,” first available 2020, AppliancesConnection.com, [online], [site visited Nov. 27, 2020], Available from internet URL: <https://static.appliancesconnection.com/attachments/D5f524932e12f6.pdf> (Year: 2020), 2 pages.

“TYTUS TI400MWLP Spec Sheet,” first available 2020, SamsClub.com, [online], [site visited Nov. 27, 2020], Available from internet URL: <https://content.syndigo.com/asset/9f3410f8-d6c3-48c1-a02c-f5bdbb9f989b/original.pdf> (Year: 2020), 2 pages.

“TYTUS T1400SSBLP341 Spec Sheet,” first available 2020, AppliancesConnection.com, [online], [site visited Nov. 27, 2020], Available from internet URL: <https://static.appliancesconnection.com/attachments/D5f524e4ae6c38.pdf> (Year: 2020), 2 pages.

“TYTUS User Manual 4-Burner Gas Grill and 4-Burner Island Gas Grill with Side Cabinets,” first available 2020, TytusGrills.com, [online], [site visited Dec. 1, 2020], Available from internet URL: <https://tytusgrills.com/pages/manualsanddocuments> (Year: 2020), 60 pages).

“Notice of Allowance,” for Design U.S. Appl. No. 29/695,976 dated Mar. 8, 2021 (16 pages).

“Notice of Allowance,” for U.S. Appl. No. 16/450,356 dated Feb. 26, 2021 (17 pages).

“Notice of Allowance,” for U.S. Appl. No. 29/695,966 dated Mar. 1, 2021 (14 pages).

“Notice of Allowance,” for U.S. Appl. No. 29/695,973 dated Mar. 3, 2021 (16 pages).

“Response to Non Final Office Action,” for U.S. Appl. No. 16/450,356, filed Feb. 17, 2021 (11 pages).

“Notice of Allowance,” for U.S. Appl. No. 16/450,510 dated Mar. 22, 2021 (18 pages).

“Office Action,” for Chinese Patent Application No. 202022193760.2 dated Apr. 19, 2021 (4 pages) with English Translation.

* cited by examiner

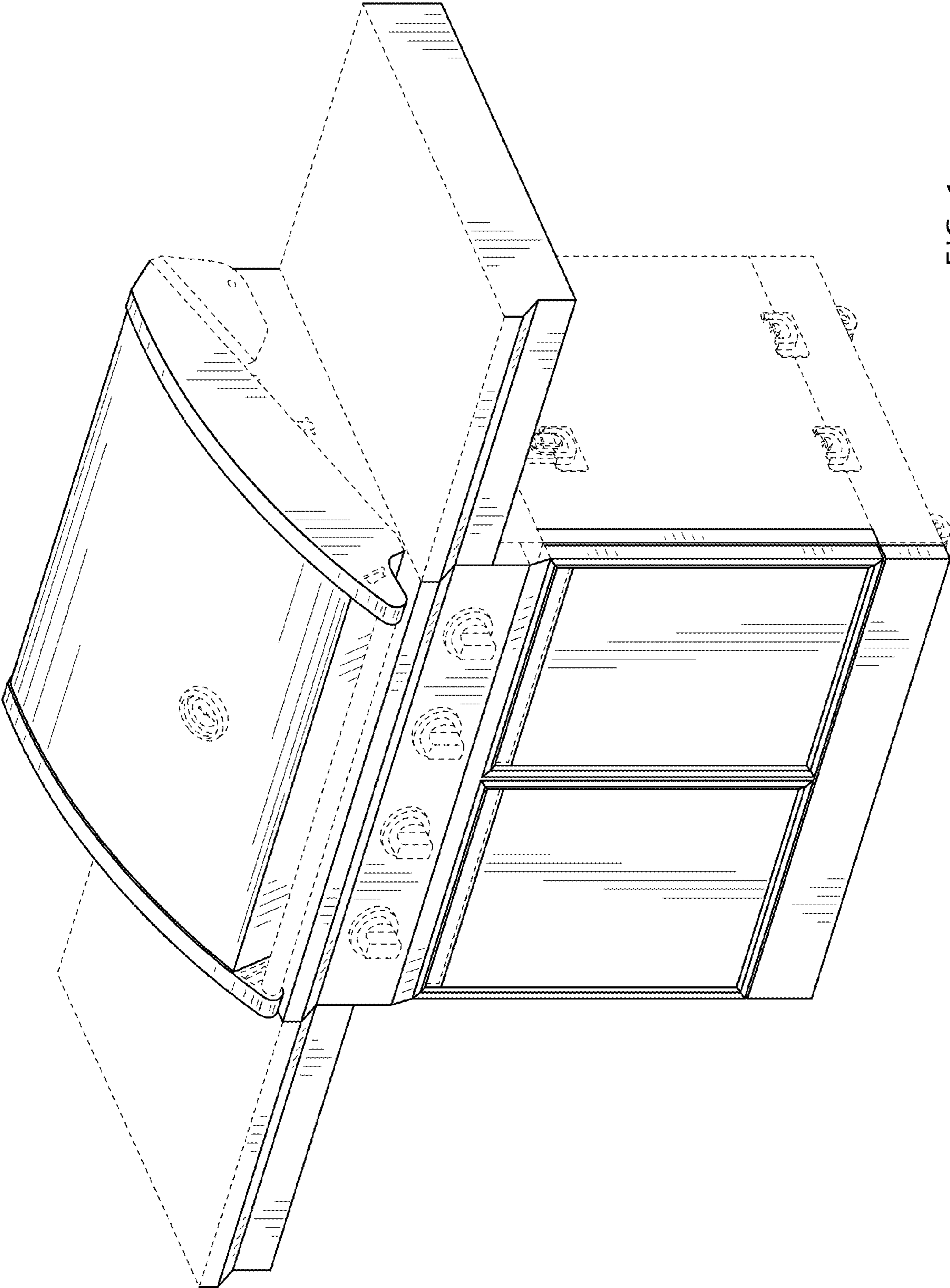

FIG. 1

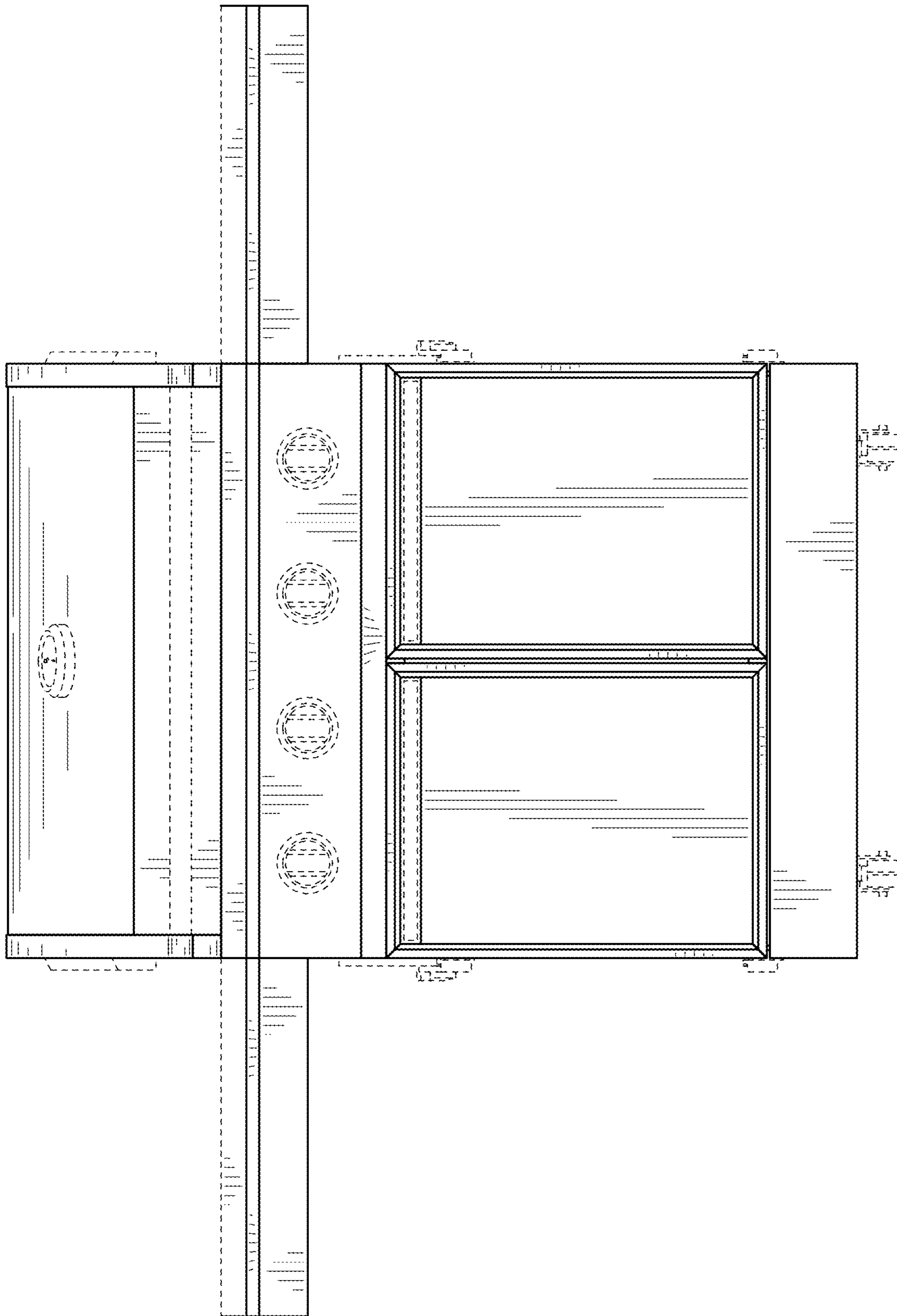

FIG. 2

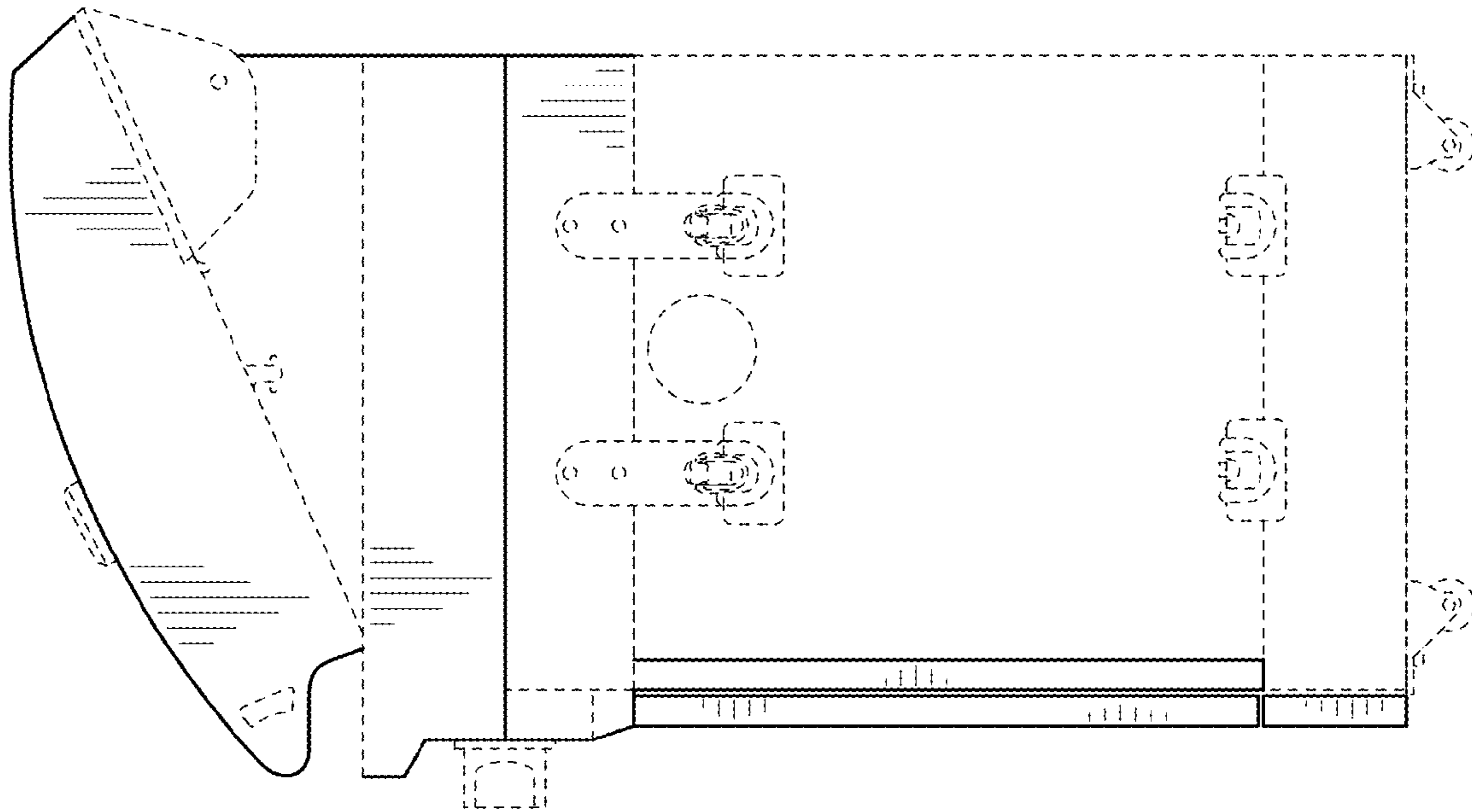

FIG. 3

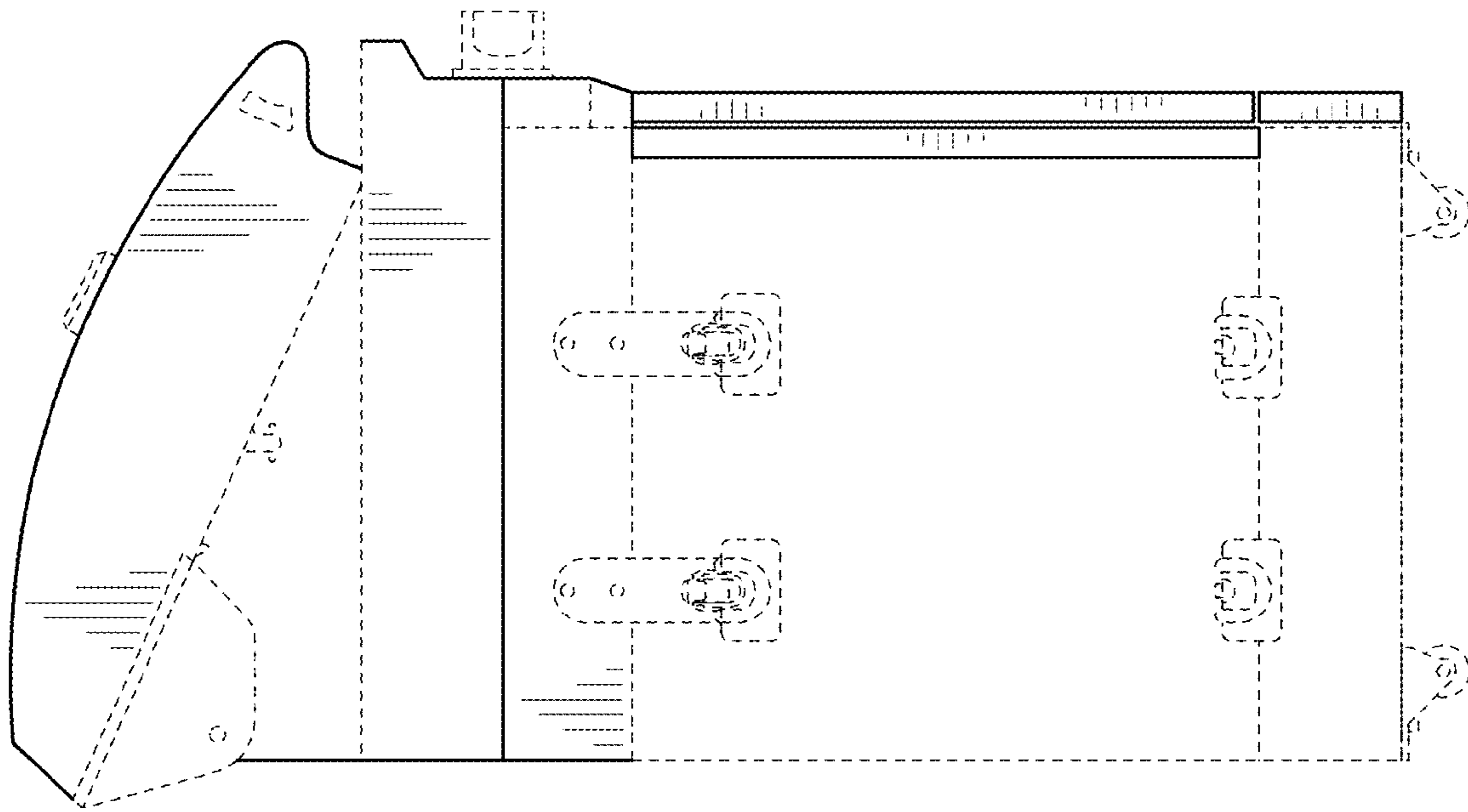

FIG. 4

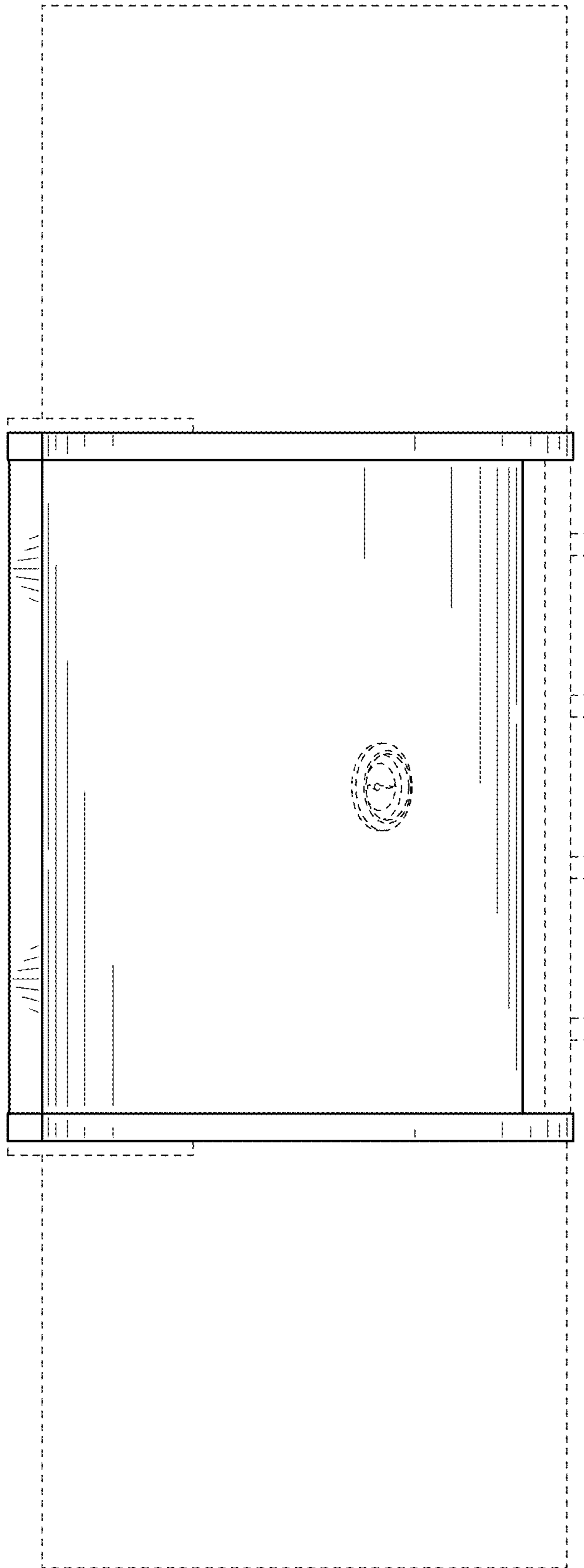

FIG. 5

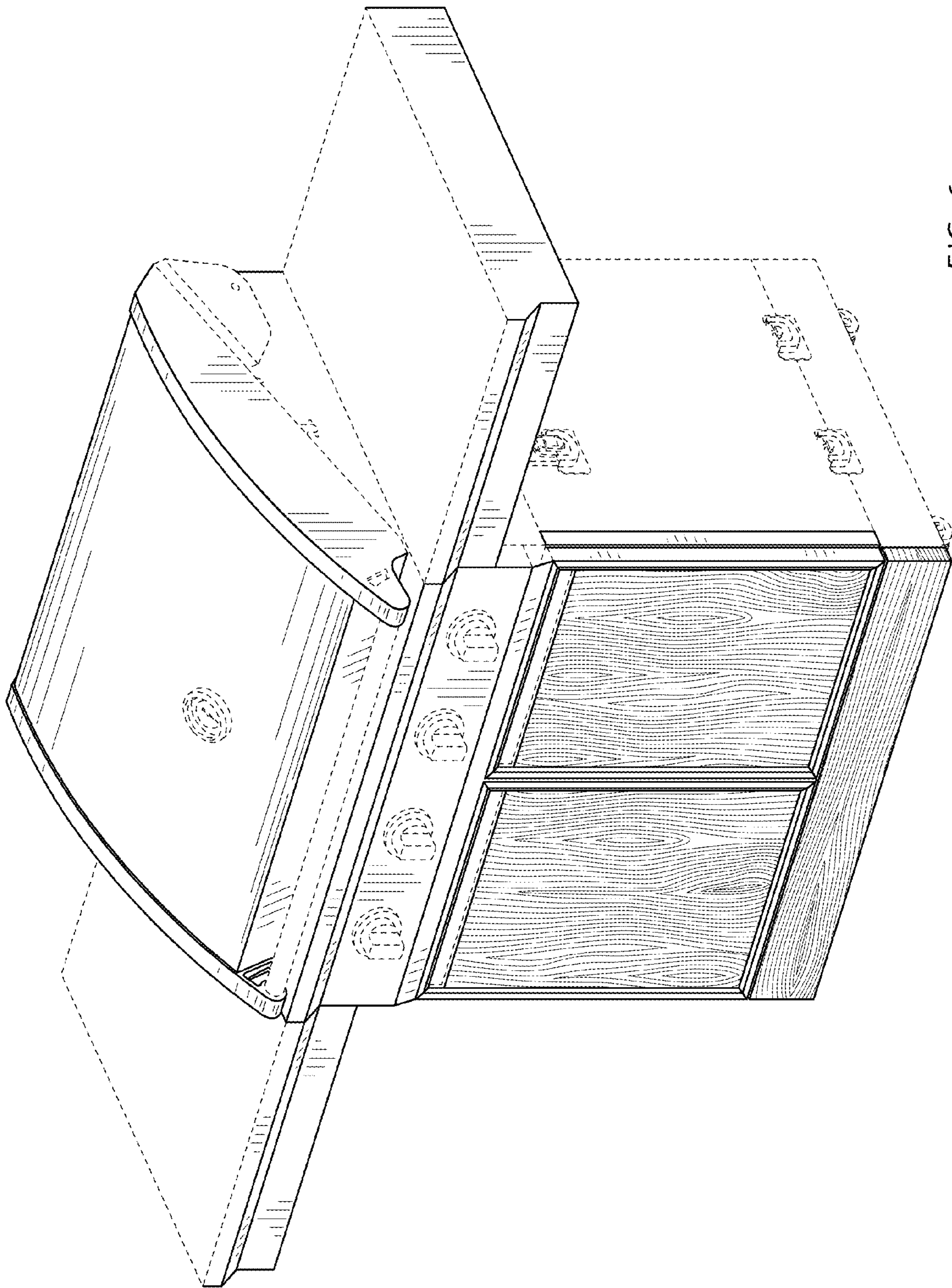

FIG. 6

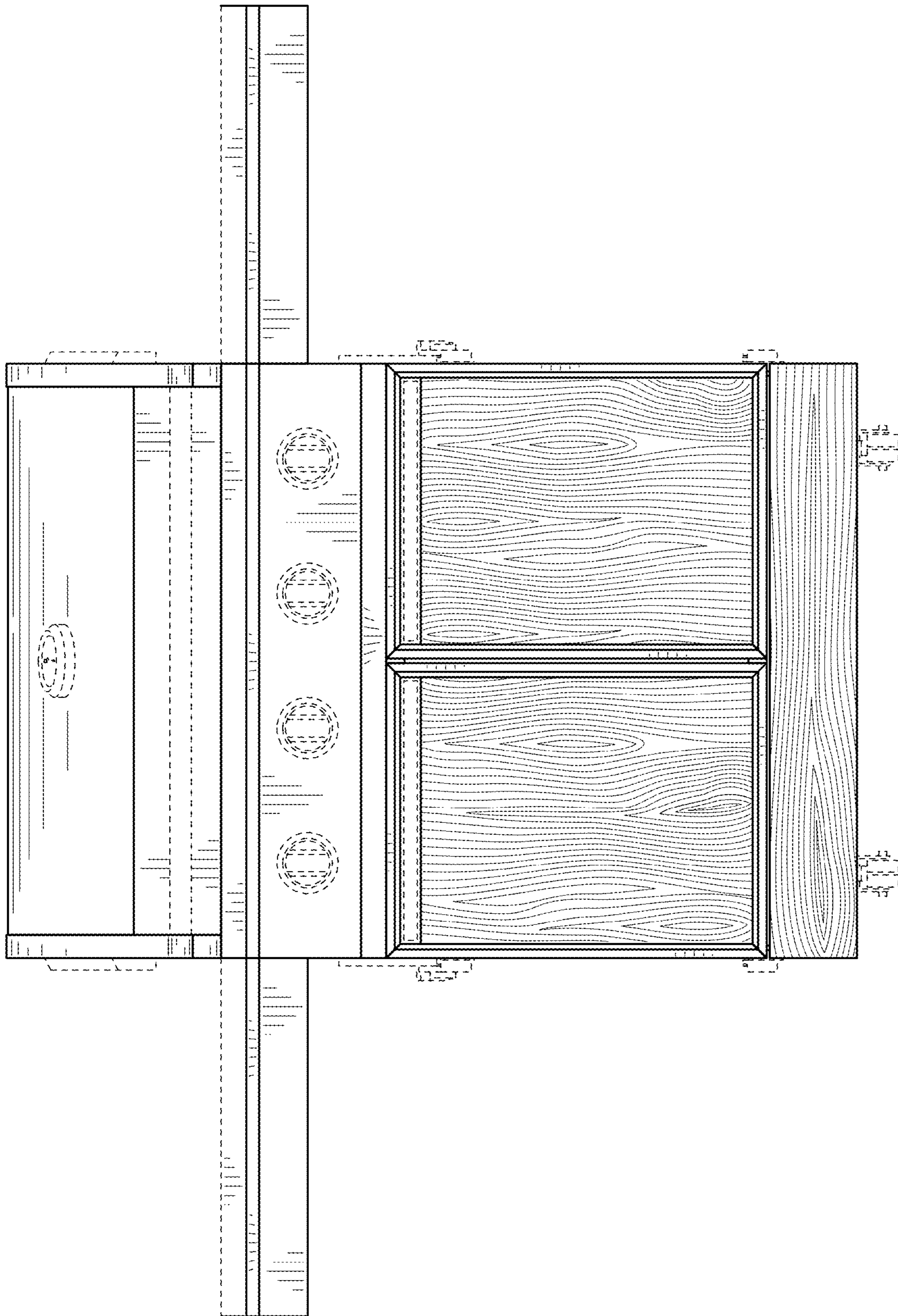

FIG. 7

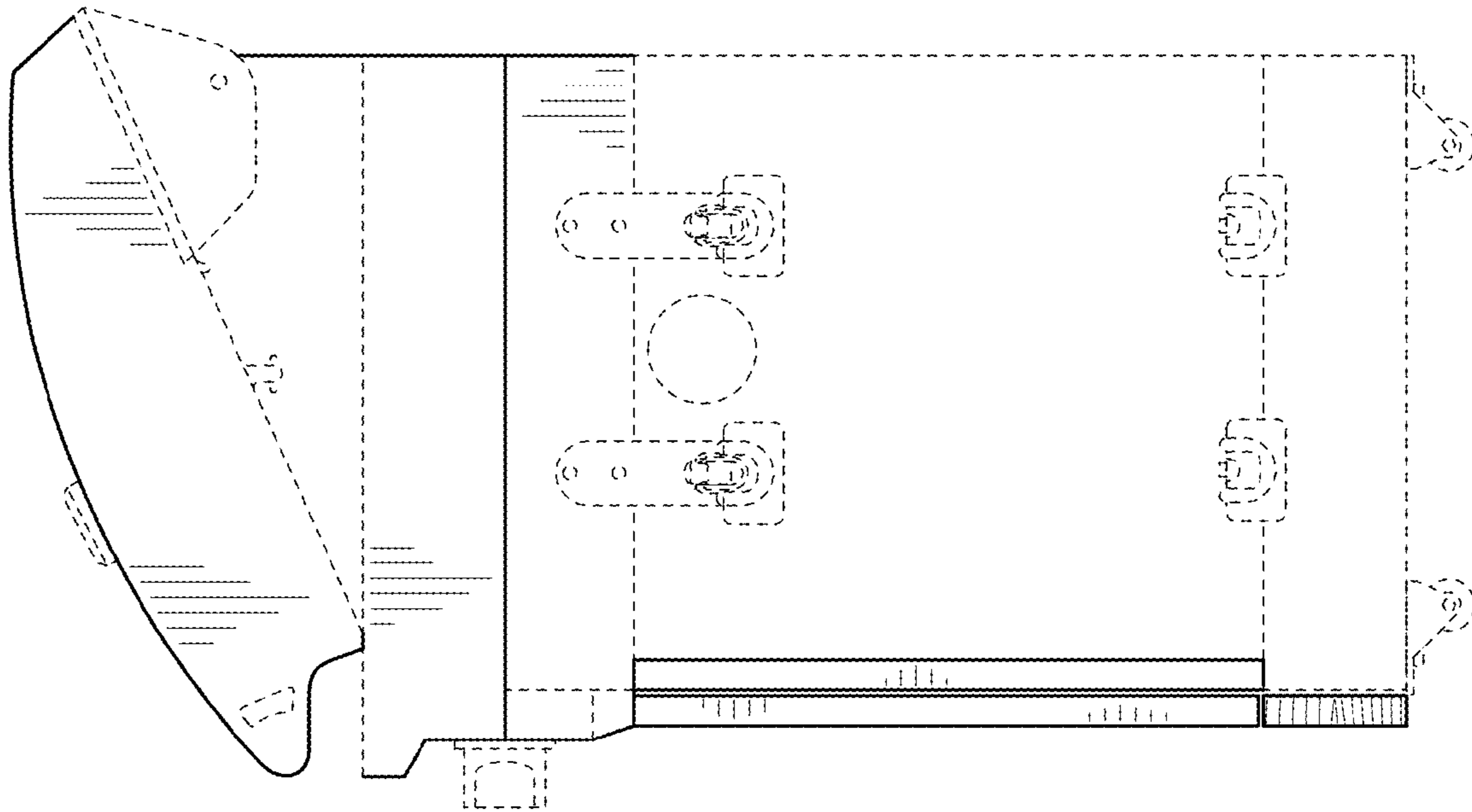

FIG. 8

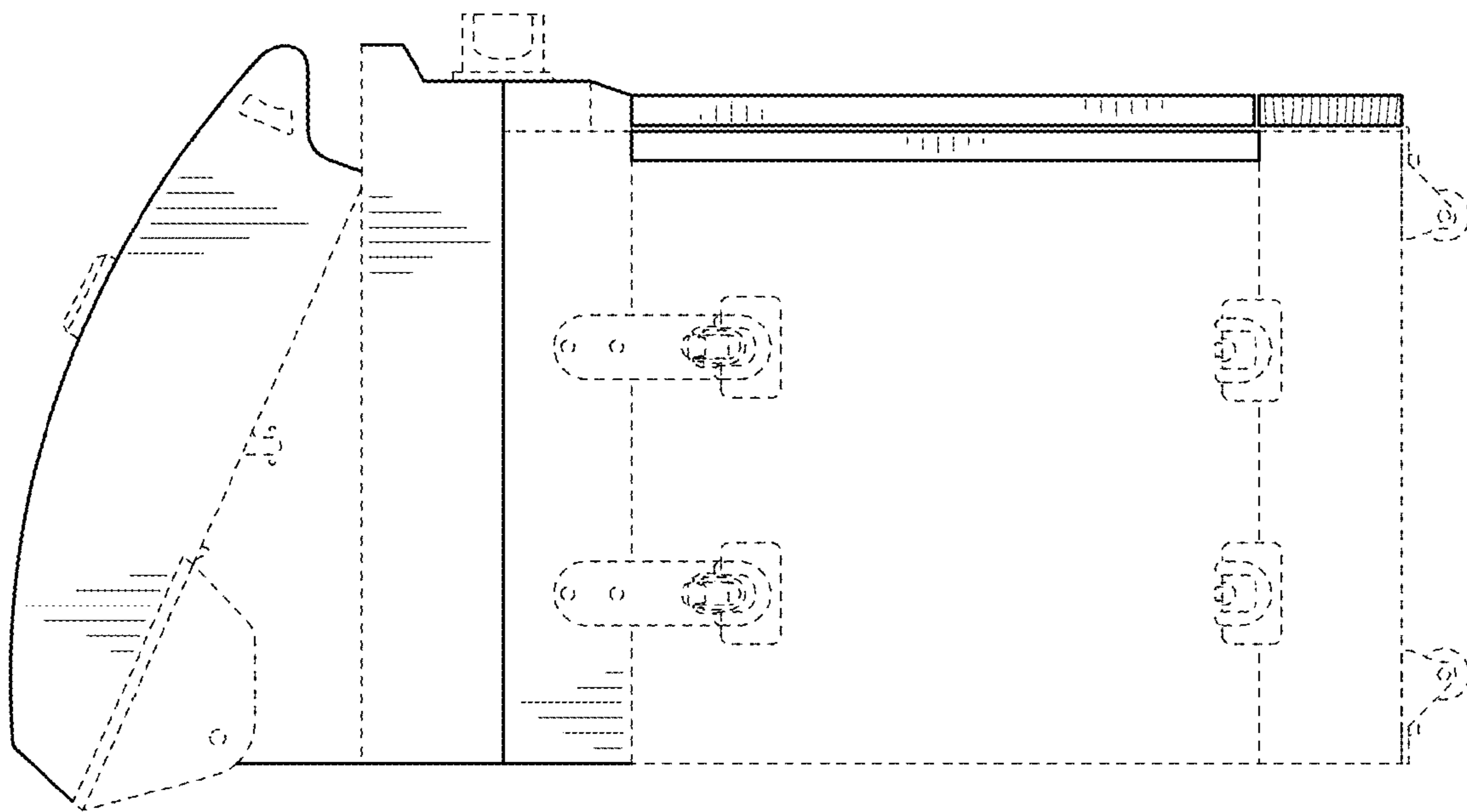

FIG. 9

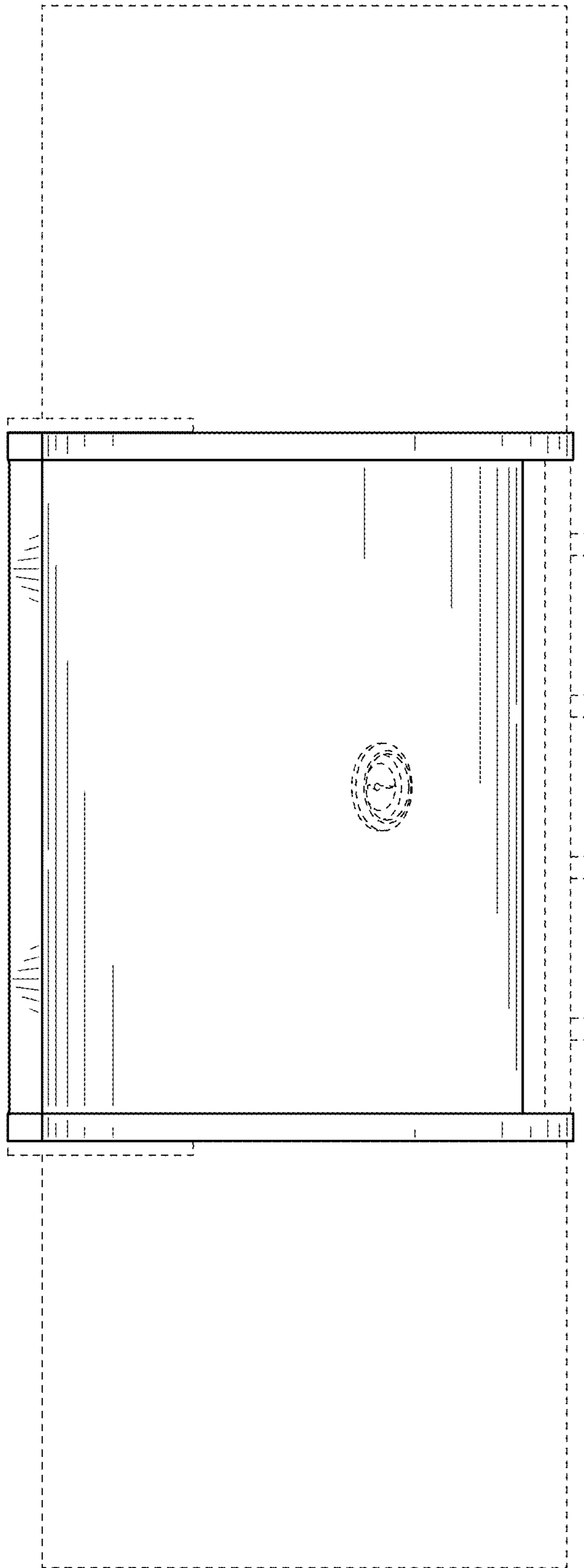

FIG. 10

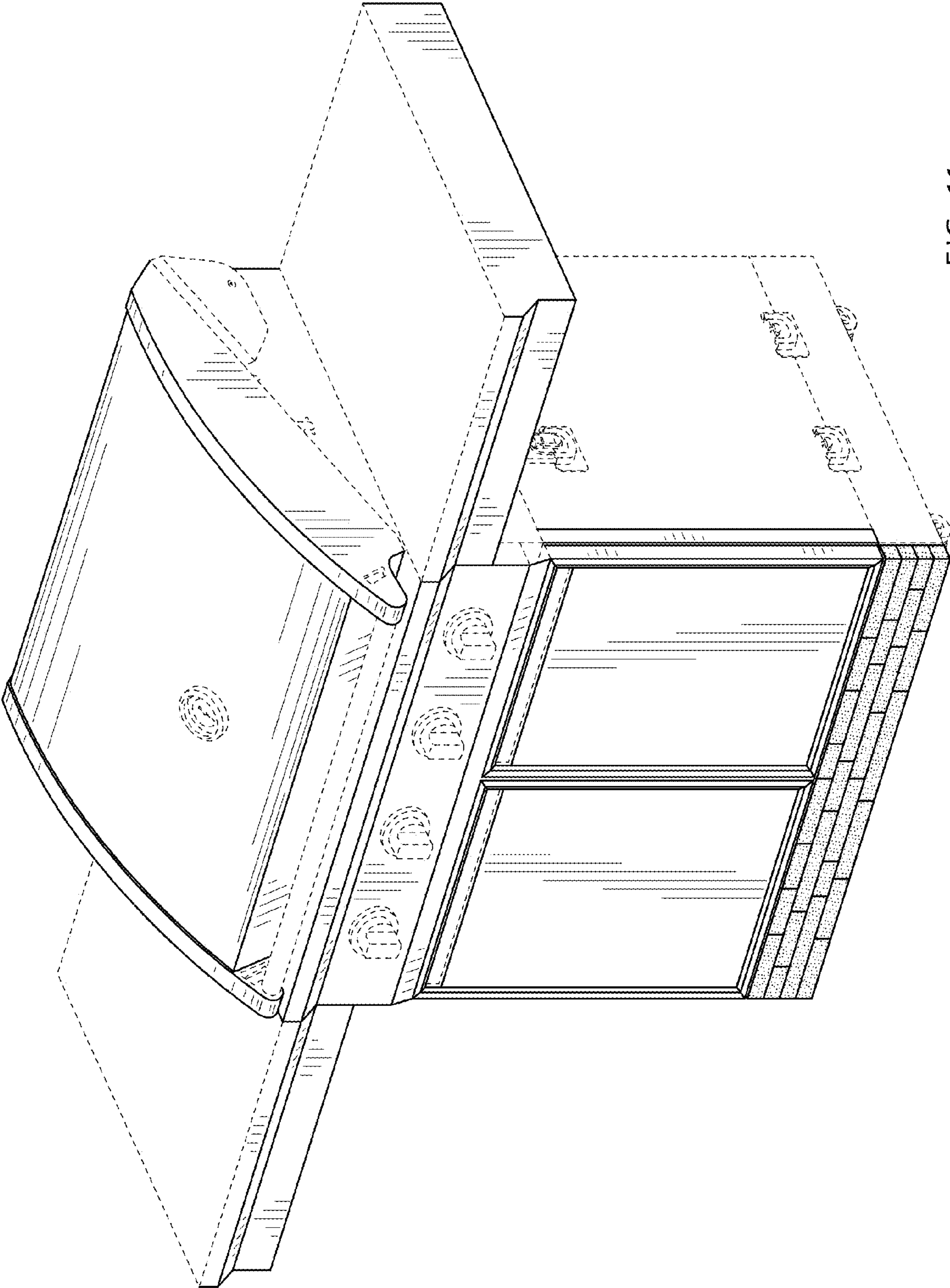

FIG. 11

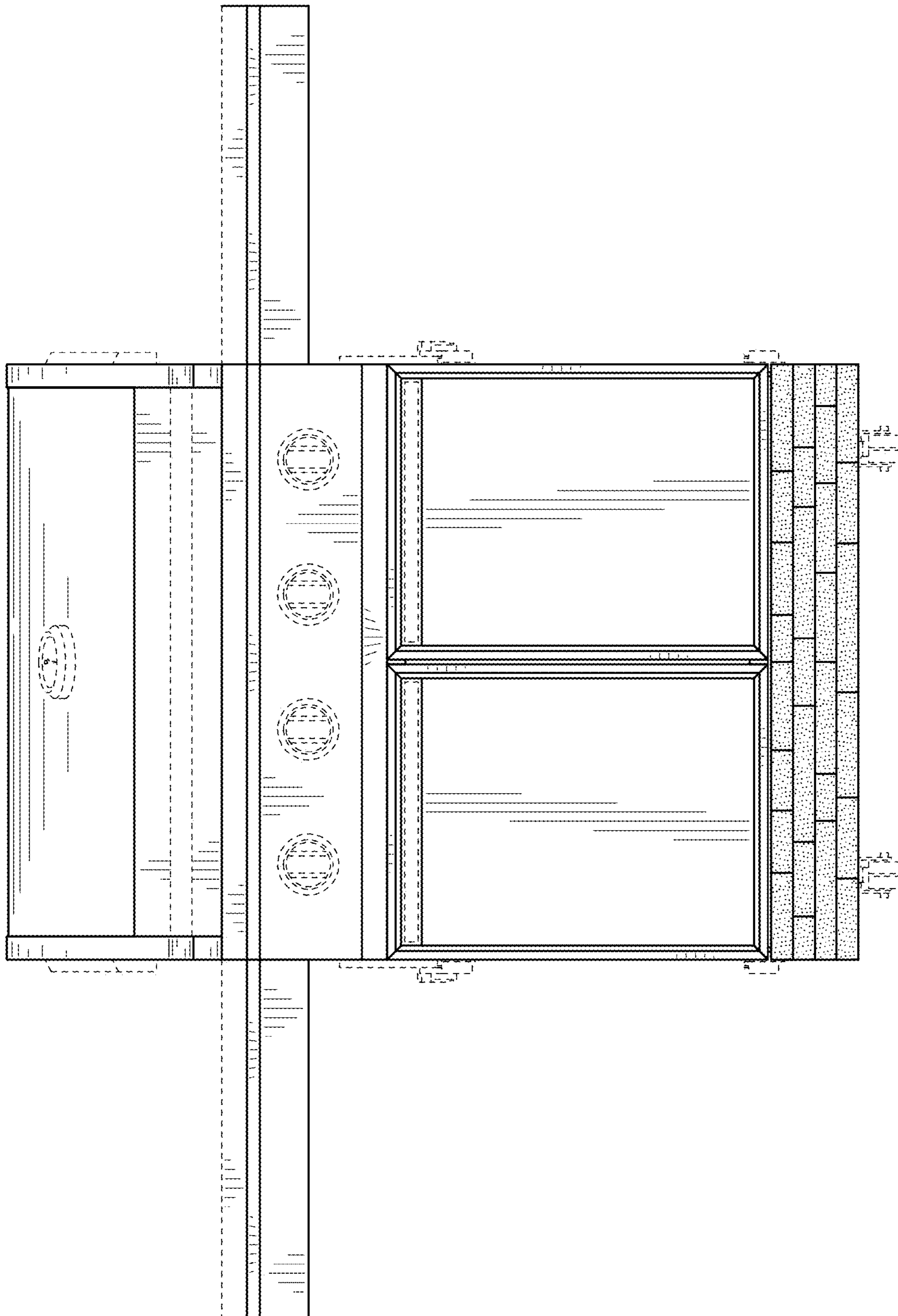

FIG. 12

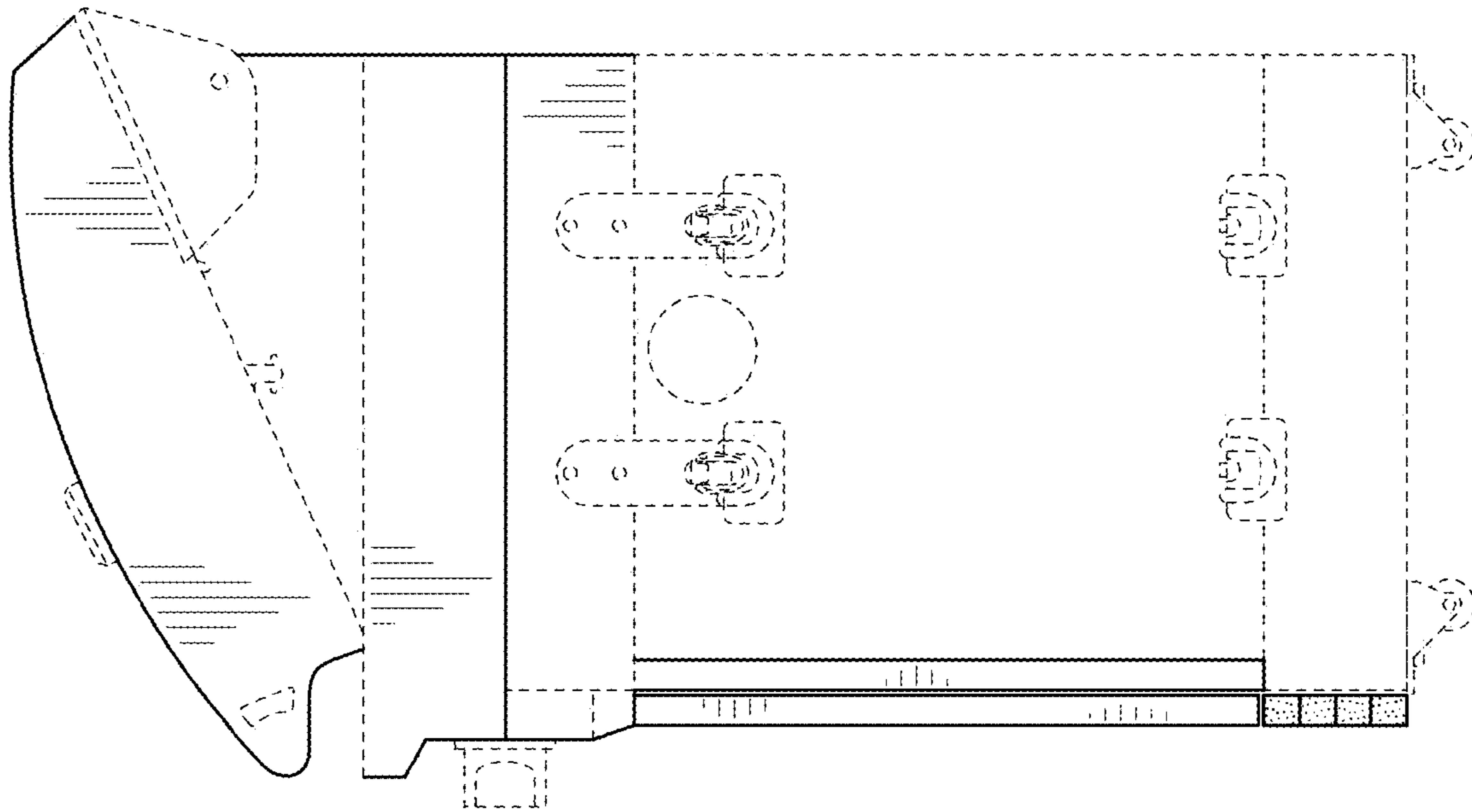

FIG. 13

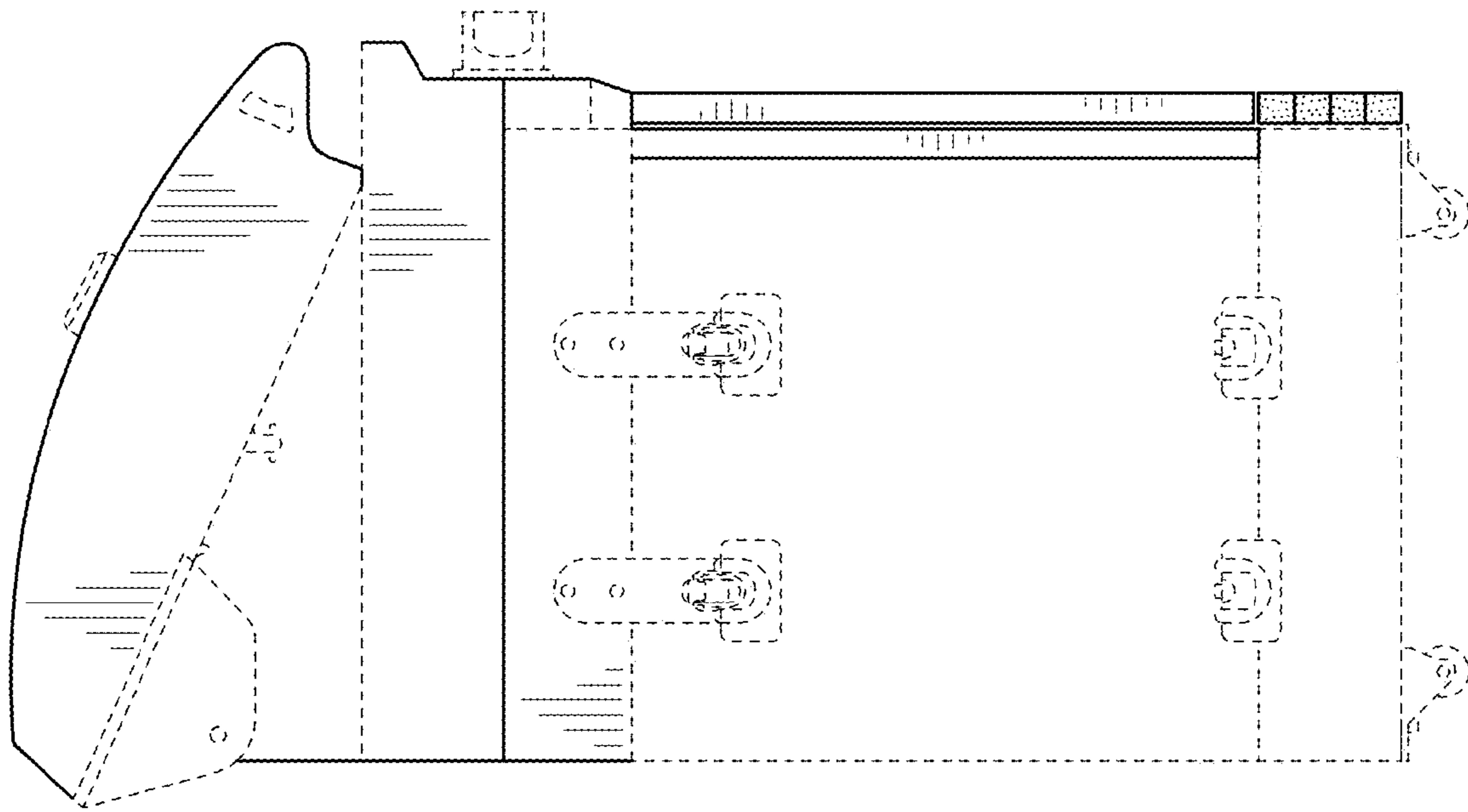

FIG. 14

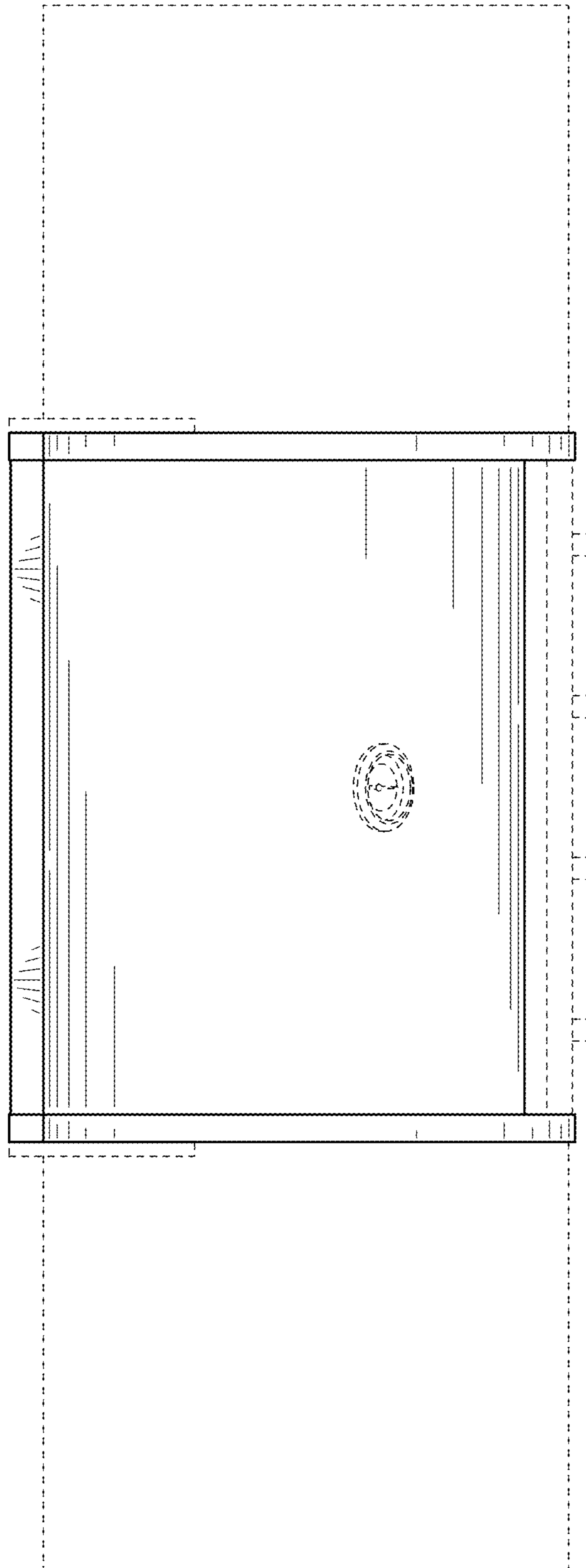

FIG. 15