



US00D928543S

(12) **United States Design Patent** (10) **Patent No.:** **US D928,543 S**
Jin (45) **Date of Patent:** **** Aug. 24, 2021**

(54) **PITCHER**
(71) Applicant: **Hangzhou Yingmaode Housewares Co., ltd., Zhejiang (CN)**
(72) Inventor: **Xinzuo Jin, Zhejiang (CN)**
(**) Term: **15 Years**
(21) Appl. No.: **29/718,615**
(22) Filed: **Dec. 26, 2019**
(51) **LOC (13) Cl.** **07-01**
(52) **U.S. Cl.**
USPC **D7/319; D7/318**
(58) **Field of Classification Search**
USPC D7/300, 300.1, 301-303, 312-321, 376, D7/378, 393-395, 396.1, 396.2, 397-401, D7/413, 598, 600, 601, 602, 619.1, 622, D7/629, 709
CPC A45F 3/16; A47G 19/12; A47G 19/127; A47G 19/14; A47G 19/16; A47G 19/22; A47G 19/30; A47G 2019/122; A47J 27/21; A47J 27/21008; A47J 27/2105; A47J 27/21058; A47J 27/21083; A47J 27/21183; A47J 27/21191; A47J 31/005; A47J 31/0642; A47J 31/54
See application file for complete search history.

D884,406 S * 5/2020 Krawczyk A47G 19/14 D7/312
2014/0246463 A1* 9/2014 Poul A47G 19/14 222/472
2018/0146814 A1* 5/2018 Liu A47J 31/4407

OTHER PUBLICATIONS

Design No. D1241810, Apr. 22, 2005—Japan Patent Office Publication Date—Jun. 13, 2005 Owner—Iwasakikogyo Ltd, Designer—Yoshihisa Iwasaki Yamatokoriyama WIPO, available at <https://www3.wipo.int/designdb/en/index.jsp> (Year: 2005).*
Design No. 305961939, Aug. 4, 2020—China National Intellectual Property Administration (CNIPA) Publication Date—Aug. 4, 2020 Owner—Hangzhou yingmaode household products Co Ltd, Designer—Jin Xinzuo WIPO, available at <https://www3.wipo.int/designdb/en/index.jsp> (Year: 2020).*

(Continued)

Primary Examiner — Mary Ann Calabrese
Assistant Examiner — Natalya M Rapundalo
(74) *Attorney, Agent, or Firm* — Rumit Ranjit Kanakia

(57) **CLAIM**

The ornamental design for a pitcher, as shown and described.

(56) **References Cited**

U.S. PATENT DOCUMENTS

D370,150 S * 5/1996 Huang D7/317
D624,348 S * 9/2010 Bodum D7/319
D688,909 S * 9/2013 Chapman D7/318
D720,174 S * 12/2014 Melzer D7/319
D766,044 S * 9/2016 Davis D7/589
10,420,432 B1 * 9/2019 Krawczyk A47J 41/0061
D863,858 S * 10/2019 Bodum A47J 31/4407 D7/317
D880,925 S * 4/2020 Saul A47J 41/0061 D7/317

DESCRIPTION

FIG. 1 is a front elevational view of a pitcher showing my new design;
FIG. 2 is a rear elevational view thereof;
FIG. 3 is a left side view thereof;
FIG. 4 is a right side view thereof;
FIG. 5 is a top plan view thereof;
FIG. 6 is a bottom plan view thereof; and,
FIG. 7 is a perspective view thereof.

1 Claim, 7 Drawing Sheets

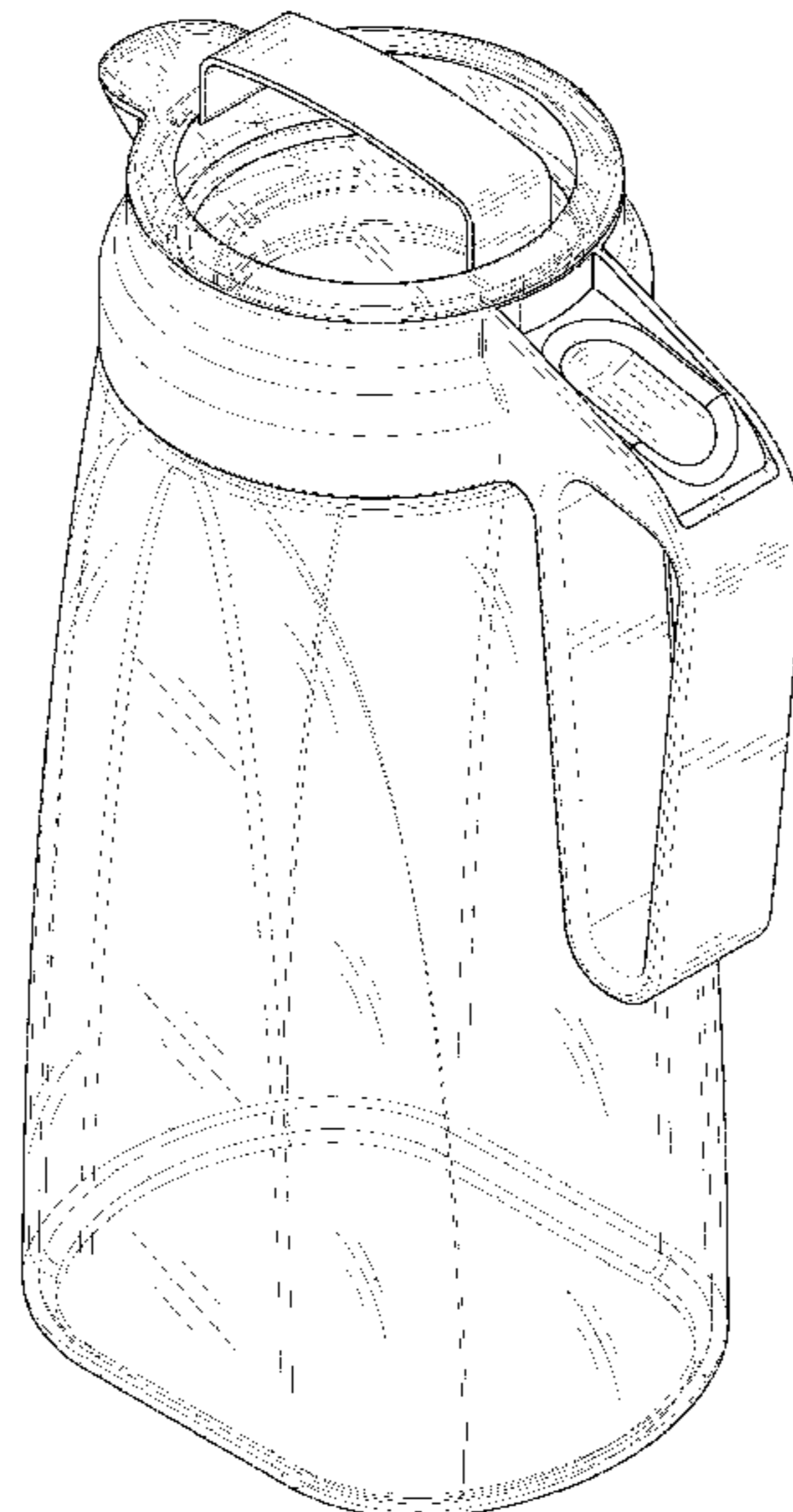

(56)

References Cited

OTHER PUBLICATIONS

Goodful Airtight Cold Brew Iced Coffee Maker, first available Feb. 14, 2020, Amazon, [online], [site visited Jun. 2, 2021], Available from internet URL: <https://www.amazon.com/Goodful-Shatterproof-Construction-Leak-Proof-Stainless/dp/B084TN9R3C> (Year: 2020).*

Eco-friendly BPA Free Plastic Iced Cold Brew Coffee Maker, Alibaba, [online], [site visited Jun. 2, 2021], Available from internet URL: https://www.alibaba.com/product-detail/Eco-friendly-BPA-Free-Plastic-Iced_1600073012318.html (Year: 2021).*

* cited by examiner

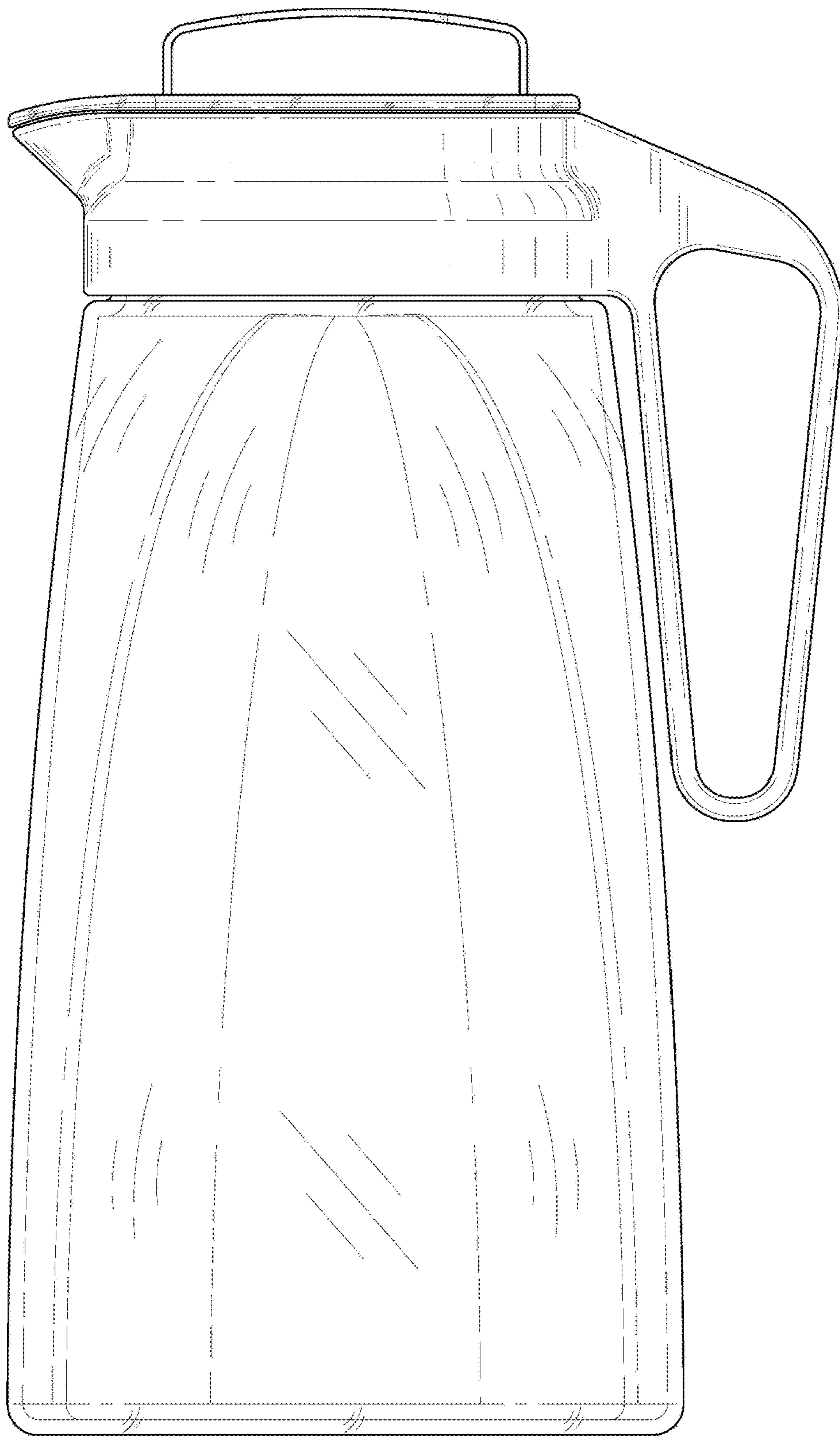

Fig. 1

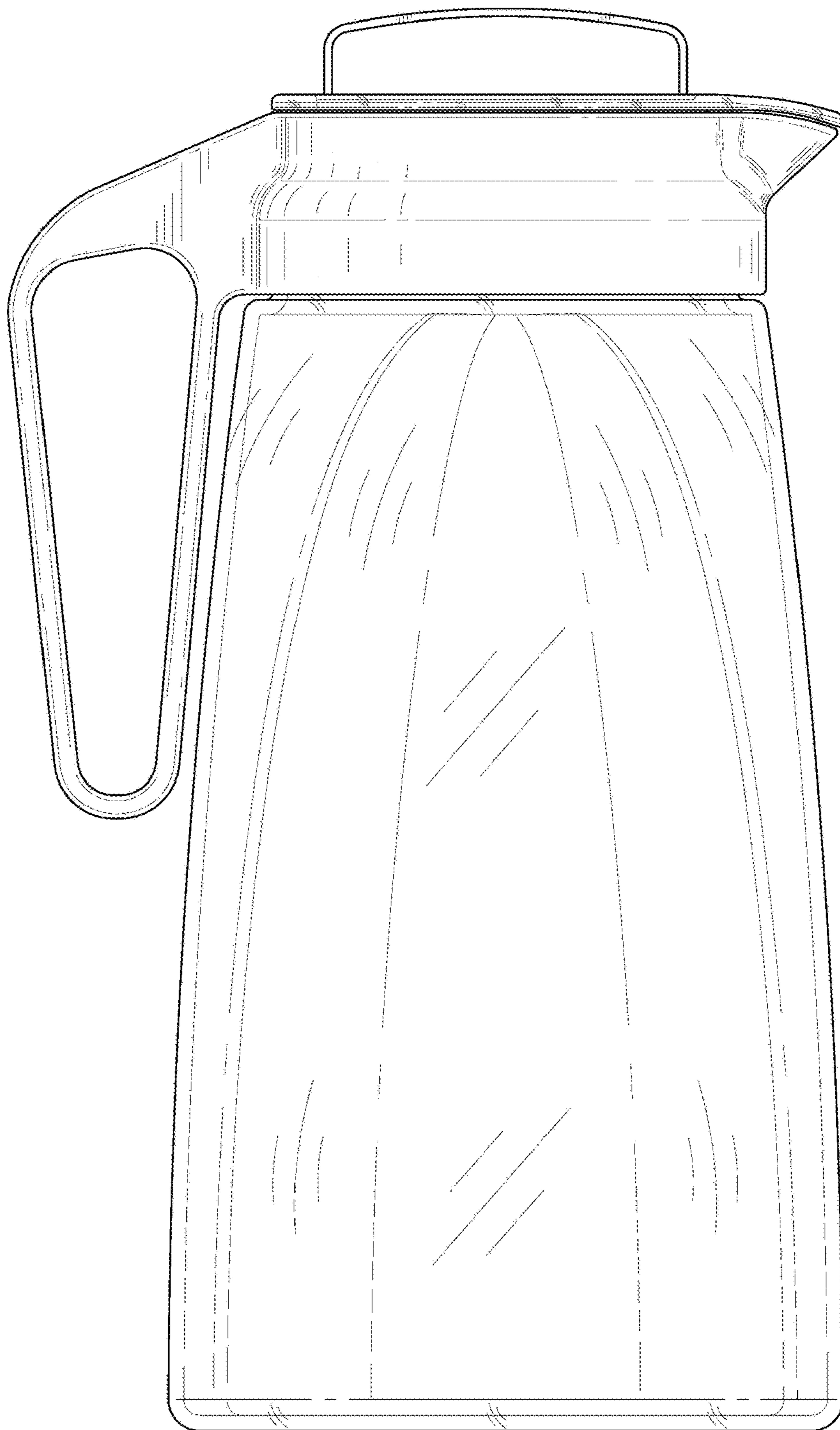

Fig. 2

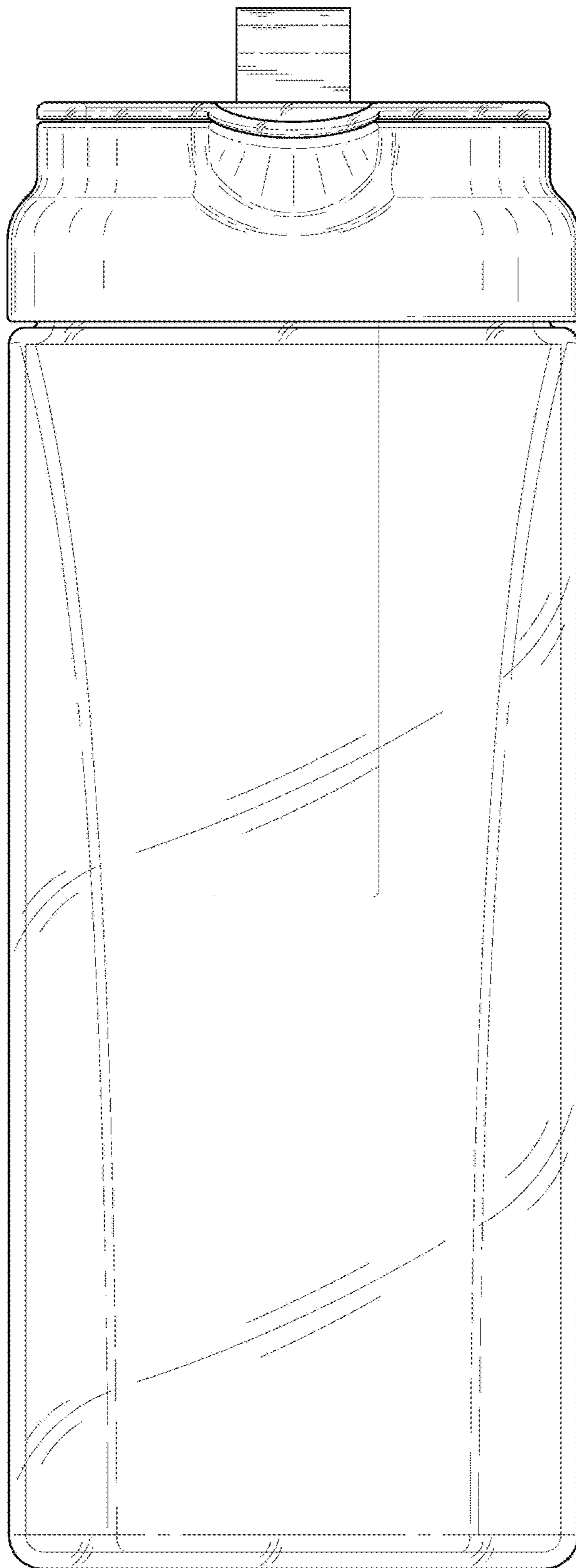

Fig.3

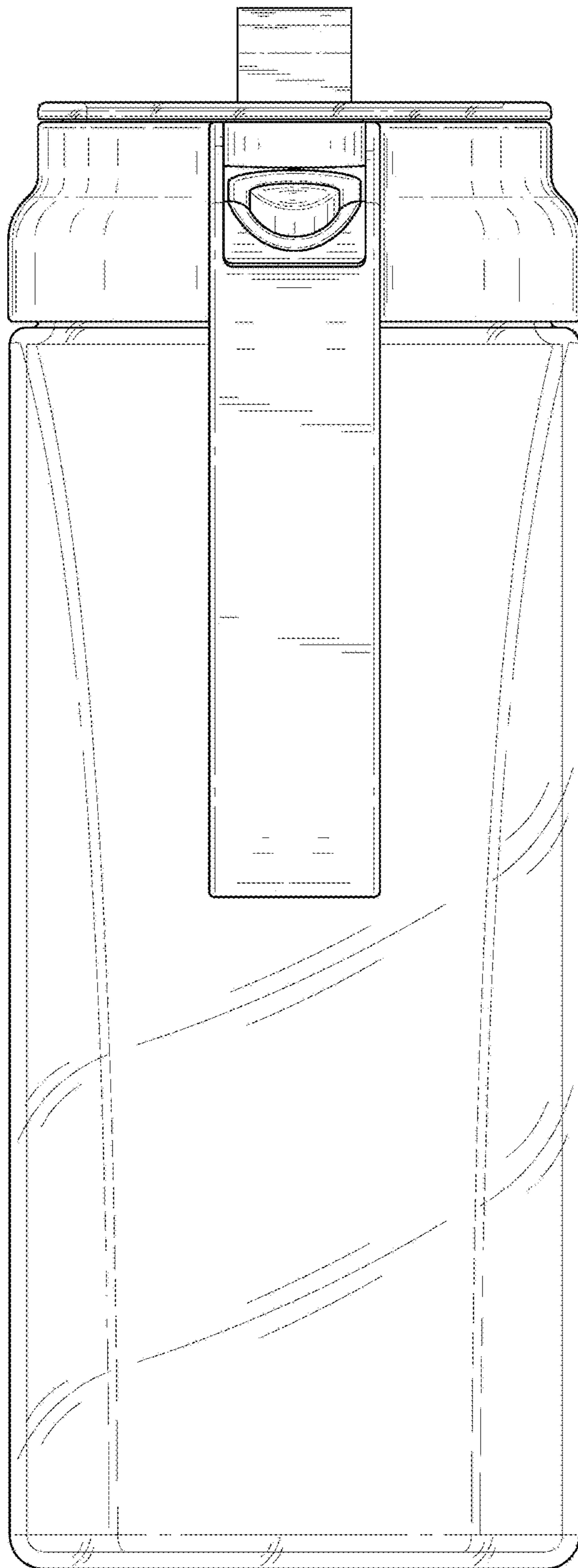

Fig. 4

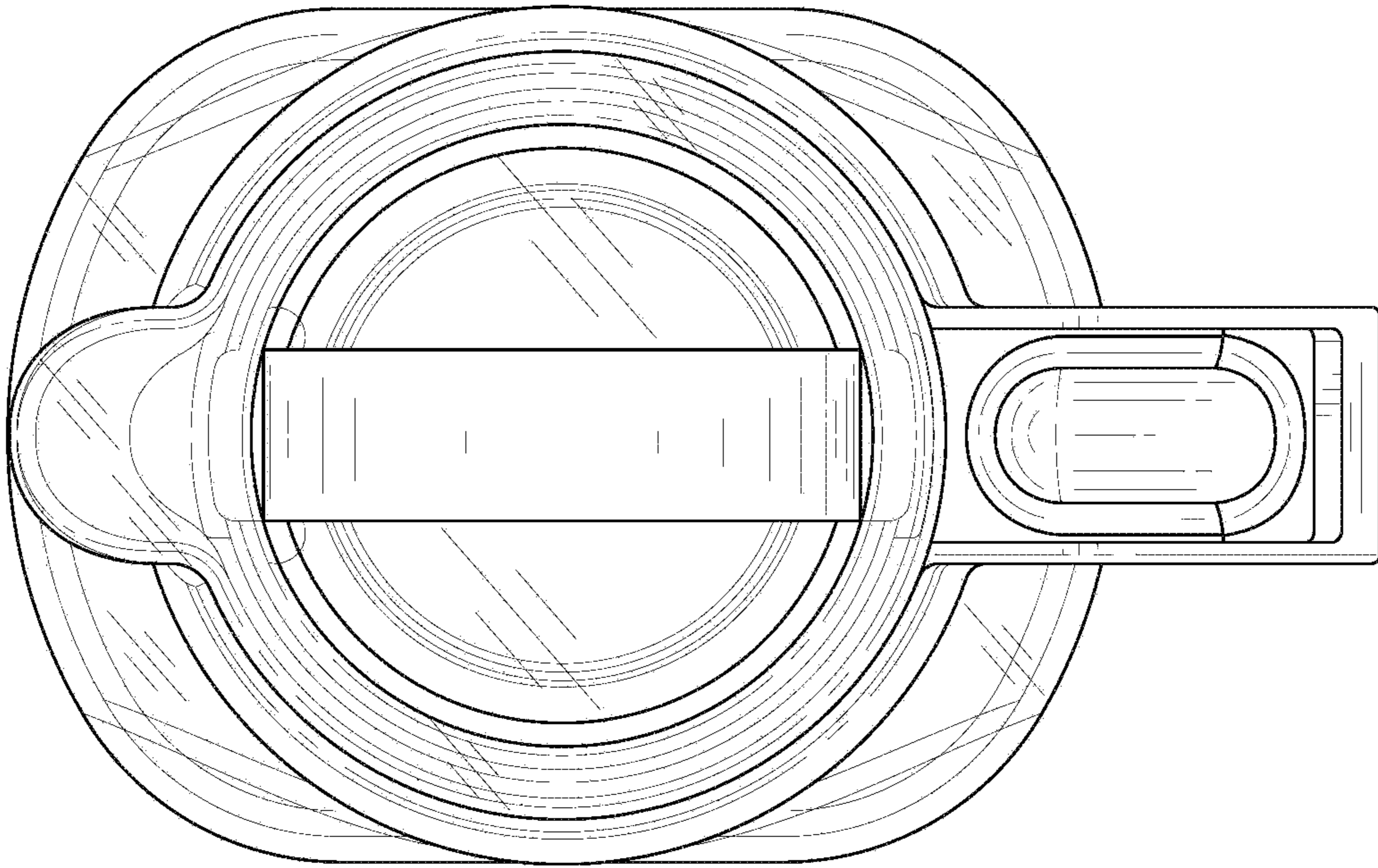

Fig.5

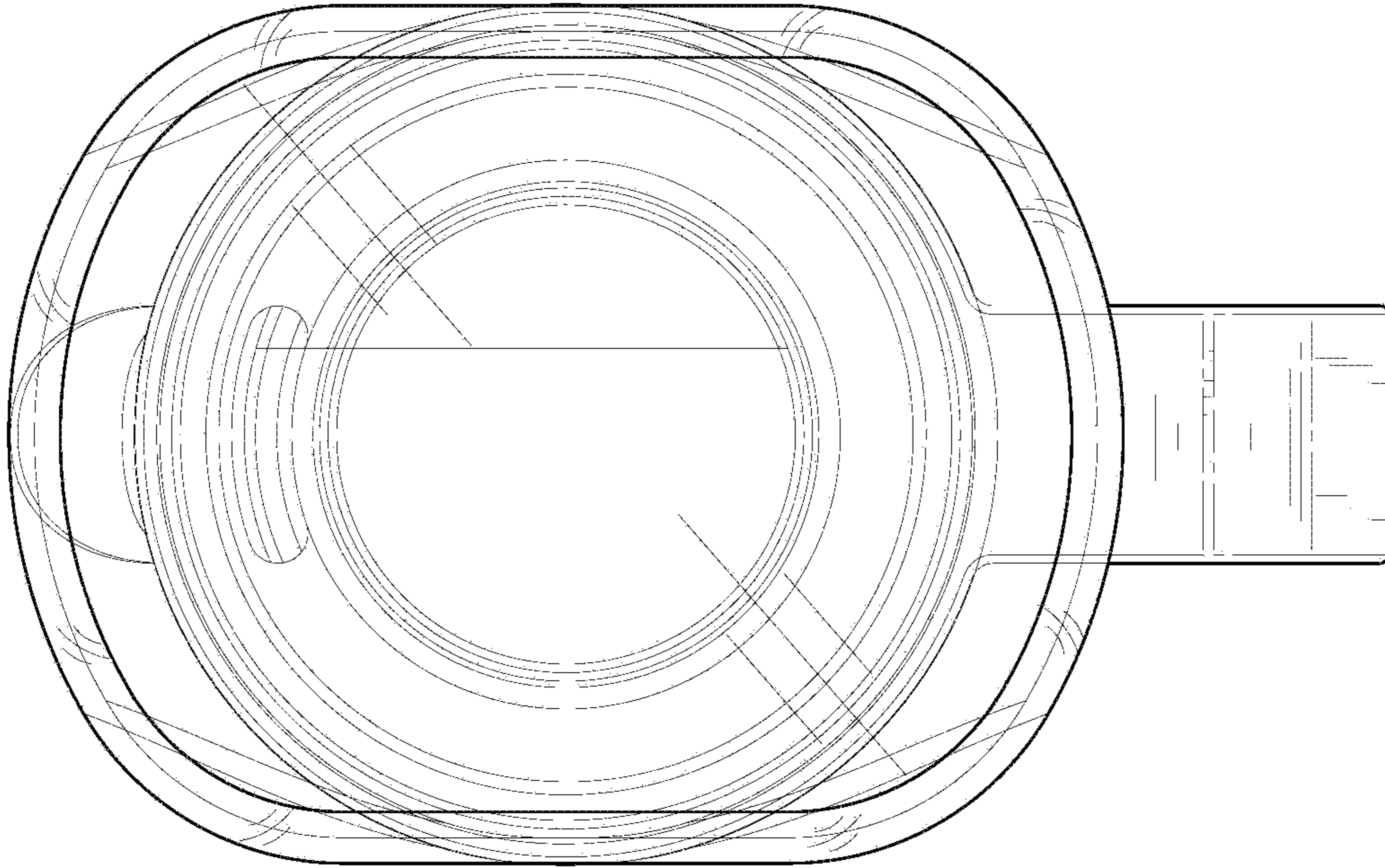

Fig. 6



Fig. 7