

US00D928539S

(12) **United States Design Patent**
Dunne et al.

(10) **Patent No.:** **US D928,539 S**

(45) **Date of Patent:** **** Aug. 24, 2021**

(54) **DISPLAY FOR FRAGRANCE AND COSMETIC SAMPLER**

(71) Applicant: **CHANEL, INC.**, New York, NY (US)

(72) Inventors: **Kelly Dunne**, New York, NY (US);
Olivia Eddy, New York, NY (US);
Wendy Burns, New York, NY (US);
Robin Kramer, New York, NY (US)

(73) Assignee: **CHANEL, INC.**, New York, NY (US)

(**) Term: **15 Years**

(21) Appl. No.: **29/677,788**

(22) Filed: **Jan. 23, 2019**

(51) **LOC (13) Cl.** **20-02**

(52) **U.S. Cl.**
USPC **D6/682**

(58) **Field of Classification Search**
USPC D6/672, 673, 674, 674.1, 678, 682, 557,
D6/563; D7/628; D9/661, 662, 663,
D9/455; D27/119

CPC A41G 1/00; B65D 85/00; B65D 81/365;
Y10S 206/823; A47F 5/00; A47F 7/00;
A47F 2007/0092; A47F 7/02; A47F 7/28;
A47F 7/286

See application file for complete search history.

(56) **References Cited**

U.S. PATENT DOCUMENTS

- 1,886,429 A * 11/1932 Saeks A41G 1/006
239/60
- 2,204,037 A * 6/1940 Fernbach B65D 85/00
428/23
- D122,392 S * 9/1940 Douglas et al. D9/455
- D135,028 S * 2/1943 Flaster et al. D9/455
- D135,487 S * 4/1943 Botham et al. D9/455
- D146,087 S * 12/1946 Matuzoff et al. D6/674

- D149,488 S * 5/1948 Halpern et al. D6/681.3
- D195,222 S * 5/1963 Heiney et al. D6/674
- D196,254 S * 9/1963 Dwyer et al. D26/127
- D210,921 S * 4/1968 Downs et al. D6/674
- D226,152 S * 1/1973 Dowding et al. D7/625
- 4,082,872 A * 4/1978 Hughes A41G 1/00
131/231
- D256,219 S * 8/1980 Miyazaki 150/150
- D366,946 S * 2/1996 Hoak D26/7
- D405,359 S * 2/1999 Thierry D9/661
- 5,947,582 A * 9/1999 Huang A41G 1/005
362/122
- D417,887 S * 12/1999 Coipel D11/117
- D433,934 S * 11/2000 Gatti D9/662
- D470,621 S * 2/2003 Cheng D26/127
- D484,069 S * 12/2003 Robinson D11/80
- D496,786 S * 10/2004 Wolf D3/215
- D500,344 S * 12/2004 Davies D20/29

(Continued)

Primary Examiner — Steven J Czyn

(74) *Attorney, Agent, or Firm* — Fross, Zelnick, Lehrman & Zissu, PC; Charles T. J. Weigell, Esq.

(57) **CLAIM**

The ornamental design for a display for fragrance and cosmetic sampler, as shown and described.

DESCRIPTION

FIG. 1 is a top view of the display for fragrance and cosmetic sampler showing our new design;

FIG. 2 is a bottom view thereof;

FIG. 3 is a front view thereof;

FIG. 4 is a left side view thereof (with the right side being a mirror image);

FIG. 5 is a back side view thereof; and,

FIG. 6 is a perspective view of the display for fragrance and cosmetic sampler shown in use with the environment attached.

The broken lines depict environment that form no part of the claimed design.

1 Claim, 6 Drawing Sheets

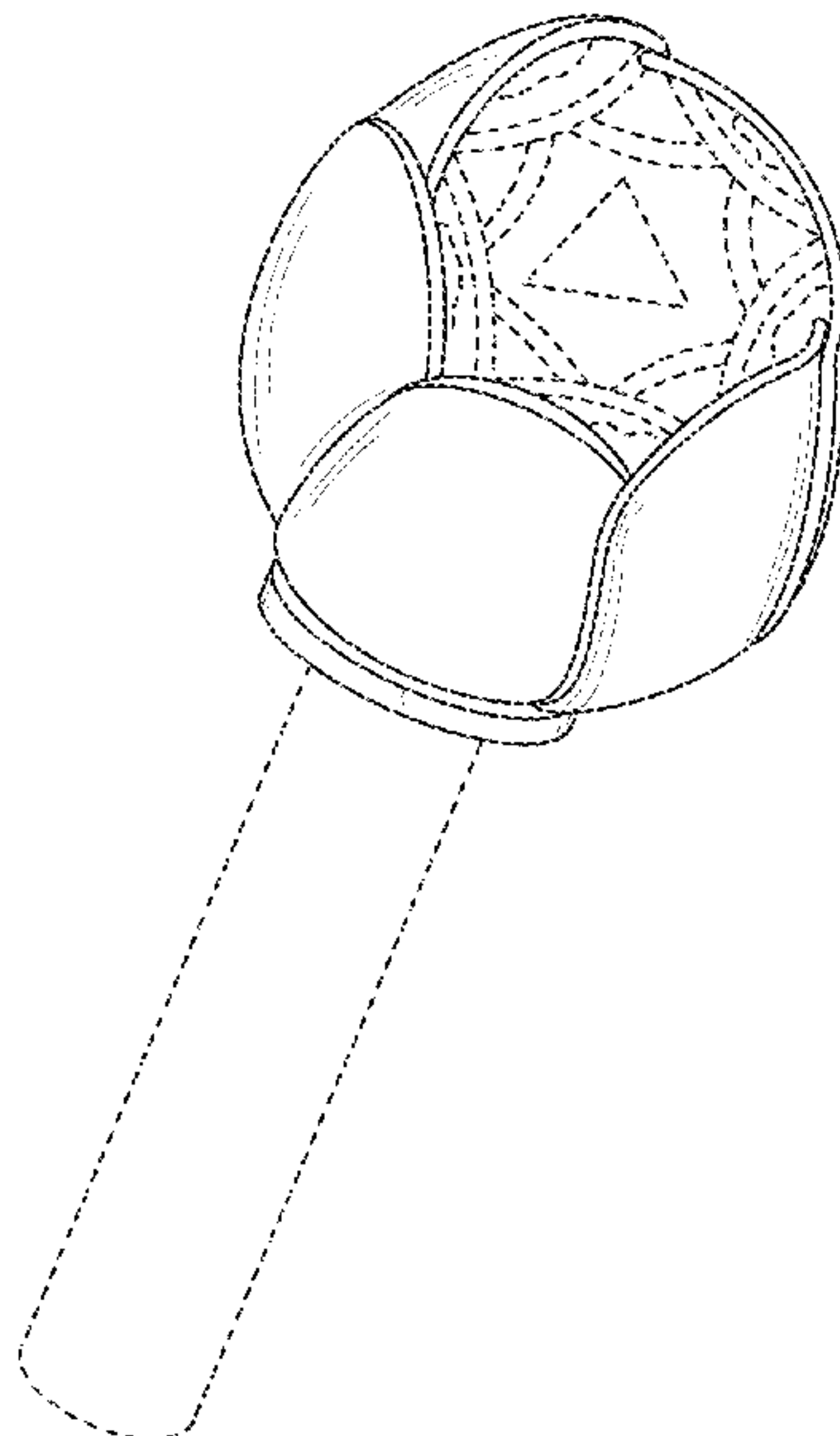

(56)

References Cited

U.S. PATENT DOCUMENTS

| | | | | | | |
|----------|---|---|---------|----------------|-------|----------|
| D507,360 | S | * | 7/2005 | Yuen | | D26/26 |
| D540,068 | S | * | 4/2007 | Zhang | | D6/672 |
| D551,785 | S | * | 9/2007 | Montgomery | | D26/26 |
| D588,307 | S | * | 3/2009 | Lambertz | | D27/119 |
| D630,791 | S | * | 1/2011 | Wanders | | D26/127 |
| D636,233 | S | * | 4/2011 | Anton Villa | | D7/587 |
| D645,309 | S | * | 9/2011 | Anton Villa | | D7/587 |
| D683,222 | S | * | 5/2013 | McGregor | | D9/661 |
| D698,102 | S | * | 1/2014 | Muhr | | D30/124 |
| D758,214 | S | * | 6/2016 | Gueit | | D10/36 |
| D780,434 | S | * | 3/2017 | Daniels | | D2/976 |
| D784,729 | S | * | 4/2017 | Lee | | D6/563 |
| D786,633 | S | * | 5/2017 | Riffe | | D8/1 |
| D790,296 | S | * | 6/2017 | Riffe | | D8/1 |
| D801,578 | S | * | 10/2017 | Kefer | | D27/119 |
| D802,916 | S | * | 11/2017 | Koutsolioutsos | | D3/232 |
| D819,895 | S | * | 6/2018 | Smith | | D30/125 |
| D869,771 | S | * | 12/2019 | De Lataillade | | D28/91.1 |
| D877,736 | S | * | 3/2020 | Ouyang | | D14/358 |

* cited by examiner

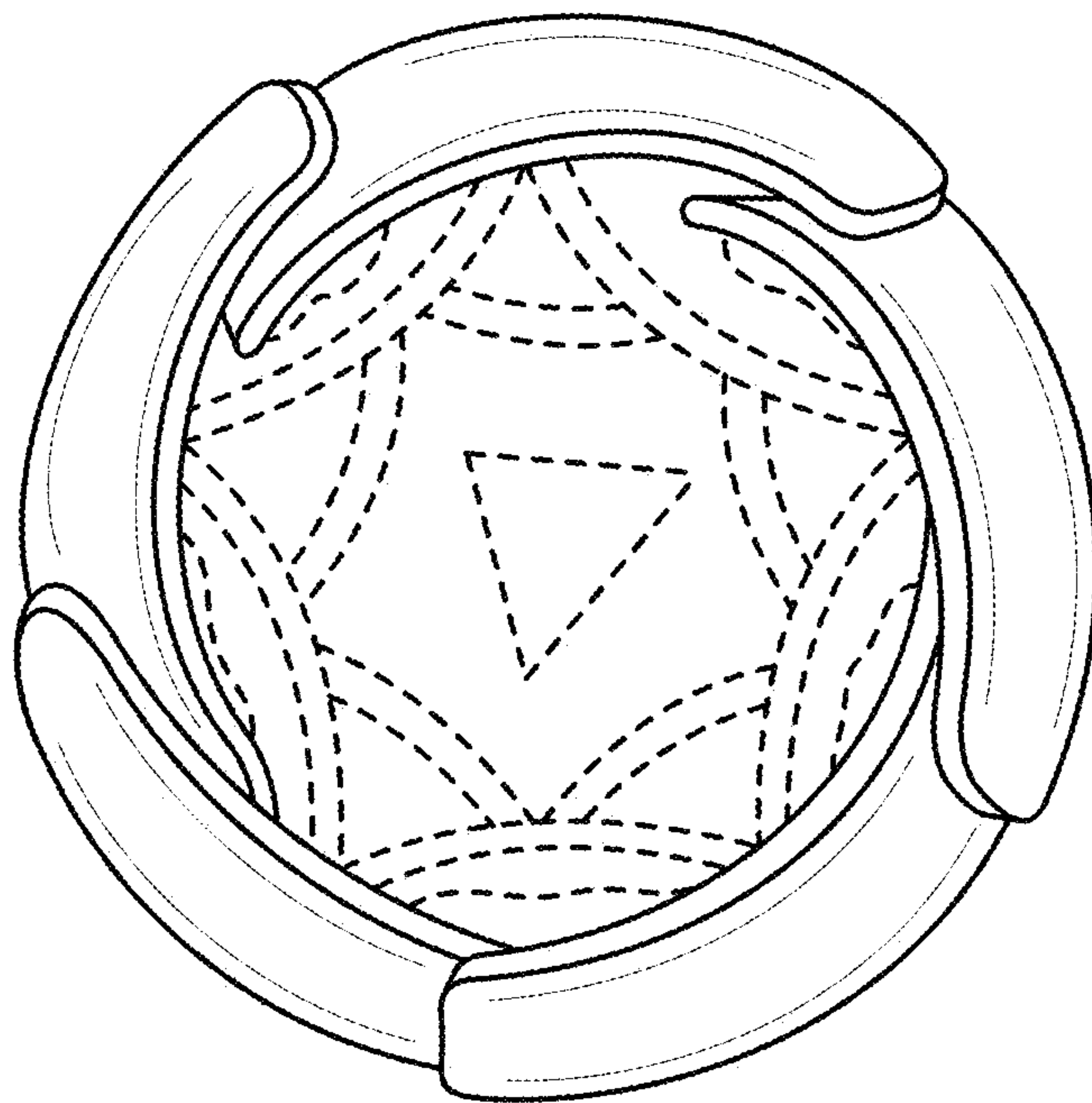

FIG. 1

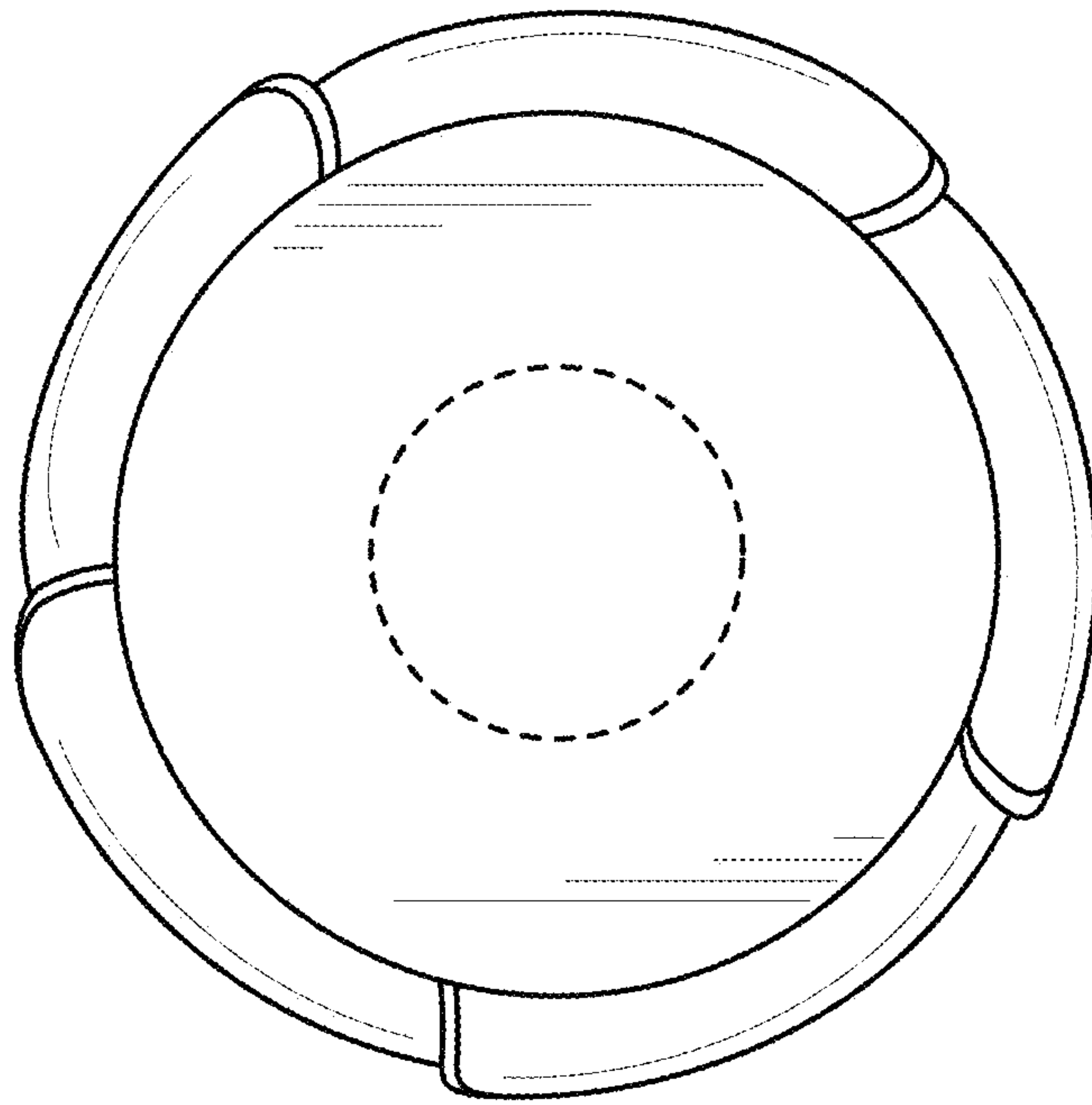

FIG. 2

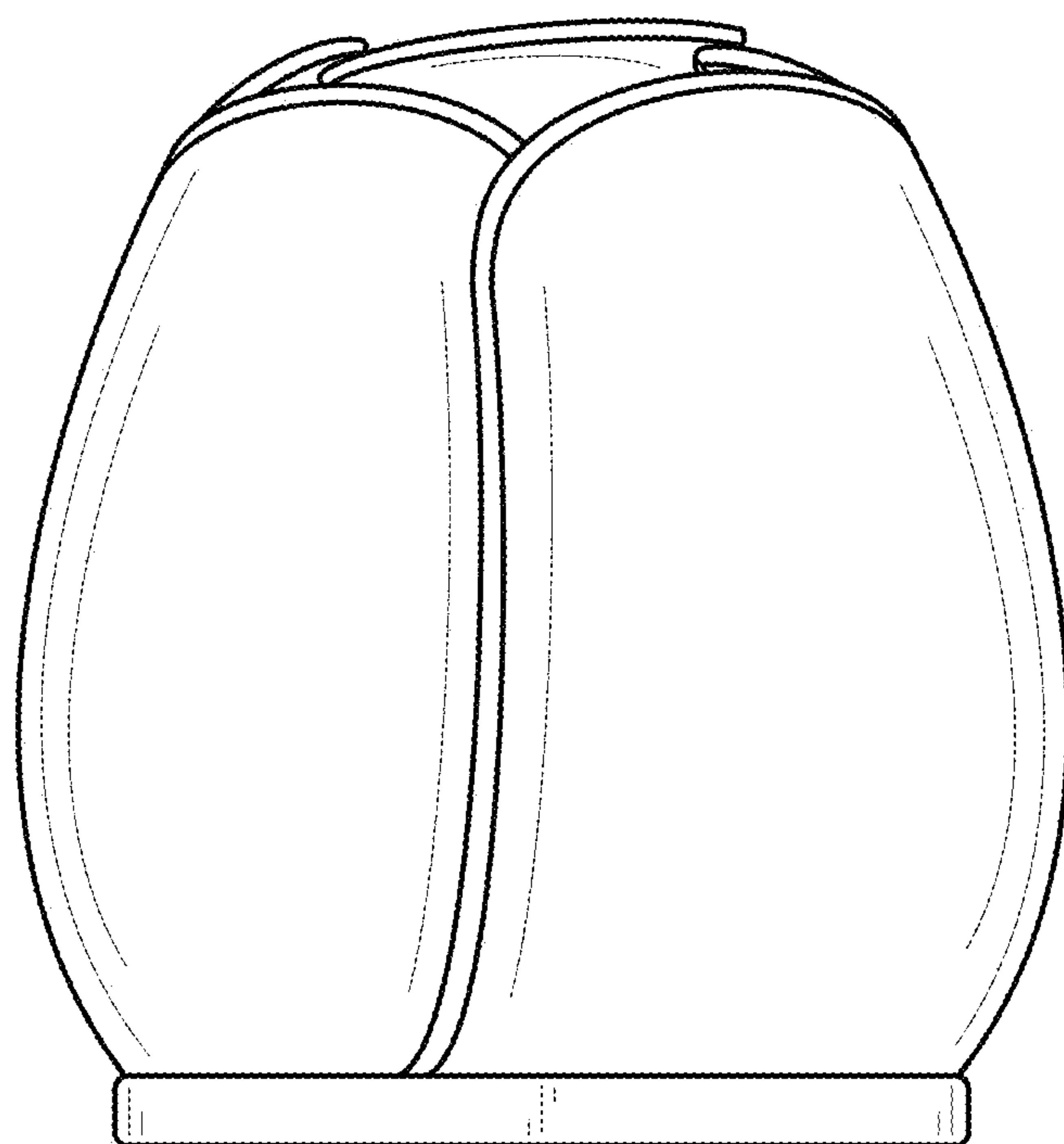

FIG. 3

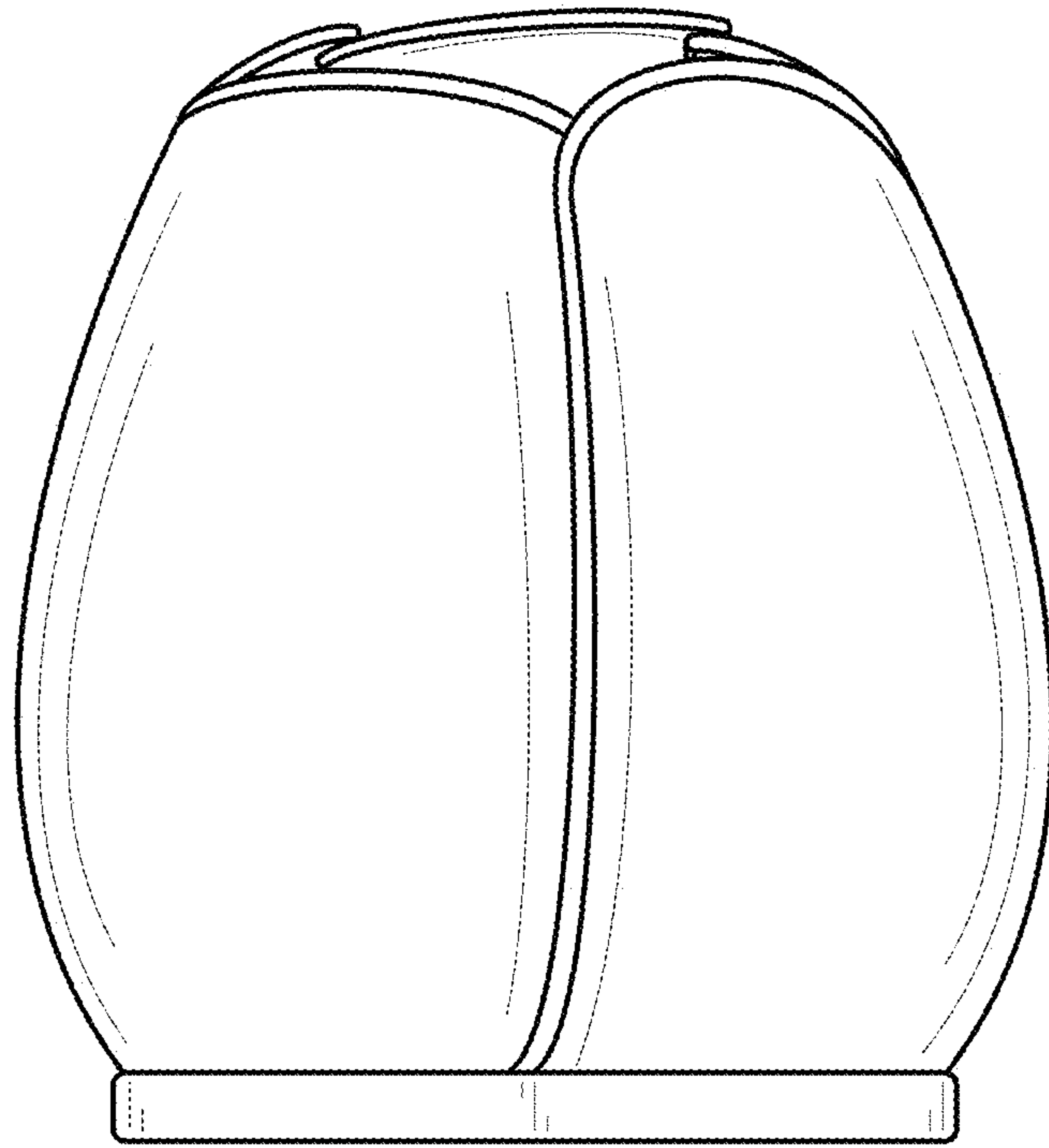

FIG. 4

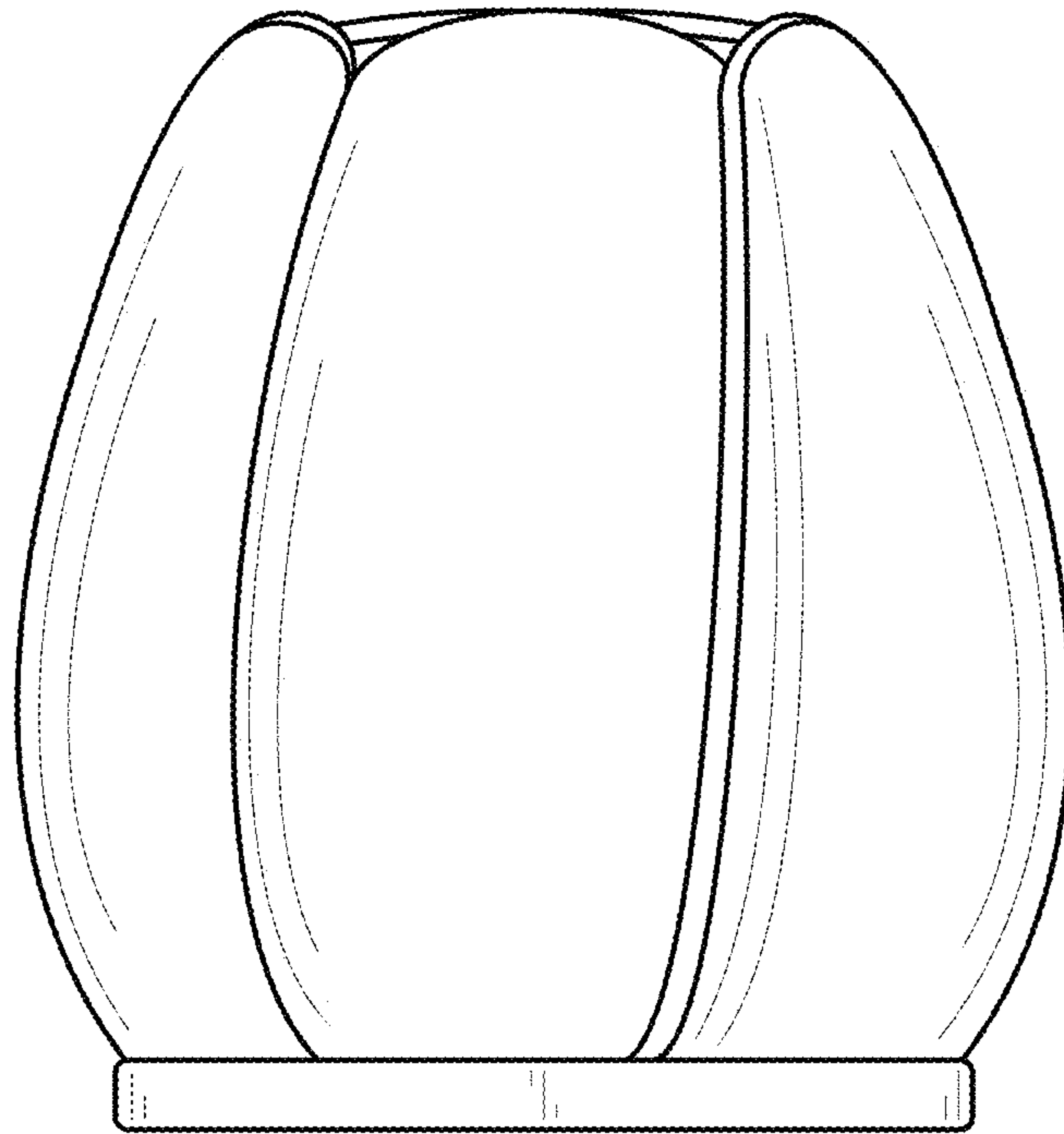

FIG. 5

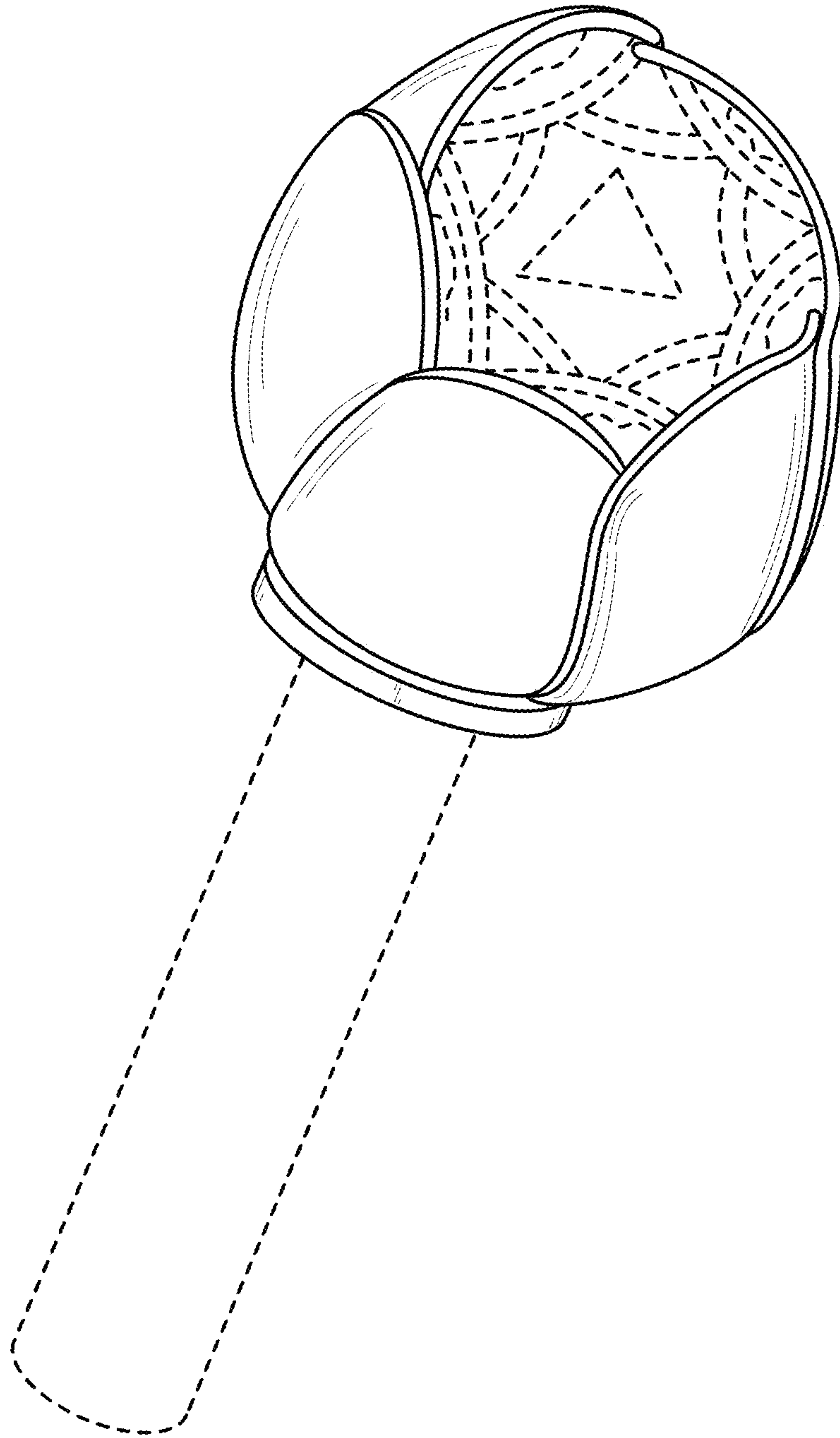

FIG. 6