



US00D928507S

(12) **United States Design Patent** (10) **Patent No.:** **US D928,507 S**
Daubmeier (45) **Date of Patent:** **** Aug. 24, 2021**

(54) **HANDBAG**

FOREIGN PATENT DOCUMENTS

- (71) Applicant: **LOUIS VUITTON MALLETIER**, Paris (FR)
- (72) Inventor: **Sigrid Daubmeier**, Paris (FR)
- (73) Assignee: **Louis Vuitton Malletier**, Paris (FR)
- (**) Term: **15 Years**
- (21) Appl. No.: **29/698,224**
- (22) Filed: **Jul. 15, 2019**

DE	402011002204-0003	8/2011
EM	003298777-0001	7/2016
EM	003429034-0001	10/2016
EM	04720316-0004	2/2018
EM	004720316-0005	2/2018
ES	9519722-01	7/2014
ES	9519722-03	7/2014
FR	935726-002	12/1996
FR	991855-001	7/1999
FR	20165291-001	12/2016
IO	015398	2/1990
IT	FI2012O000009	9/2012
KR	3001157540000	7/1991
KR	300917186000	8/2017

(30) **Foreign Application Priority Data**

Jan. 16, 2019 (FR) 2019-0216

- (51) **LOC (13) Cl.** **03-01**
- (52) **U.S. Cl.**
USPC **D3/242**
- (58) **Field of Classification Search**
USPC D3/232-233, 240-243, 245-246, 276
CPC A45C 1/024; A45C 3/06; A45C 3/08
See application file for complete search history.

* cited by examiner

Primary Examiner — Michelle E. Wilson
(74) *Attorney, Agent, or Firm* — Fross Zelnick Lehrman & Zissu, P.C.; Charles T. J. Weigell, Esq.

(57) **CLAIM**

The ornamental design for a handbag, as shown and described.

DESCRIPTION

(56) **References Cited**

U.S. PATENT DOCUMENTS

D396,004 S *	7/1998	Srinual	D3/294
D414,037 S *	9/1999	Akaike	D3/272
D415,614 S *	10/1999	Akaike	D3/272
D467,423 S *	12/2002	Wolf	D3/276
D570,114 S *	6/2008	Netz	D3/294
D643,623 S *	8/2011	Chin	D3/272
D758,070 S *	6/2016	Frohlich	D3/232
D815,430 S *	4/2018	Nair	D3/242

FIG. 1 is a front perspective view of my handbag showing my new design;
FIG. 2 is a front view thereof;
FIG. 3 is a back view thereof;
FIG. 4 is a right side view thereof;
FIG. 5 is a left side view thereof;
FIG. 6 is a top view thereof; and,
FIG. 7 is a bottom view thereof.

1 Claim, 7 Drawing Sheets

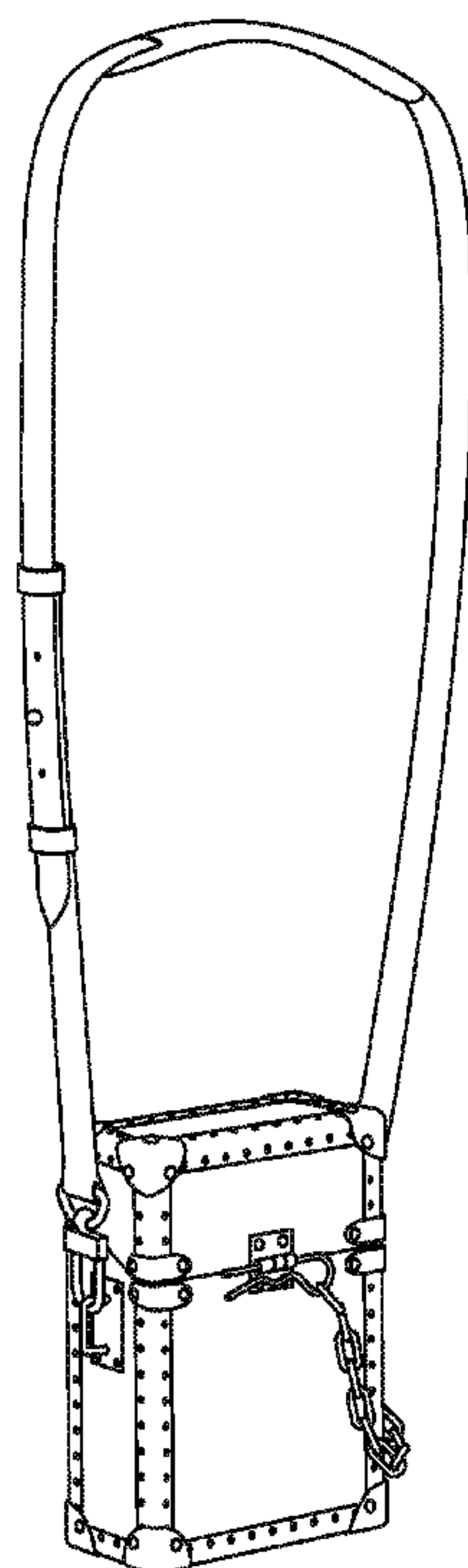

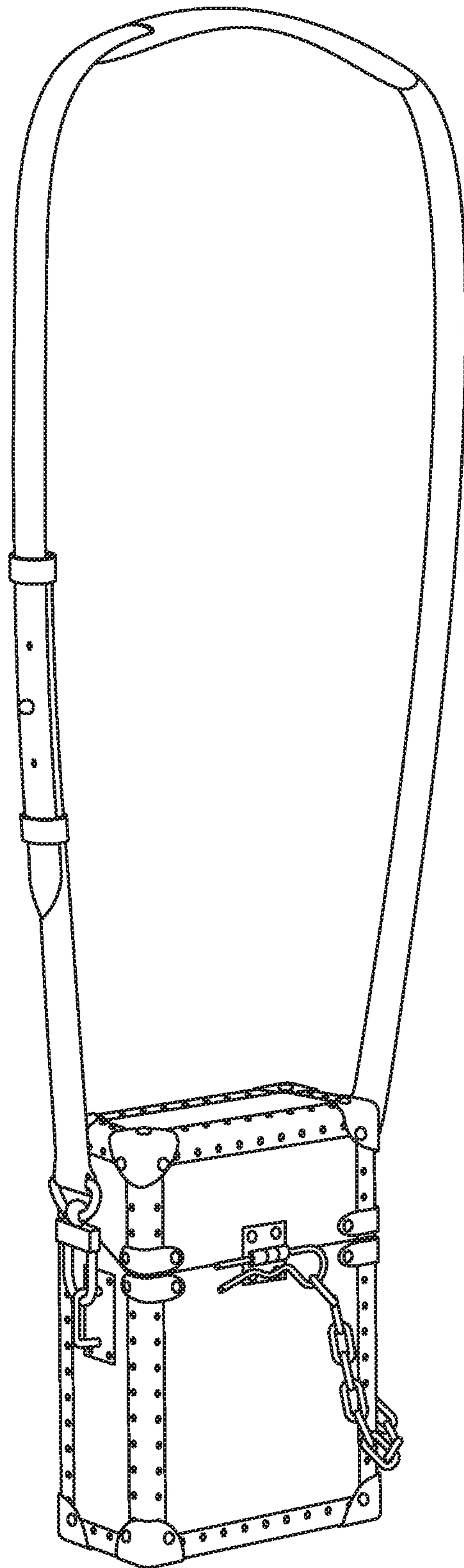

FIG. 1

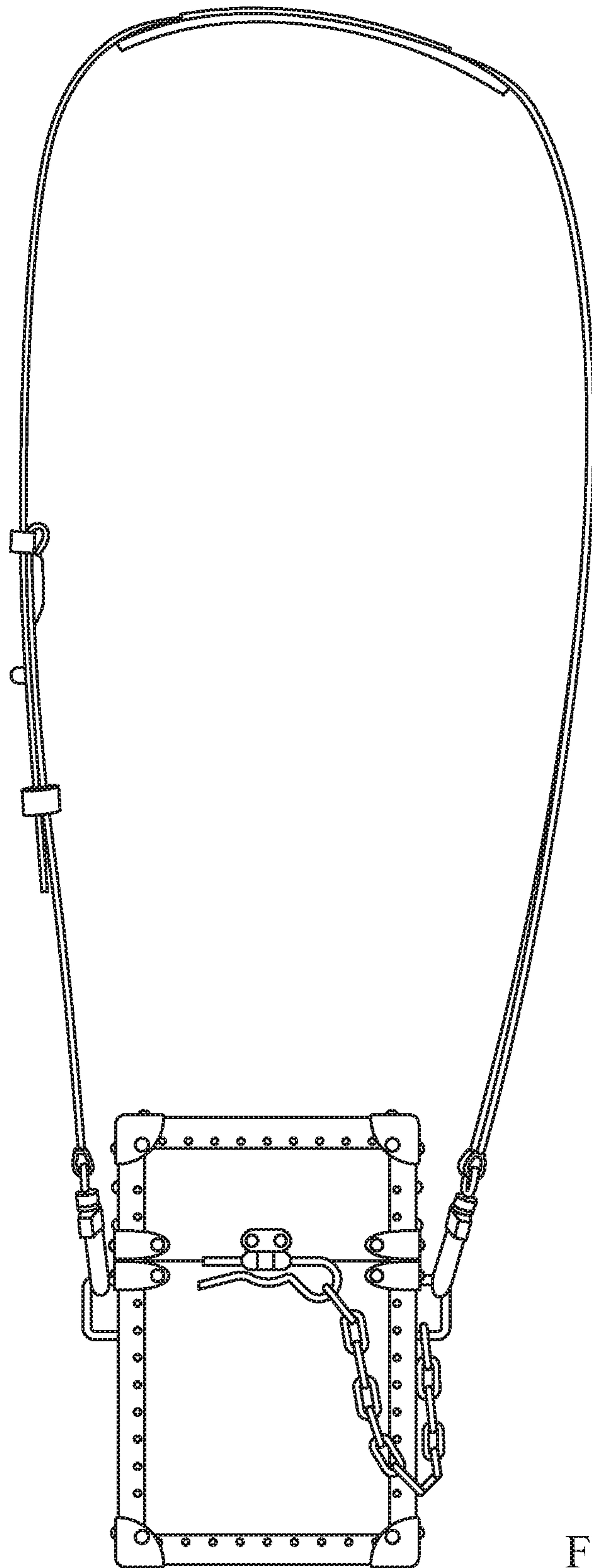

FIG. 2

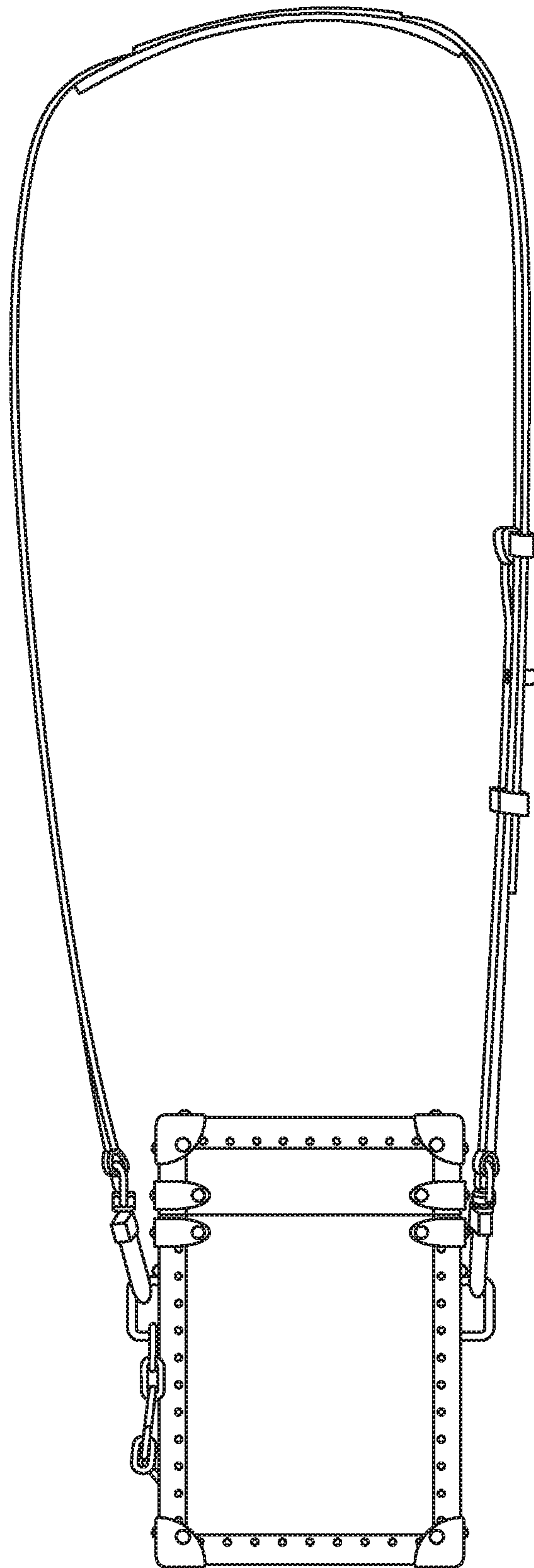

FIG. 3

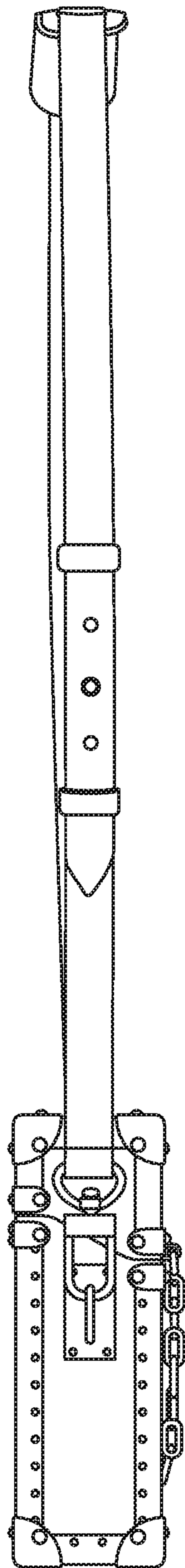

FIG. 4

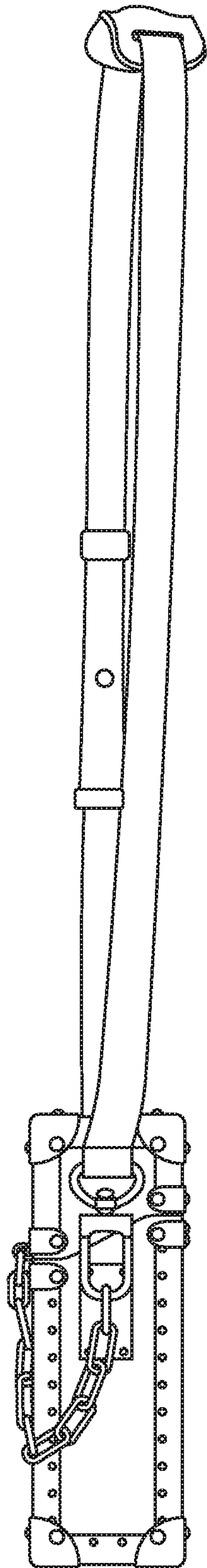

FIG. 5

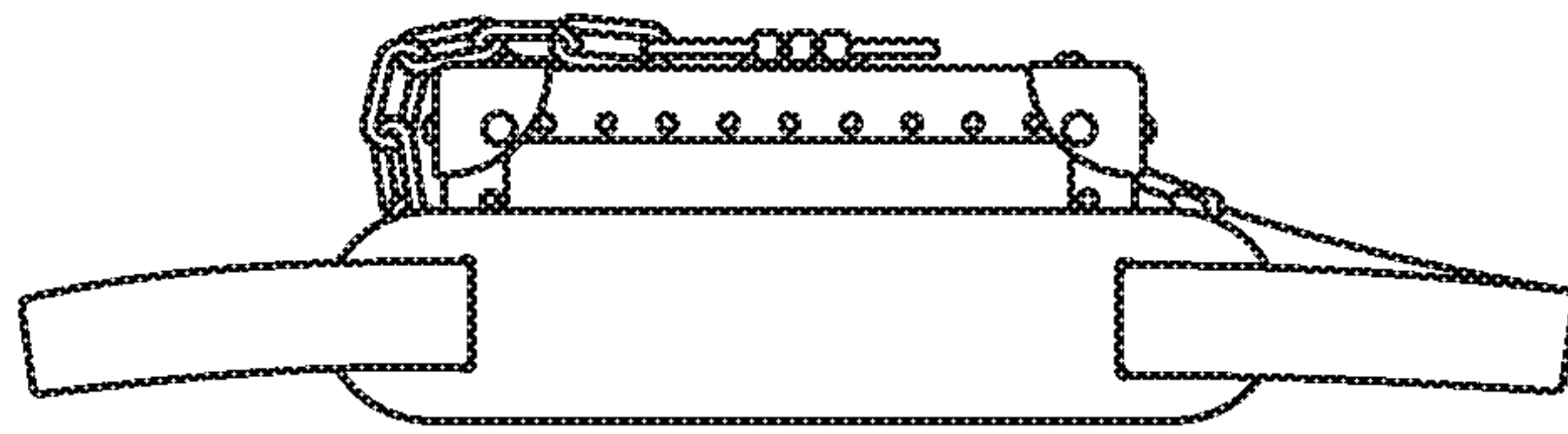

FIG. 6

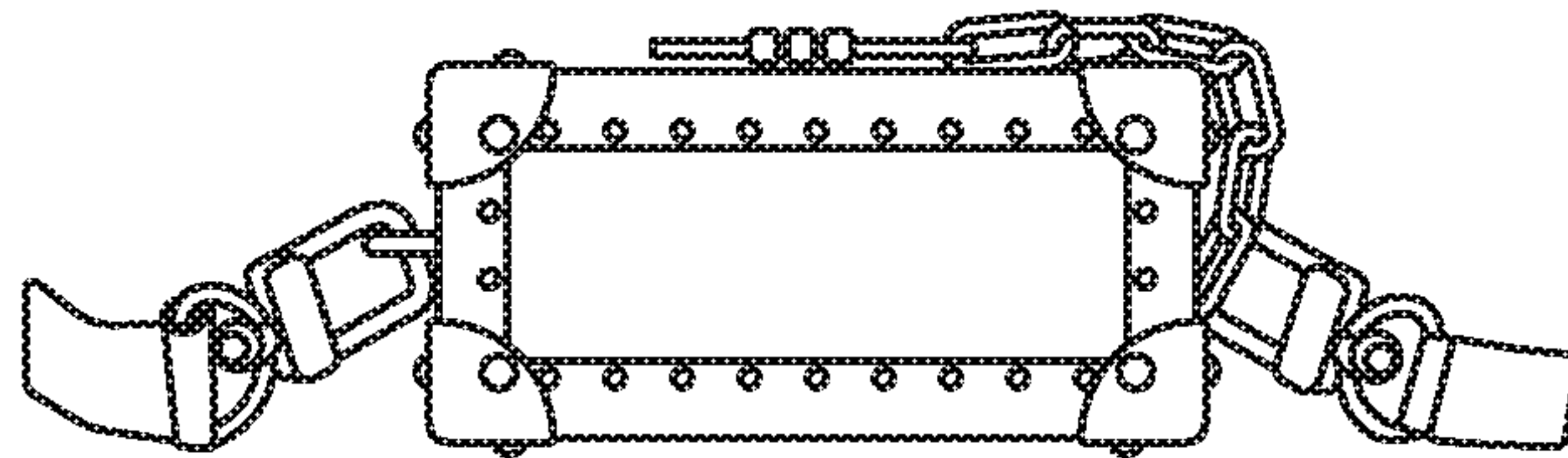

FIG. 7