



US00D928407S

(12) **United States Design Patent** (10) **Patent No.:** **US D928,407 S**
Qi (45) **Date of Patent:** **** Aug. 17, 2021**

(54) **COMBINATION BATH BRUSH AND SPONGE**

(71) Applicant: **Wenting Qi**, Guangdong (CN)

(72) Inventor: **Wenting Qi**, Guangdong (CN)

(**) Term: **15 Years**

(21) Appl. No.: **29/659,297**

(22) Filed: **Aug. 8, 2018**

(51) **LOC (13) Cl.** **28-03**

(52) **U.S. Cl.**
USPC **D28/63**

(58) **Field of Classification Search**
USPC D4/128, 129, 130, 132, 133, 134, 137,
D4/138, 199, 116, 127; D28/7, 63;
D24/211, 214, 215; D32/40, 42, 52;
D30/158
CPC A47K 7/00; A47K 7/02; A47K 7/028
See application file for complete search history.

(56) **References Cited**

U.S. PATENT DOCUMENTS

455,567	A *	7/1891	Kraft	A47L 13/16	15/118
D158,250	S *	4/1950	Cosby, Jr.	D4/127	
6,276,022	B1 *	8/2001	Gallacher	A47K 7/028	15/142
D452,046	S *	12/2001	Borcherds	D28/63	
6,931,689	B2 *	8/2005	Huang	A47K 7/02	15/209.1
7,174,595	B2 *	2/2007	Chen	A47K 7/028	15/110
7,178,192	B2 *	2/2007	Huang	A47K 7/02	15/209.1
D580,659	S *	11/2008	Zemel	D4/132	
7,886,394	B2 *	2/2011	Chen	A47K 7/02	15/104.001
8,141,196	B2 *	3/2012	Chen	A47K 7/02	15/209.1

8,967,898	B1 *	3/2015	Dayeh	A47K 7/028	401/188 R
D832,520	S *	10/2018	Celia, Jr.	D28/63	
D838,496	S *	1/2019	Lin	D4/134	
10,334,994	B1 *	7/2019	Burd	A47K 7/028	
2003/0019063	A1 *	1/2003	Abraham	A46B 15/0089	15/167.1
2014/0299275	A1 *	10/2014	Melet	A47K 5/03	156/580
2015/0000060	A1 *	1/2015	Collins	A47K 7/02	15/104.93
2015/0164680	A1 *	6/2015	Chen	A61F 5/4553	604/330

(Continued)

OTHER PUBLICATIONS

Customer review, "great back brush/loofah!" by Staze Craze on Amazon.com [on-line], [Published May 7, 2019.] [Retrieved from the Internet Sep. 11, 2020], URL: see printed copy for entire web address. (Year: 2019).*

(Continued)

Primary Examiner — Karen E Eldridge Powers

(57) **CLAIM**

The ornamental design for a combination bath brush and sponge, as shown and described.

DESCRIPTION

FIG. 1 is a perspective view of a combination bath brush and sponge showing my new design;
FIG. 2 is a front elevational view thereof;
FIG. 3 is a rear elevational view thereof;
FIG. 4 is a left side elevational view thereof;
FIG. 5 is a right side elevational view thereof;
FIG. 6 is a top plan view thereof; and,
FIG. 7 is a bottom plan view thereof.
The broken lines depict portions of the bath brush and body sponge and form no part of the claimed design.

1 Claim, 7 Drawing Sheets

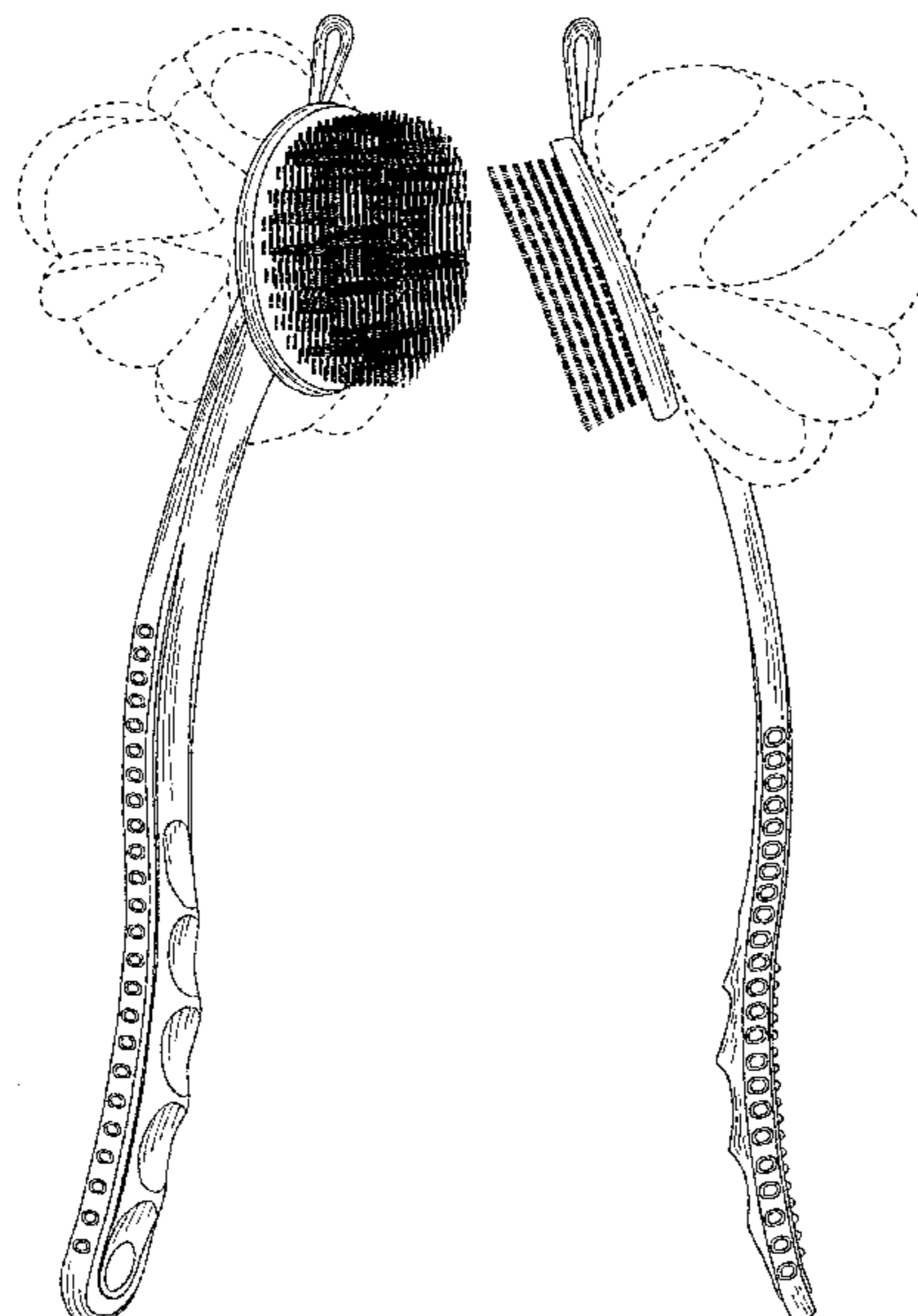

(56)

References Cited

U.S. PATENT DOCUMENTS

2018/0035849 A1* 2/2018 Vergara A47K 7/03

OTHER PUBLICATIONS

Bath Body Brush with Bath Loofahs . . . [on-line], [Original publication date unknown.] [Retrieved from the Internet Sep. 11, 2010.] URL: ><https://www.aliexpress.com/item/32961294211.html>< (Year: 2020).*

Shower Body Brush with Bristles and Loofah . . . by Honoma [on-line], [Original publication date unknown.] [Retrieved from the Internet Sep. 11, 2020.] URL: ><https://www.amazon.com/BGristles-Scrubber-Exfoliating-Massage-Suitable/dp/B07G43Q2KJ>< (Year: 2020).*

Mrosaa 36cm Bath Body Brush Doubled Sided . . . [on-line], [Original publication date unknown.] [Retrieved from the Internet Sep. 11, 2020.] URL: ><https://aliexpress.com/item/32902594499.html>< (Year: 2020).*

* cited by examiner

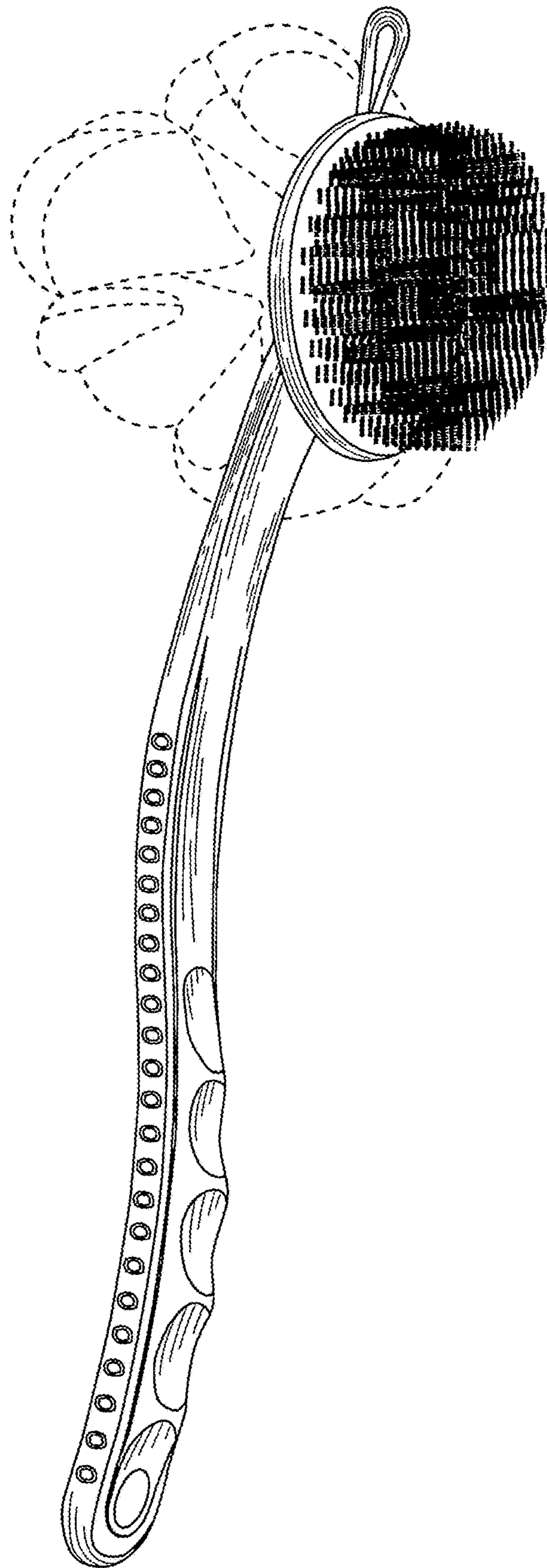

FIG. 1

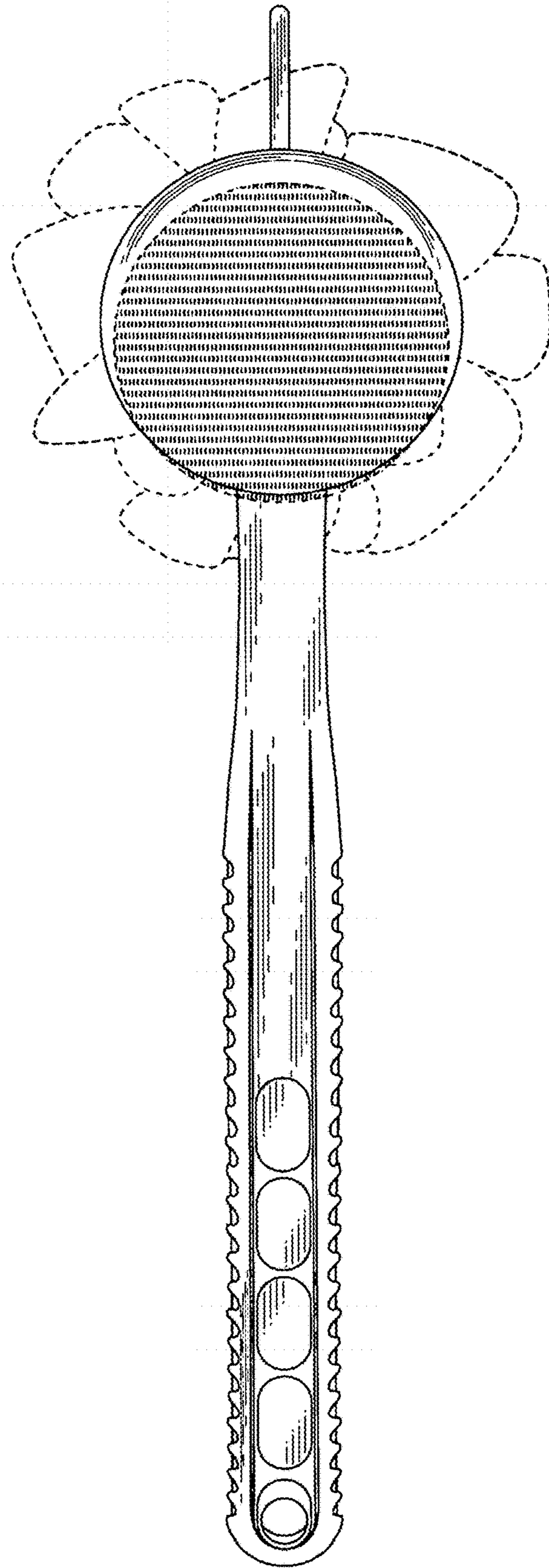

FIG. 2

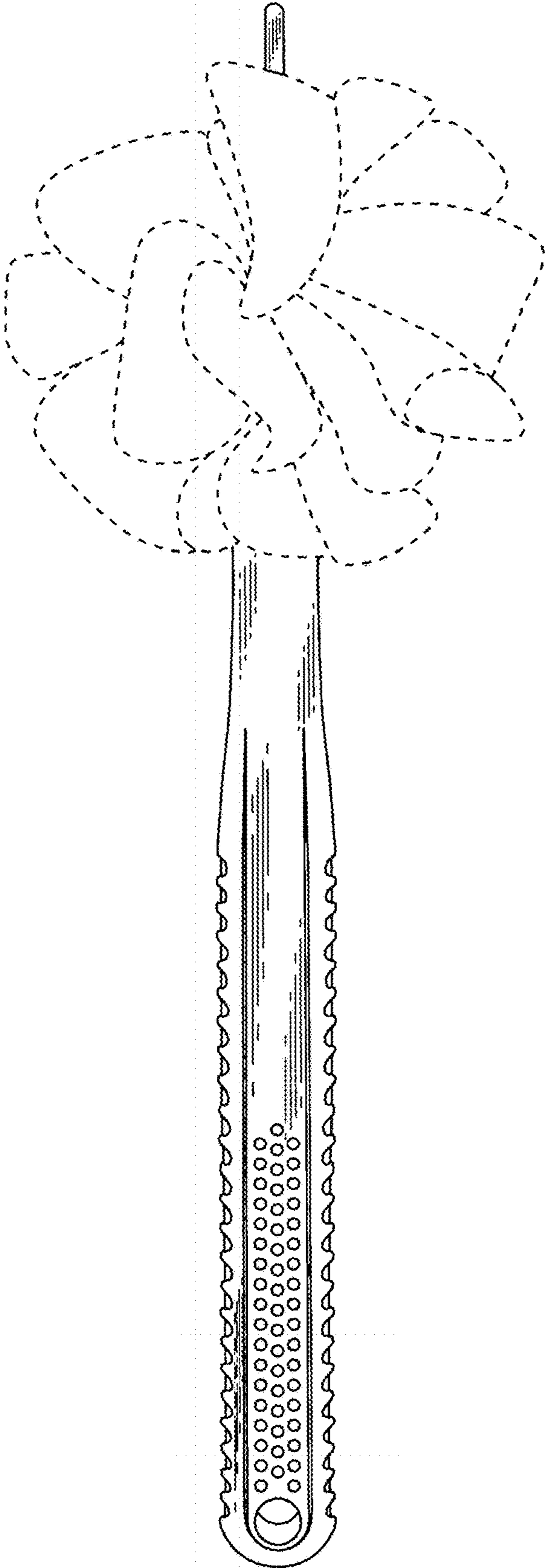

FIG. 3

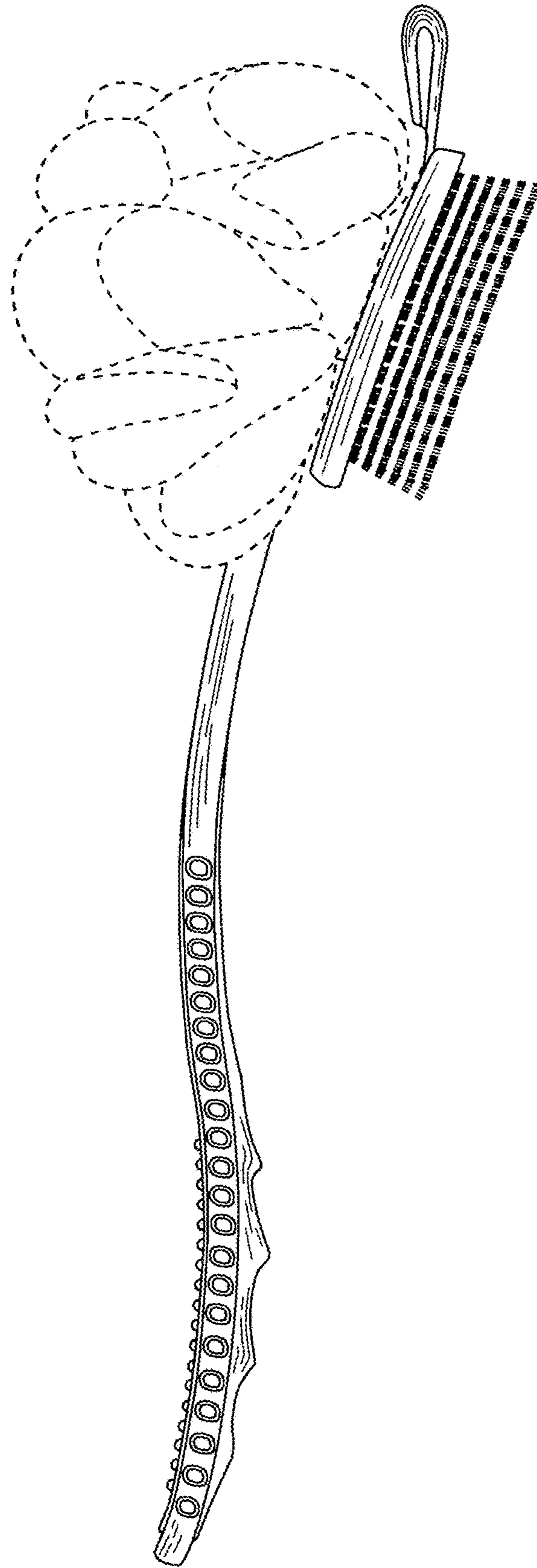

FIG. 4

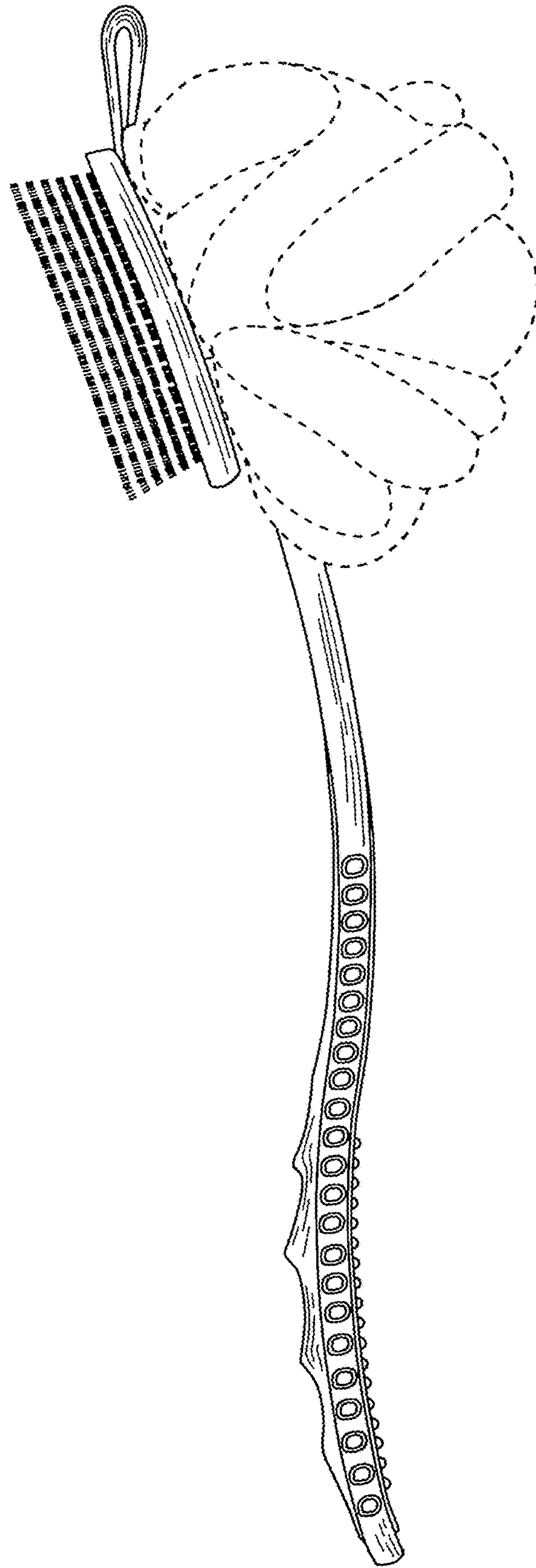

FIG. 5

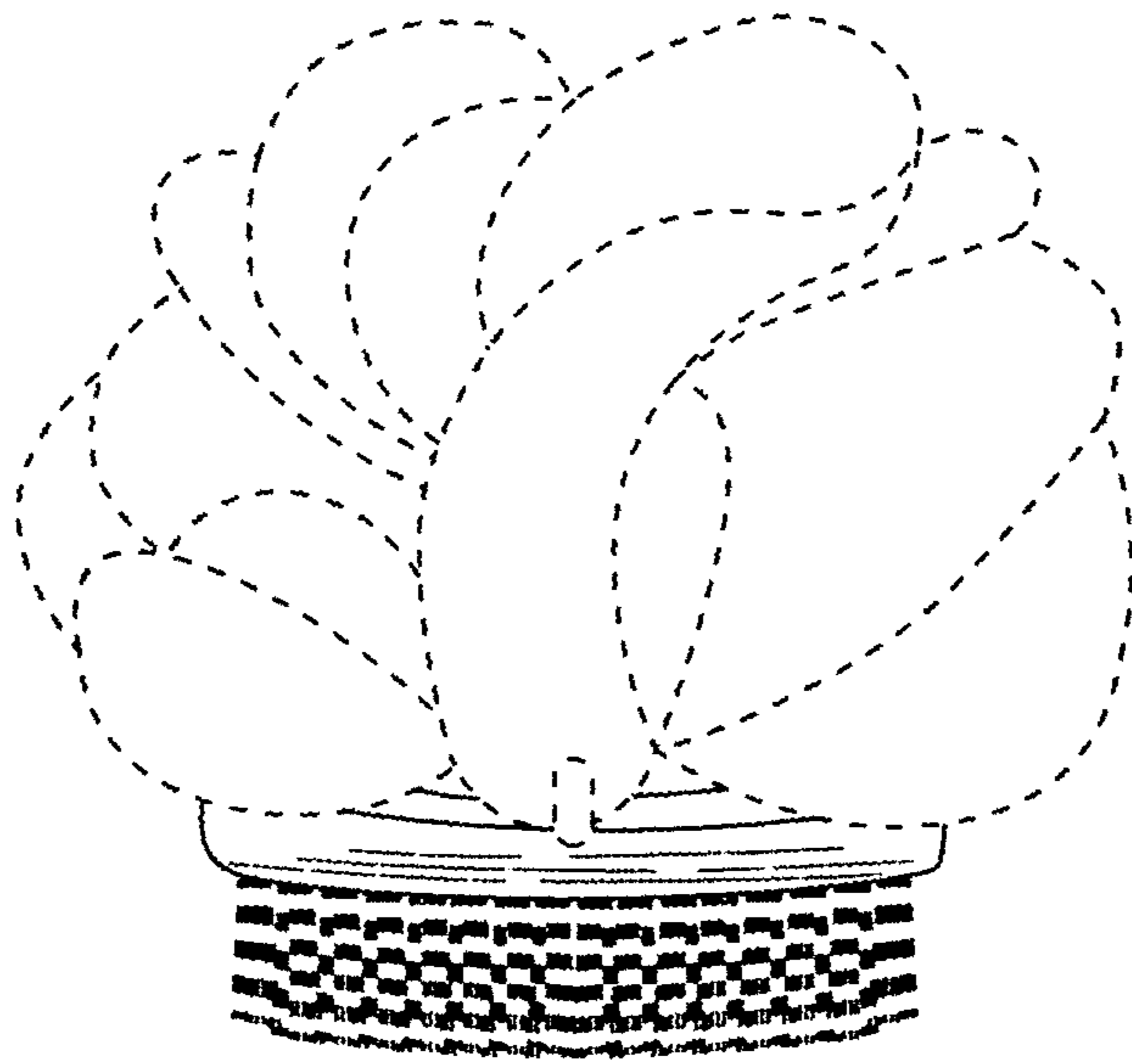

FIG.6

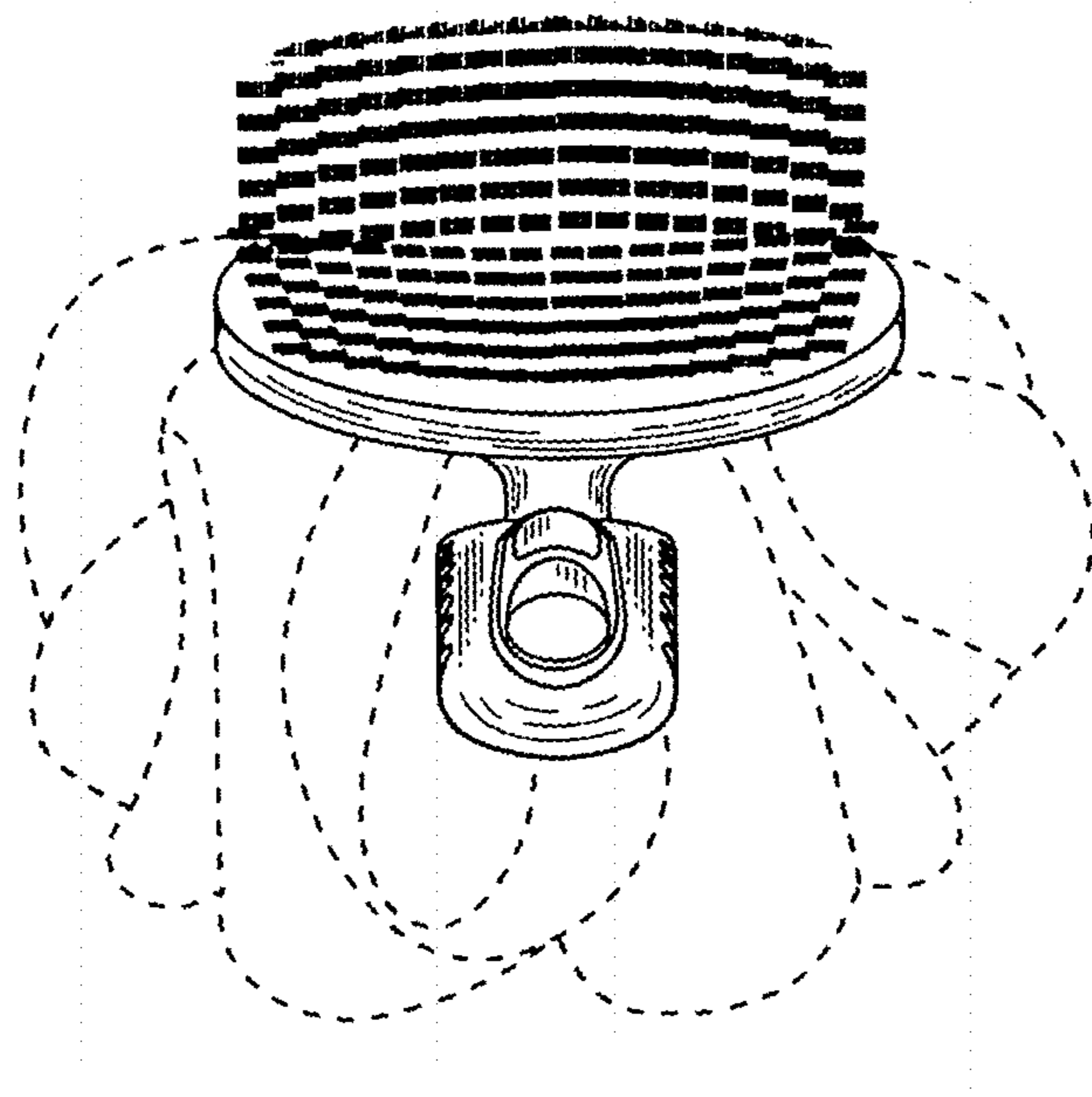

FIG. 7



US00D928407C1

(12) **EX PARTE REEXAMINATION CERTIFICATE** (12137th)
United States Patent
Qi

(10) **Number:** **US D928,407 C1**
(45) **Certificate Issued:** **Sep. 19, 2022**

(54) **COMBINATION BATH BRUSH AND SPONGE**

(71) Applicant: **Wenting Qi**, Guangdong (CN)

(72) Inventor: **Wenting Qi**, Guangdong (CN)

Reexamination Request:

No. 90/020,139, Sep. 27, 2021

Reexamination Certificate for:

Patent No.: **Des. 928,407**
Issued: **Aug. 17, 2021**
Appl. No.: **29/659,297**
Filed: **Aug. 8, 2018**

(51) **LOC (13) Cl.** **03-01**

(52) **U.S. Cl.**
USPC **D3/246**

(58) **Field of Classification Search**

USPC D3/20, 26, 304, 305, 307-311, 315,
D3/318-319, 321, 322

CPC .. A45C 3/00; A45C 3/001; A45C 3/04; A45C
7/00; A45C 7/0018; A45C 7/0059; B62B
5/00; B65D 29/00; B65D 37/00

See application file for complete search history.

(56) **References Cited**

To view the complete listing of prior art documents cited during the proceeding for Reexamination Control Number 90/020,139, please refer to the USPTO's Patent Electronic System.

Primary Examiner — Darlington Ly

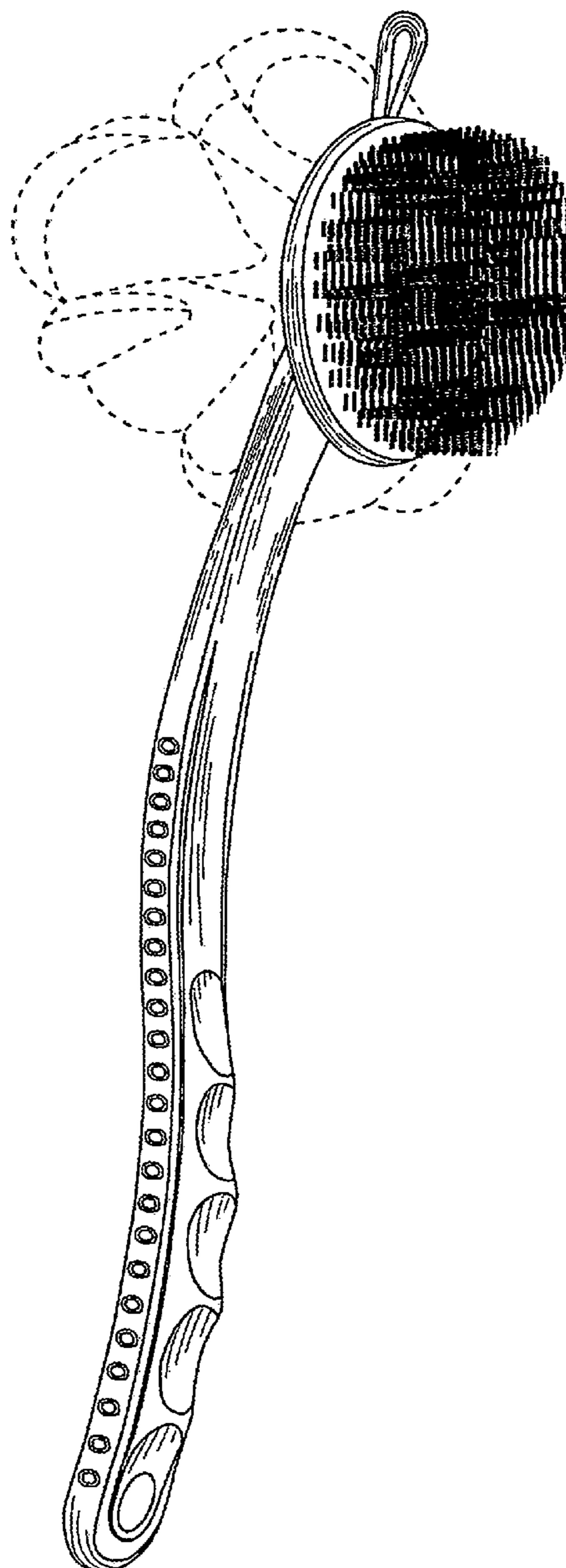

1
EX PARTE
REEXAMINATION CERTIFICATE

THE PATENT IS HEREBY AMENDED AS 5
INDICATED BELOW.

AS A RESULT OF REEXAMINATION, IT HAS BEEN
DETERMINED THAT:

The claim 1 is cancelled. 10

* * * * *