



US00D928388S

(12) **United States Design Patent** (10) **Patent No.:** **US D928,388 S**
Xu (45) **Date of Patent:** **** Aug. 17, 2021**

(54) **LED GROW LIGHT**

(71) Applicant: **Guilan Xu, Jiangxi (CN)**

(72) Inventor: **Guilan Xu, Jiangxi (CN)**

(**) Term: **15 Years**

(21) Appl. No.: **29/700,030**

(22) Filed: **Jul. 30, 2019**

(51) **LOC (13) Cl.** **26-05**

(52) **U.S. Cl.**
USPC **D26/118**

(58) **Field of Classification Search**
USPC D26/24, 34, 51, 55, 59, 72, 76, 78, 79,
D26/80, 81, 85, 86, 88, 90, 118, 120, 138
CPC F21S 8/00; F21S 8/04; F21S 8/08; F21S
8/026; F21S 8/043; F21S 8/066; F21S
8/081; F21S 8/083; F21S 8/085; F21S
8/088; F21V 15/00; F21V 15/01; F21V
21/00; F21V 21/02; F21V 21/005; F21V
21/041; F21V 21/048; F21V 21/049;
F21V 7/00; F21V 7/0008; F21V 9/30
See application file for complete search history.

(56) **References Cited**

U.S. PATENT DOCUMENTS

D740,985 S * 10/2015 Dooley D26/37
D809,702 S * 2/2018 Drew D26/118

D822,881 S * 7/2018 Drew D26/118
D838,032 S * 1/2019 Drew D26/118
D860,502 S * 9/2019 Gregory D26/80
D860,503 S * 9/2019 Gregory D26/80
D884,930 S * 5/2020 Tang D26/24
D890,407 S * 7/2020 Deng D26/118
2019/0387686 A1 * 12/2019 McCormick F21V 23/005
2021/0063007 A1 * 3/2021 Khalifa F21V 29/56

* cited by examiner

Primary Examiner — Wan Laymon
Assistant Examiner — Clint A Samuel

(57) **CLAIM**

The ornamental design for a LED grow light, as shown and described.

DESCRIPTION

FIG. 1 is a front elevational view of a LED grow light showing my new design;
FIG. 2 is a rear elevational view thereof;
FIG. 3 is a right side view thereof;
FIG. 4 is a left side view thereof;
FIG. 5 is a bottom plan view thereof;
FIG. 6 is a top plan view thereof;
FIG. 7 is a perspective view thereof; and,
FIG. 8 is another perspective view thereof.
The broken lines shown in LED grow light form no part of the claimed design.

1 Claim, 5 Drawing Sheets

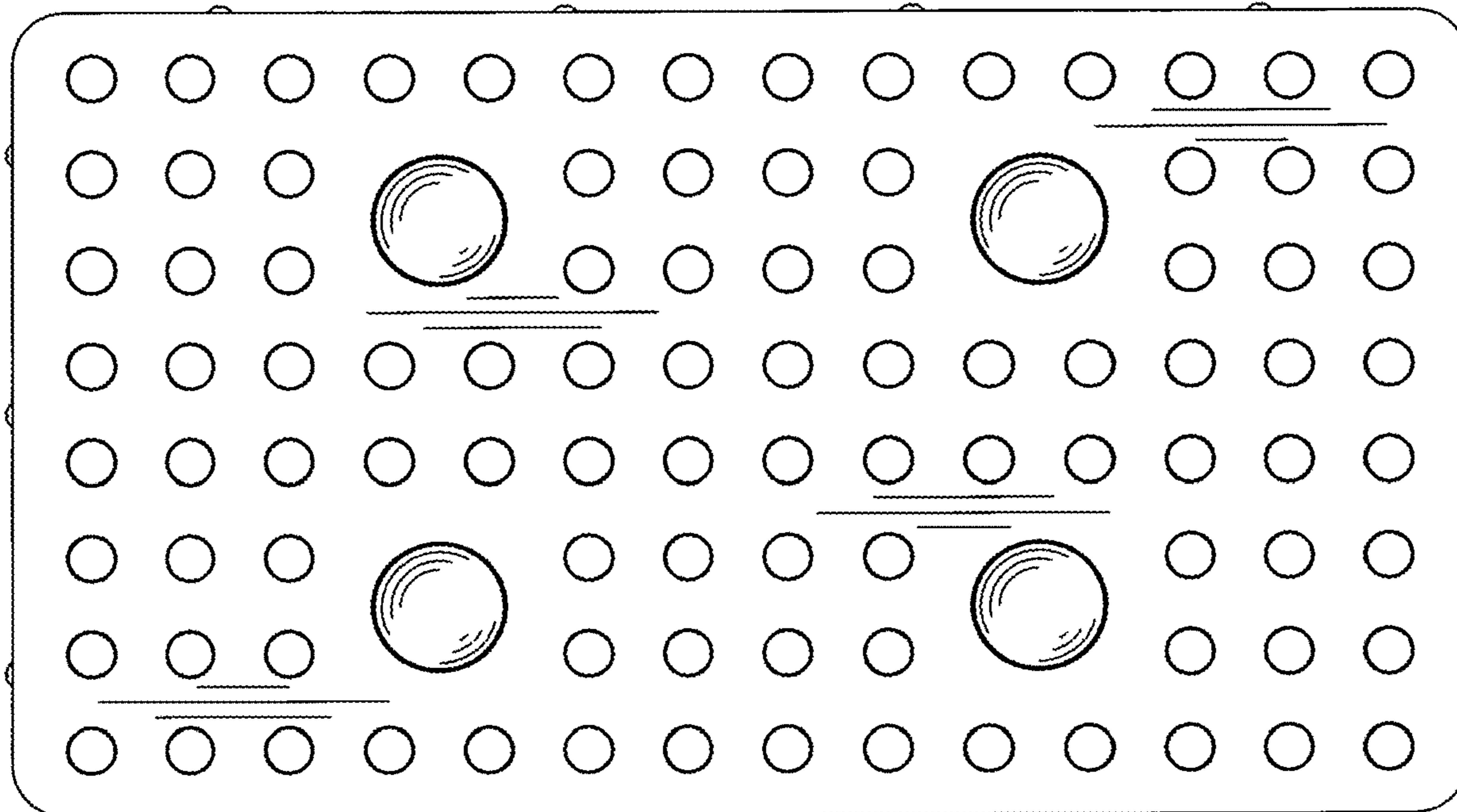

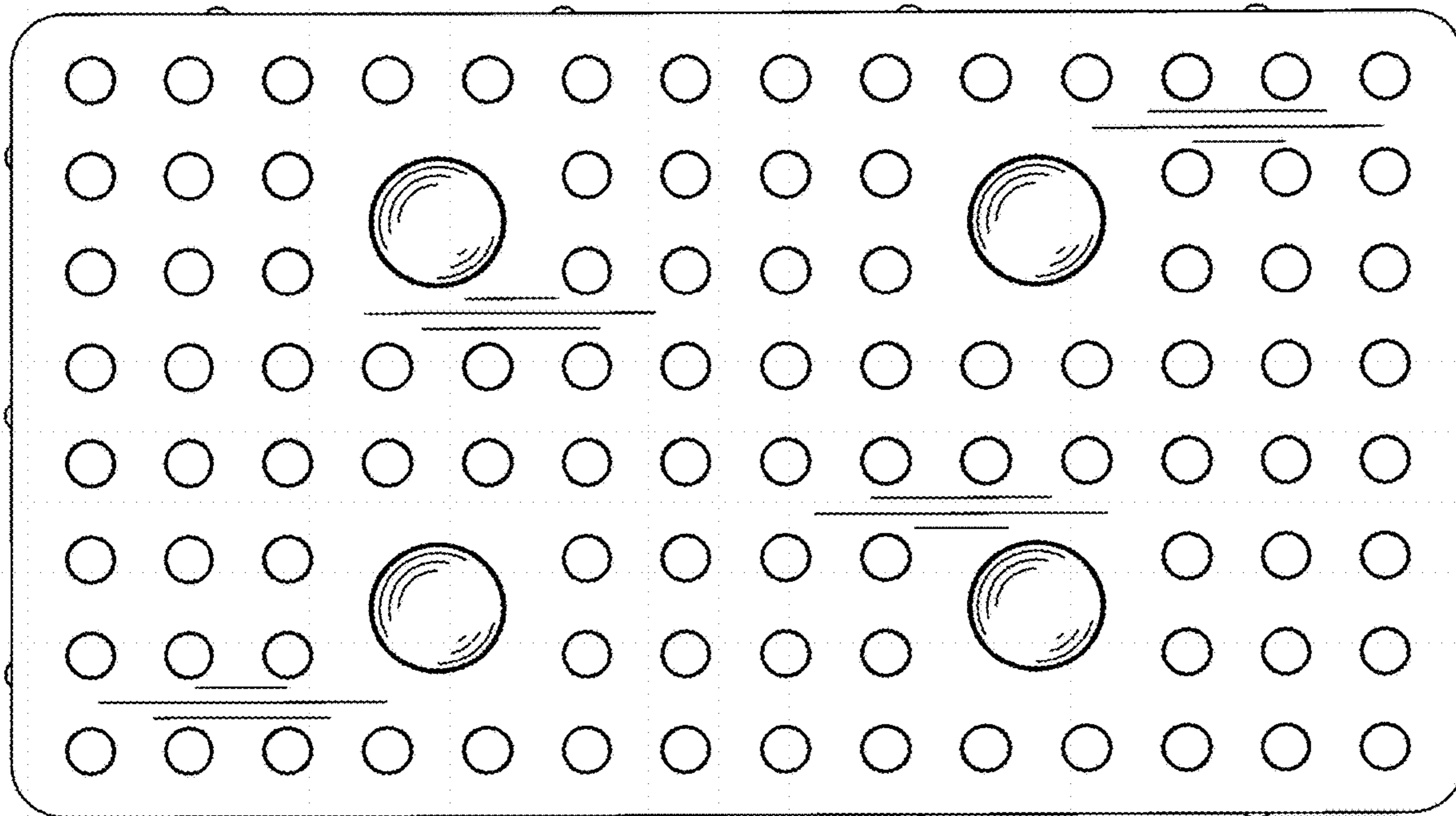

Fig. 1

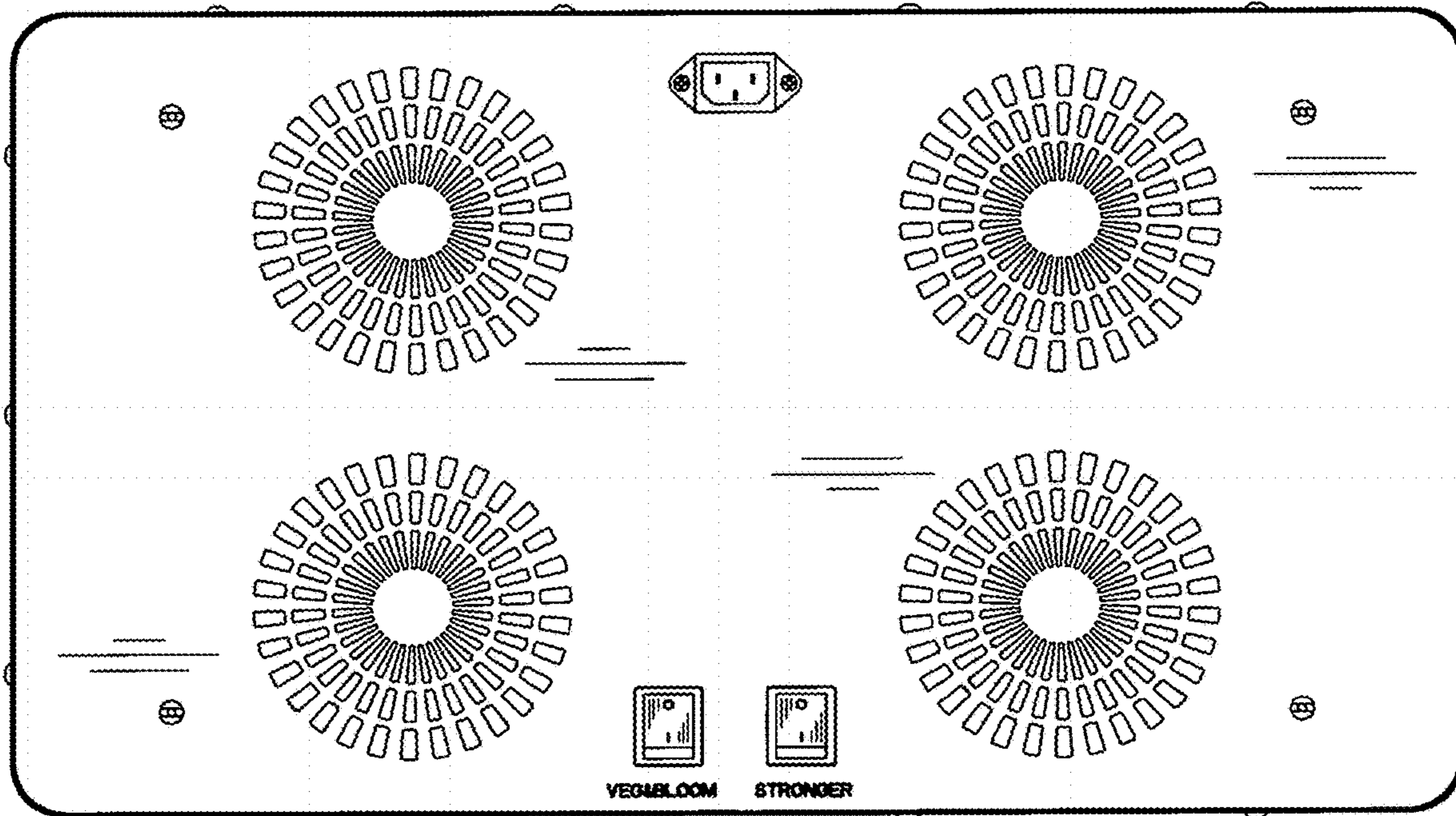

Fig. 2

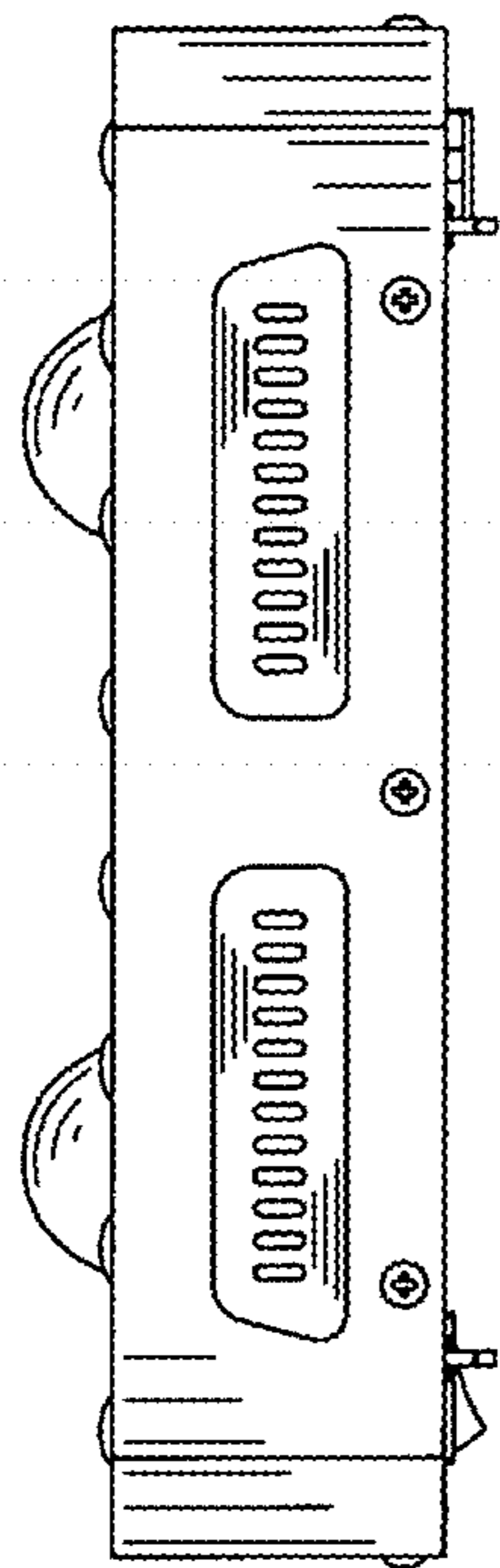

Fig.3

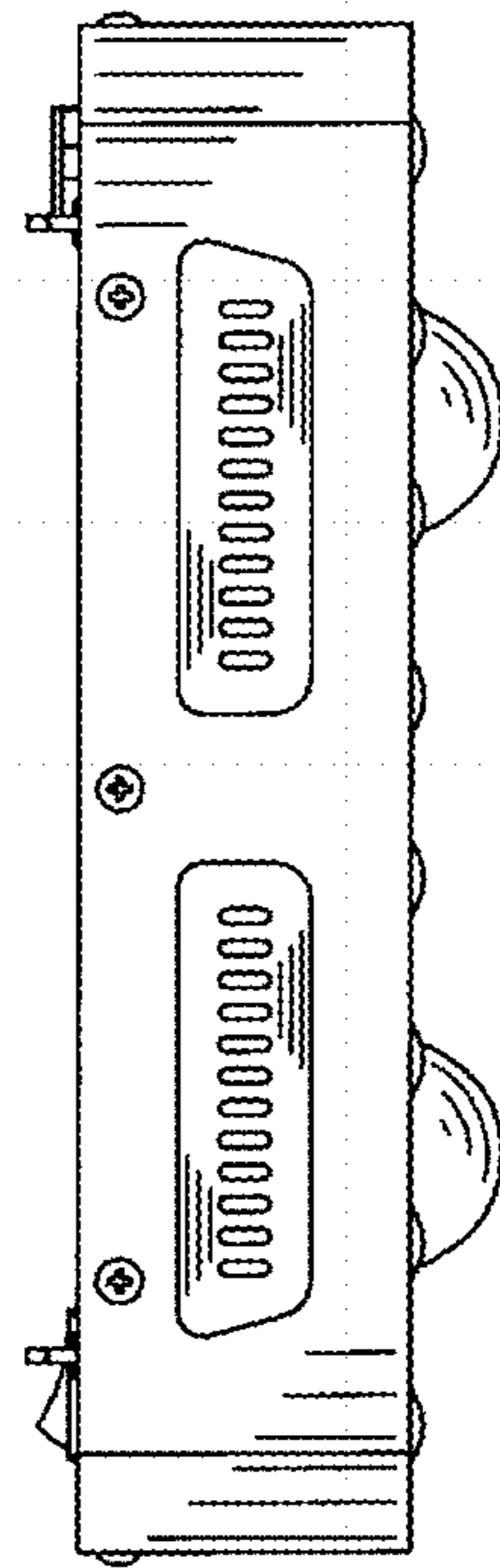

Fig.4

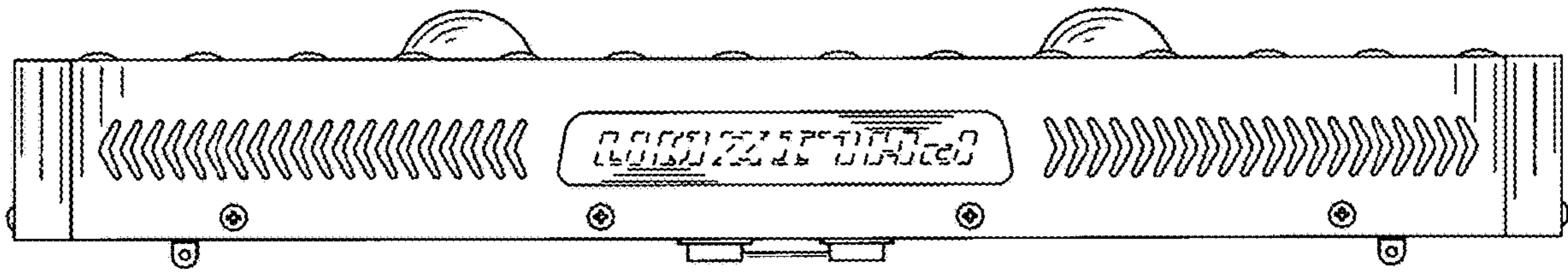

Fig.5

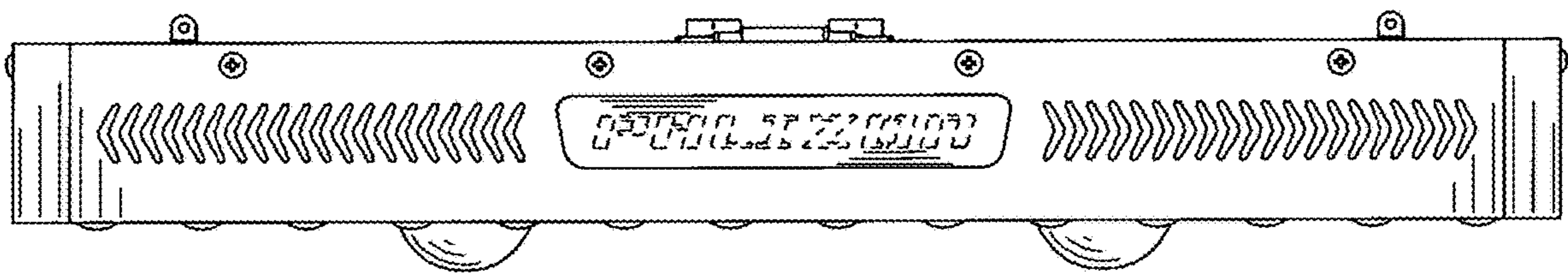

Fig.6

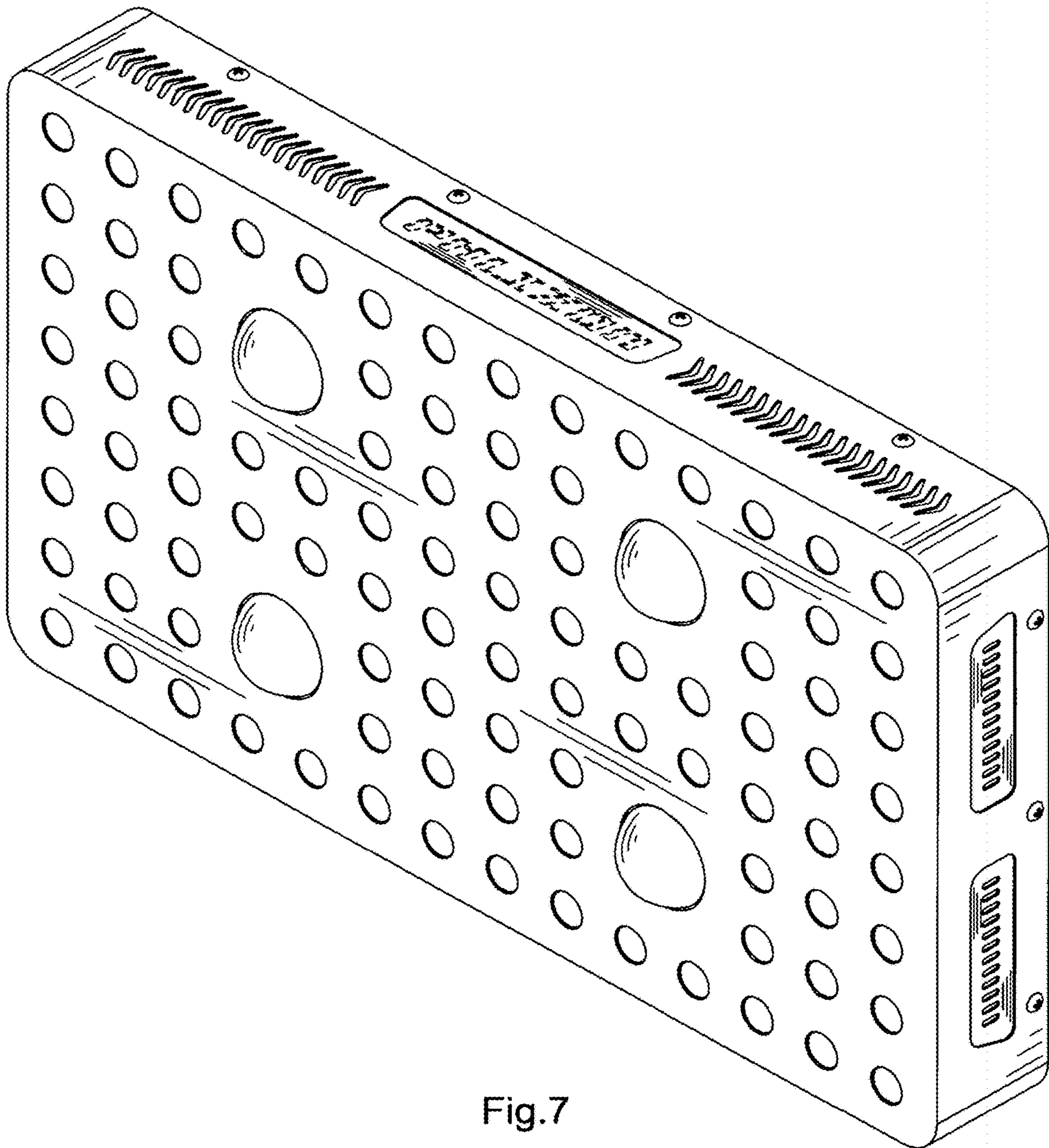

Fig.7

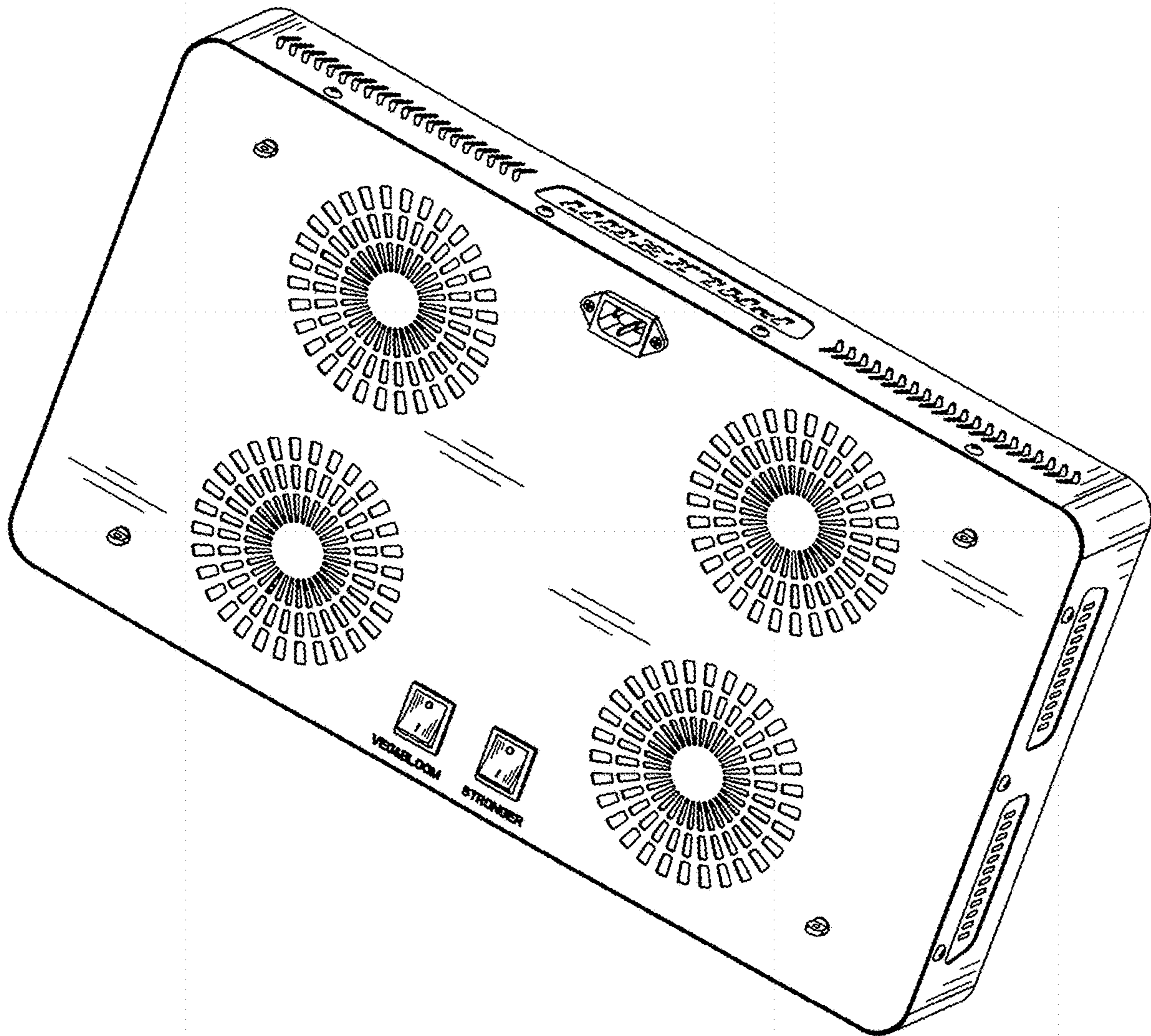

Fig.8