



US00D928380S

(12) **United States Design Patent**
Bai et al.

(10) **Patent No.:** **US D928,380 S**
(45) **Date of Patent:** **** Aug. 17, 2021**

(54) **FLUORESCENT LAMP**

(71) Applicant: **Ningbo Jinghui Opto-Electronic Co., Ltd.**, Zhejiang Province (CN)

(72) Inventors: **Guohui Bai**, Zhejiang Province (CN);
Guohuan Feng, Zhejiang Province (CN)

(73) Assignee: **Ningbo Jinghui Opto-Electronic Co., Ltd.**, Zhejiang Province (CN)

(**) Term: **15 Years**

(21) Appl. No.: **29/710,819**

(22) Filed: **Oct. 25, 2019**

(51) **LOC (13) Cl.** **26-04**

(52) **U.S. Cl.**
USPC **D26/75**

(58) **Field of Classification Search**
USPC D26/3, 24–27, 37–42, 46, 50, 60–69, 72,
D26/74–78, 80–86, 88, 89, 93, 104, 106,
D26/108, 109, 110, 113, 118–120,
D26/122–124, 130, 133–137
CPC ... F21Y 2115/10; F21Y 2103/00; F21S 8/061;
F21S 8/043; F21S 8/06; F21S 8/026;
F21S 8/04; F21S 4/28; F21V 23/008;
F21V 29/76

See application file for complete search history.

(56) **References Cited**

U.S. PATENT DOCUMENTS

D122,903 S * 10/1940 McCarthy D26/78
D122,909 S * 10/1940 Stern F21S 4/26
D26/78

(Continued)

FOREIGN PATENT DOCUMENTS

CA 2074314 A * 1/1994 F21V 19/00
CN 300856663 * 12/2008

(Continued)

OTHER PUBLICATIONS

“Lithonia Lighting L232,” Sep. 28, 2011, amazon.com, site visited Nov. 19, 2020, URL: https://www.amazon.com/Lithonia-Lighting-L232-MV-Fluorescent/dp/B0064FBBP8/ref=sr_1_40?dchild=1&keywords=linear+lamps+with+reflectors&qid=1605812229&sr=8-40 (Year: 2011).*

(Continued)

Primary Examiner — Eric L Goodman

Assistant Examiner — Sarah L Smith

(74) *Attorney, Agent, or Firm* — Greensfelder, Hemker & Gale, P.C.; Richard C. Himelhoch

(57) **CLAIM**

We claim the ornamental design for a fluorescent lamp, as shown and described.

DESCRIPTION

FIG. 1 is a front side plan view of a fluorescent lamp in accordance with the present design;
FIG. 2 is a rear side plan view of the fluorescent lamp of FIG. 1;
FIG. 3 is a left side plan view of the fluorescent lamp of FIG. 1;
FIG. 4 is a right side plan view of the fluorescent lamp of FIG. 1;
FIG. 5 is a top plan view of the fluorescent lamp of FIG. 1;
FIG. 6 is a bottom plan view of the fluorescent lamp of FIG. 1;
FIG. 7 is a front, upper perspective view of the fluorescent lamp of FIG. 1; and,
FIG. 8 is a rear, lower perspective view of the fluorescent lamp of FIG. 1.
The fluorescent lamp is shown with symbolic break lines. The appearance of any portion of the article between the break lines forms no part of the claimed design.

1 Claim, 8 Drawing Sheets

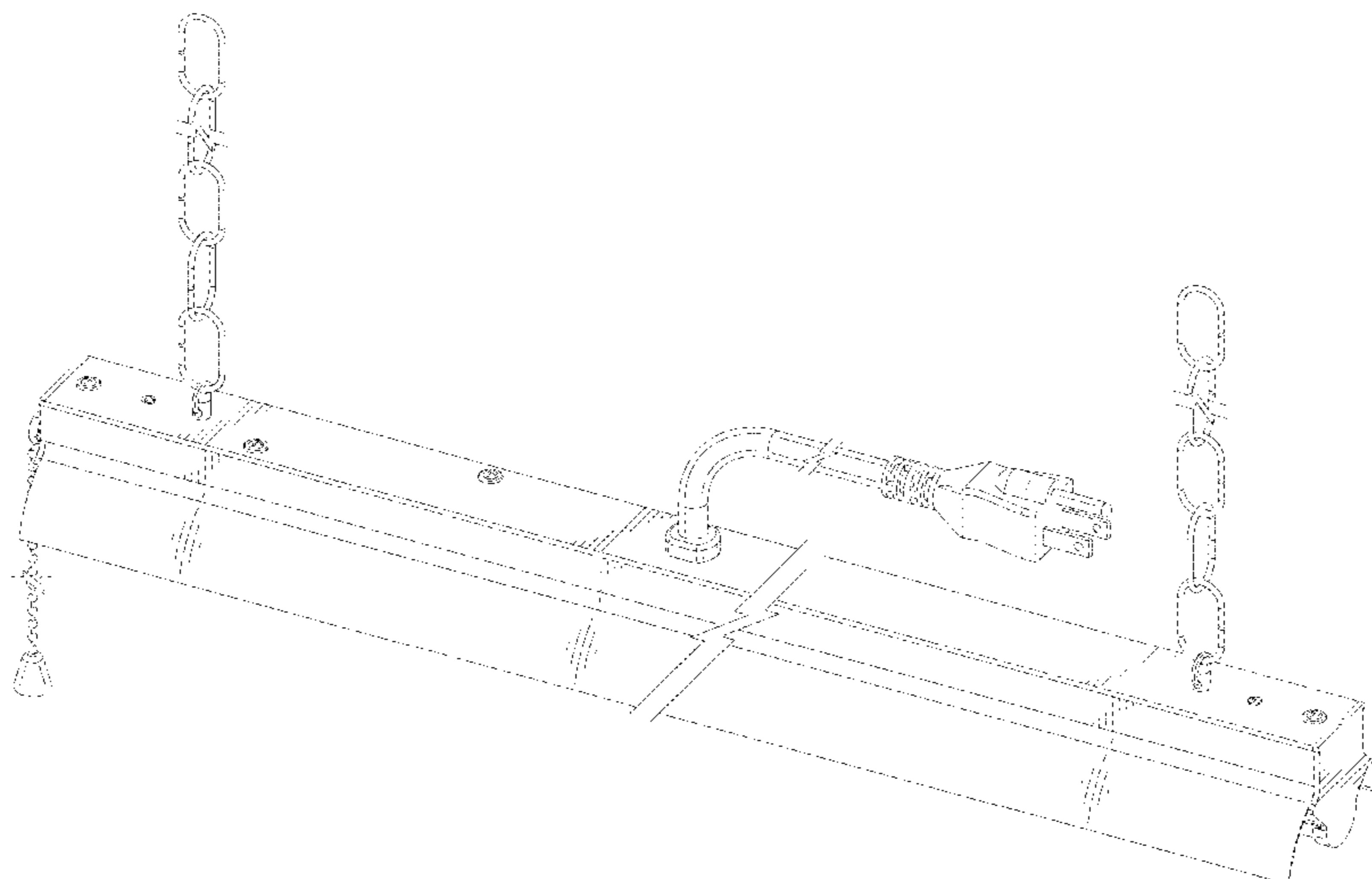

(56)

References Cited

U.S. PATENT DOCUMENTS

D125,001 S * 2/1941 Klingsick F21V 7/24
 D26/78
 D128,968 S * 8/1941 Scribner D26/78
 5,371,661 A * 12/1994 Simpson F21V 19/008
 362/219
 D497,026 S * 10/2004 Hand D26/78
 7,011,428 B1 * 3/2006 Hand F21V 7/24
 362/217.05
 D696,810 S * 12/2013 Ni D26/76
 10,415,800 B2 * 9/2019 Yifan F21V 29/507
 D883,548 S * 5/2020 Hand D26/63
 D885,634 S * 5/2020 Bhavanbhai Patel
 F21V 29/507
 D26/76
 2020/0340633 A1 * 10/2020 Chen F21S 4/26

FOREIGN PATENT DOCUMENTS

CN 303135382 * 3/2015
 CN 303425249 * 10/2015
 CN 303534585 * 12/2015

CN 208457679 U * 2/2019
 CN 208457775 U * 2/2019
 CN 305246620 * 7/2019
 EM 002593384-0002 * 1/2015

OTHER PUBLICATIONS

“NJZ Lighting Launches UL844-Class I,” Mar. 31, 2017, ledsmagazine.com, site visited Nov. 20, 2020, URL: <https://www.ledsmagazine.com/directory/press-release/14057151/njz-lighting-technology-co-ltd-njz-lighting-launches-ul844class-i-div-2-ranger-series-hazloc-led-luminaires> (Year: 2017).*

“Brillihood 2-Pack 8FT LED Shop Light,” Jun. 5, 2018, amazon.com, site visited Nov. 19, 2020, URL: https://www.amazon.com/Equivalent-Fluorescent-Replacement-Warehouse-Supermarket/dp/B074Z7HNZQ/ref=sr_1_149?dchild=1&keywords=linear+lamps+with+reflectors&qid=1605811546&sr=8-149 (Year: 2018).*

“Leonlite 4FT LED Shop Light Linkable,” May 5, 2019, amazon.com, site visited Nov. 19, 2020, URL: https://www.amazon.com/LEONLITE-Utility-Integrated-Linkable-Ceiling/dp/B07RFGFV4C/ref=sr_1_125?dchild=1&keywords=linkable+led+light&qid=1605807973&s=hi&sr=1-125 (Year: 2019).*

* cited by examiner

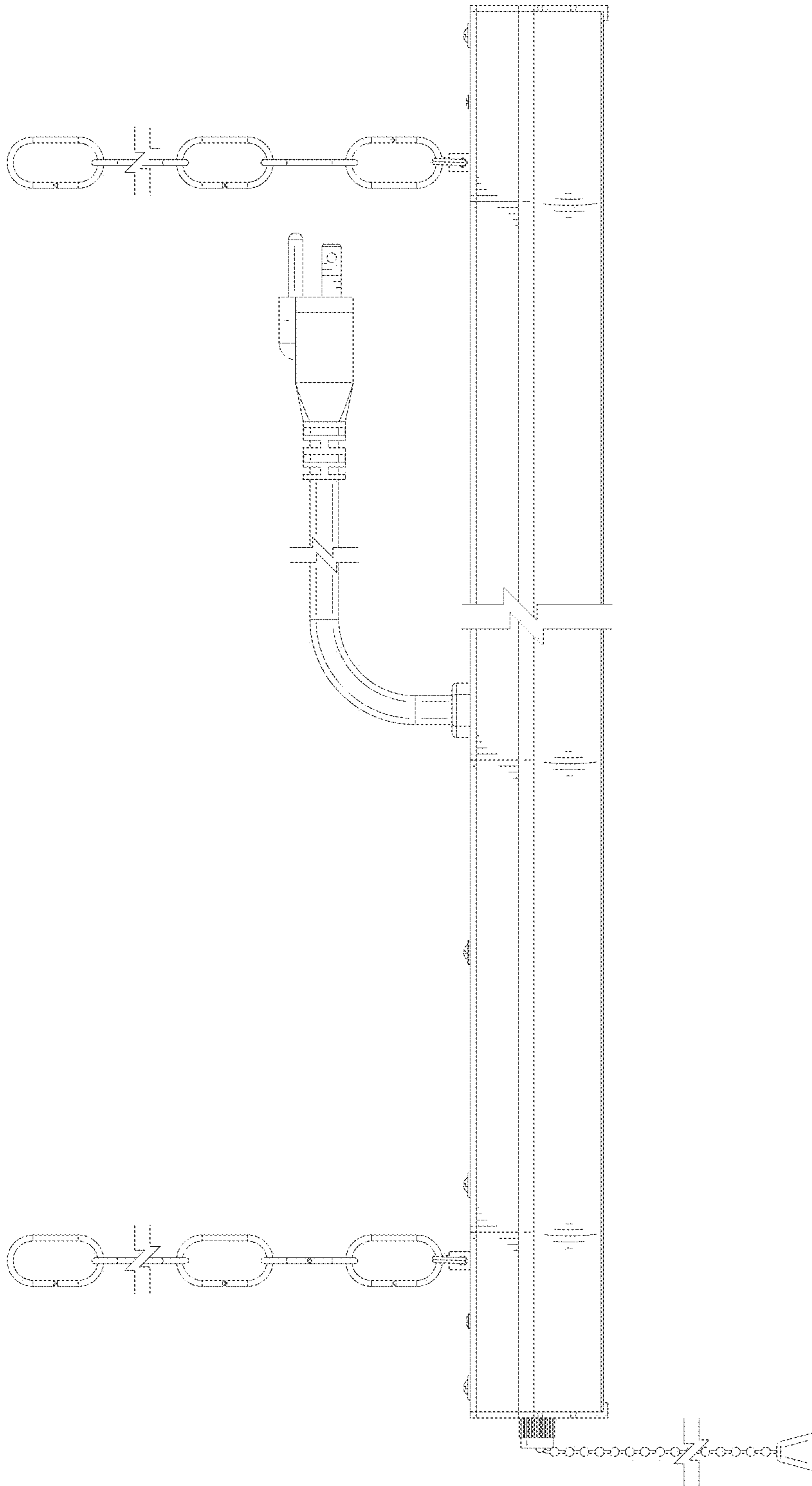

FIG.1

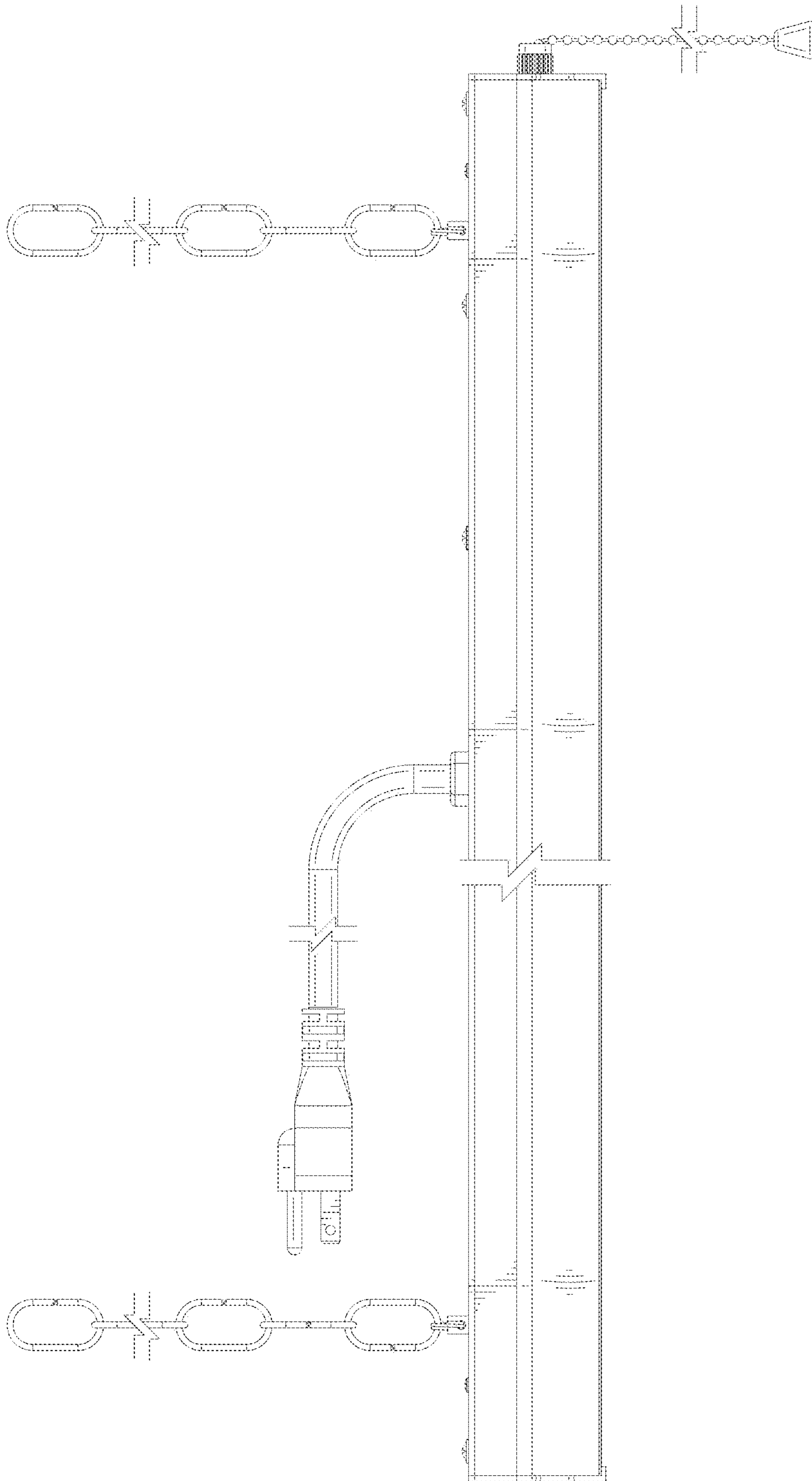

FIG.2

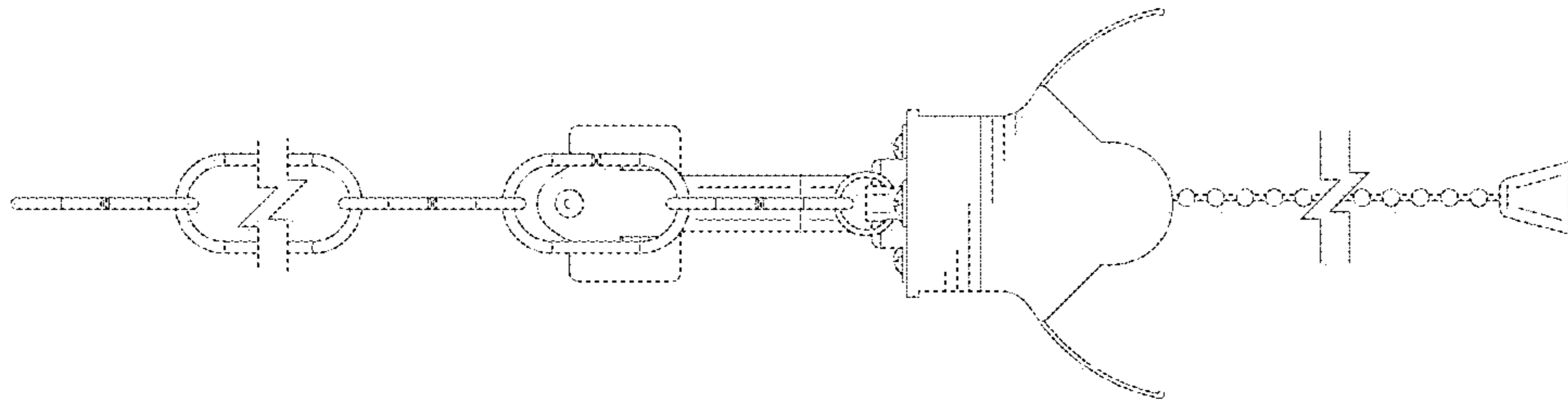

FIG.4

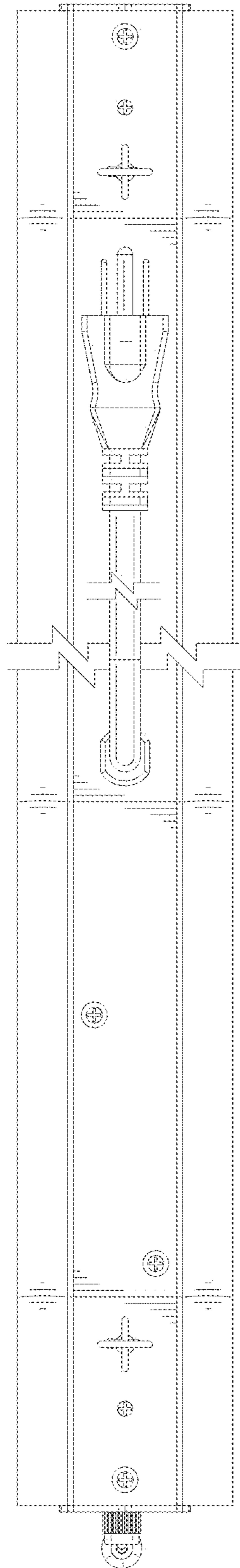

FIG.5

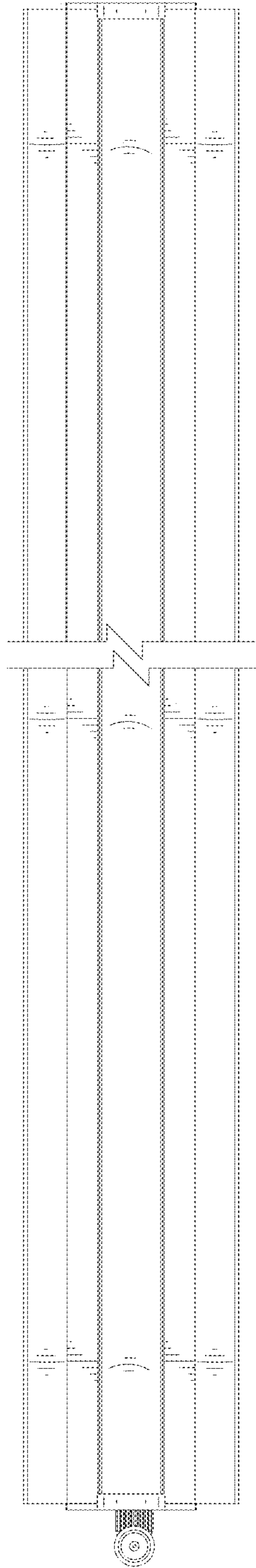

FIG.6

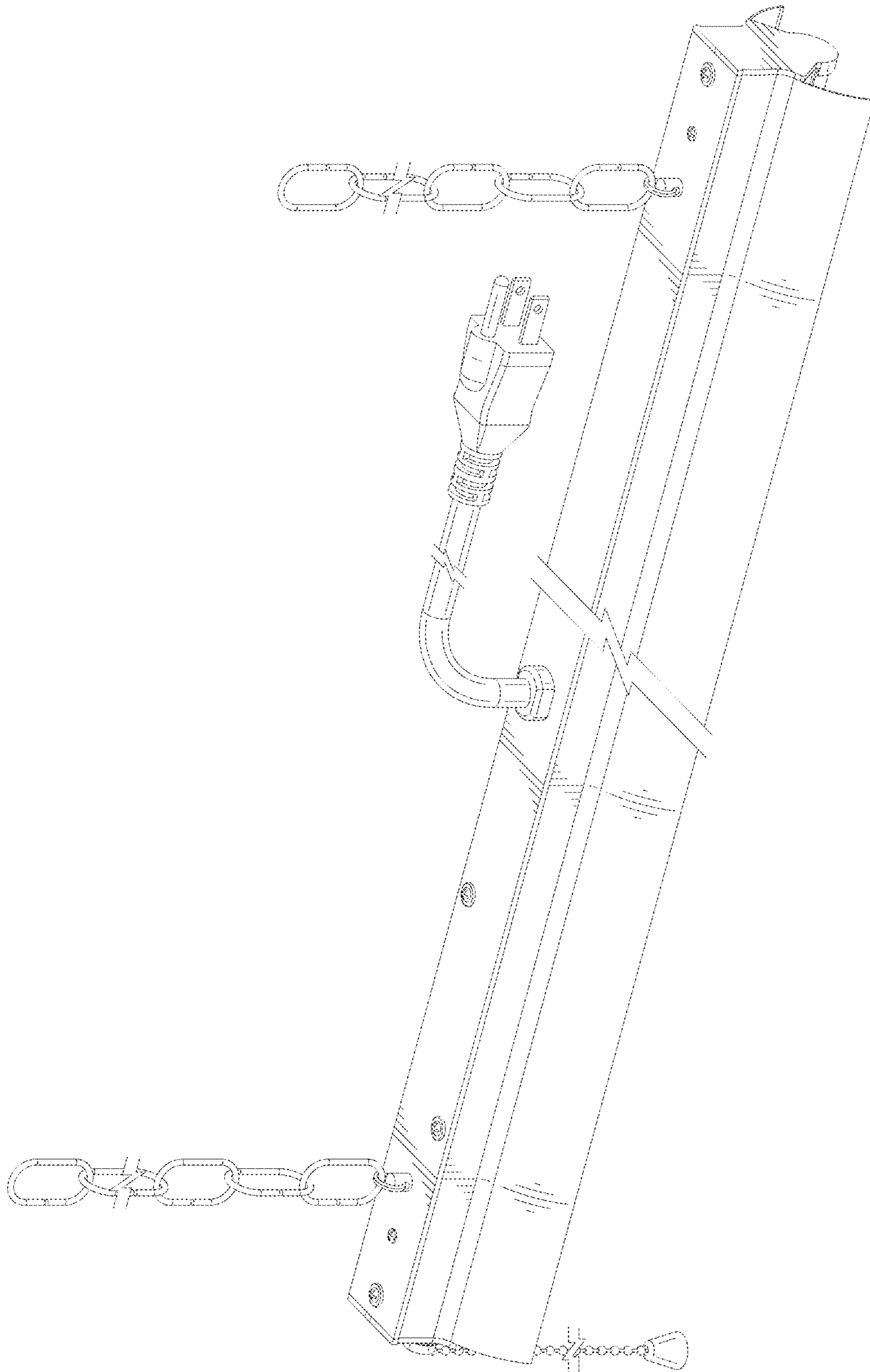

FIG.7

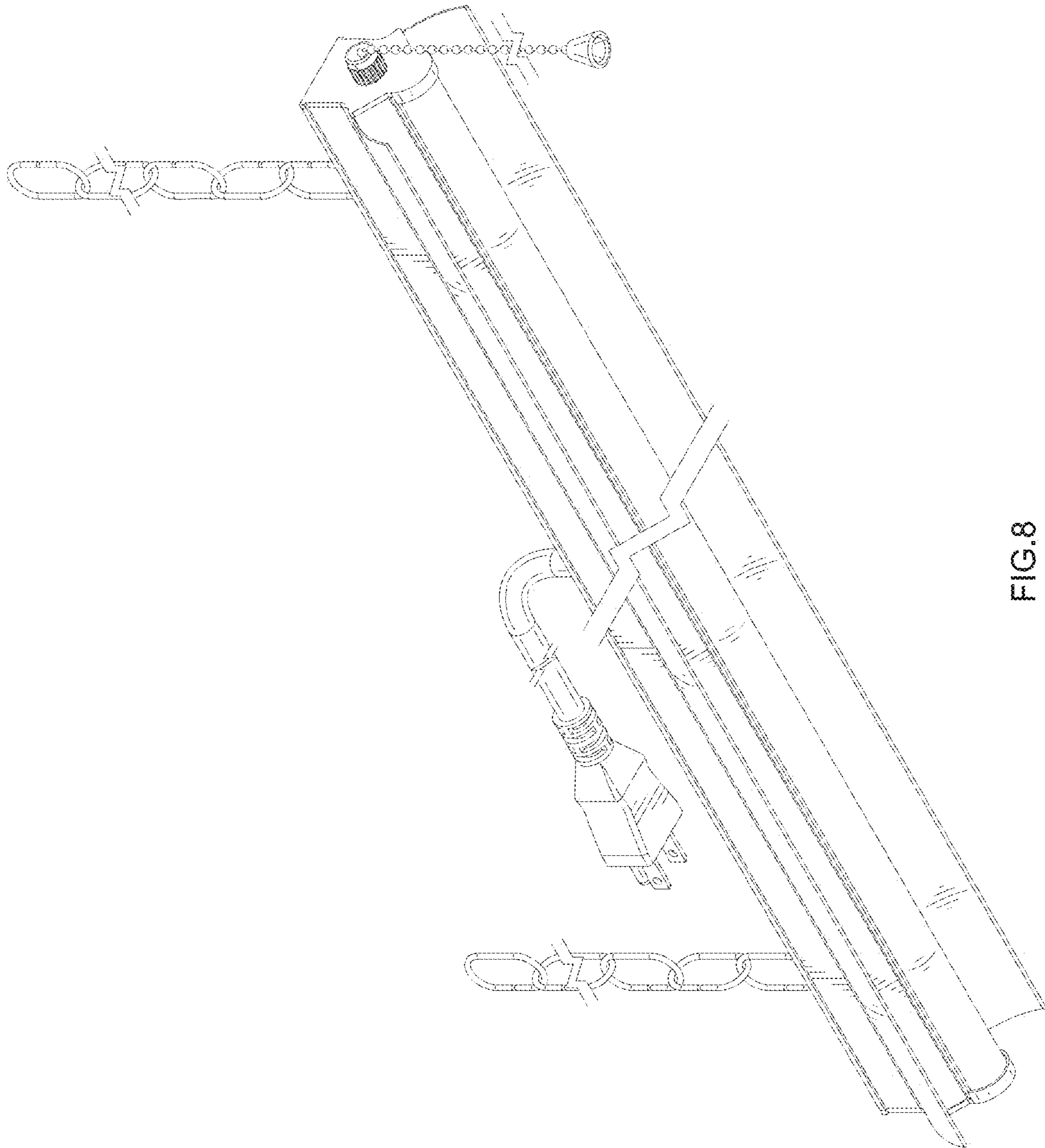

FIG.8