



US00D928340S

(12) **United States Design Patent** (10) **Patent No.:** **US D928,340 S**  
**Chen** (45) **Date of Patent:** **\*\* Aug. 17, 2021**

(54) **UV LIGHT SANITIZER**

OTHER PUBLICATIONS

(71) Applicant: **Shenzhen Zaiwan Technology Co., Ltd.**, Shenzhen (CN)

Amazon.com: Rveal | UVILIZER Extra—UV Light Sanitizer & Portable Ultraviolet Sterilizer Wand (Rechargeable UV-C LED Disinfection Lamp | UVC Cleaner for Home, Car, Travel | Kills Germs, Bacteria, Viruses | USA). Retrieved from Amazon website at: <https://www.amazon.com/Rveal-UVILIZER-Extra-Disinfection->

(72) Inventor: **Lifang Chen**, Shenzhen (CN)

Rechargeable/dp/B086QCL79F/ref=sr\_1\_11?dchild=1&keywords=portable+uv-c+light+sterilizer&qid=1619699454&sr=8-11—Product first available on Apr. 2, 2020.\*

(\*\*) Term: **15 Years**

(21) Appl. No.: **29/731,676**

(22) Filed: **Apr. 17, 2020**

\* cited by examiner

(30) **Foreign Application Priority Data**

Feb. 17, 2020 (CN) ..... 202030052934.6

*Primary Examiner* — Anhdao Doan

(51) **LOC (13) Cl.** ..... **24-01**

(74) *Attorney, Agent, or Firm* — Novoclaims Patent Services LLC; Mei Lin Wong

(52) **U.S. Cl.**  
USPC ..... **D24/217**

(58) **Field of Classification Search**  
USPC ..... D24/107, 216, 217, 218, 231, 232, 234, D24/133; D26/37; D32/1  
CPC ... A61L 2/025; A61L 2/07; A61L 2/10; A61L 2/18; A61L 2/24; A61L 2/26; A61L 2202/10; A61L 2202/11; A61L 2202/14; A61L 2202/23; A61L 2202/24; A61L 2202/122; A61L 2202/182  
See application file for complete search history.

(57) **CLAIM**

The ornamental design for a UV light sanitizer, as shown and described.

**DESCRIPTION**

FIG. 1 is a perspective view of a UV light sanitizer showing my new design;

(56) **References Cited**

**U.S. PATENT DOCUMENTS**

D485,364 S \* 1/2004 Lee ..... D24/217  
7,888,657 B1 \* 2/2011 Zadro ..... A61L 2/10  
250/455.11  
D652,529 S \* 1/2012 Eum ..... D24/217  
D691,310 S \* 10/2013 Zhou ..... D26/37  
D870,313 S \* 12/2019 Ou Yang ..... D24/217  
D876,663 S \* 2/2020 Yellen ..... D24/217  
D898,219 S \* 10/2020 Xie ..... D24/217

FIG. 2 is a bottom perspective view thereof;

FIG. 3 is a front view thereof;

FIG. 4 is a rear view thereof;

FIG. 5 is a left side view thereof;

FIG. 6 is a right side view thereof;

FIG. 7 is a top view thereof; and,

FIG. 8 is a bottom view thereof.

The broken lines in the drawings depict portions of the UV light sanitizer that form no part of the claimed design.

**1 Claim, 8 Drawing Sheets**

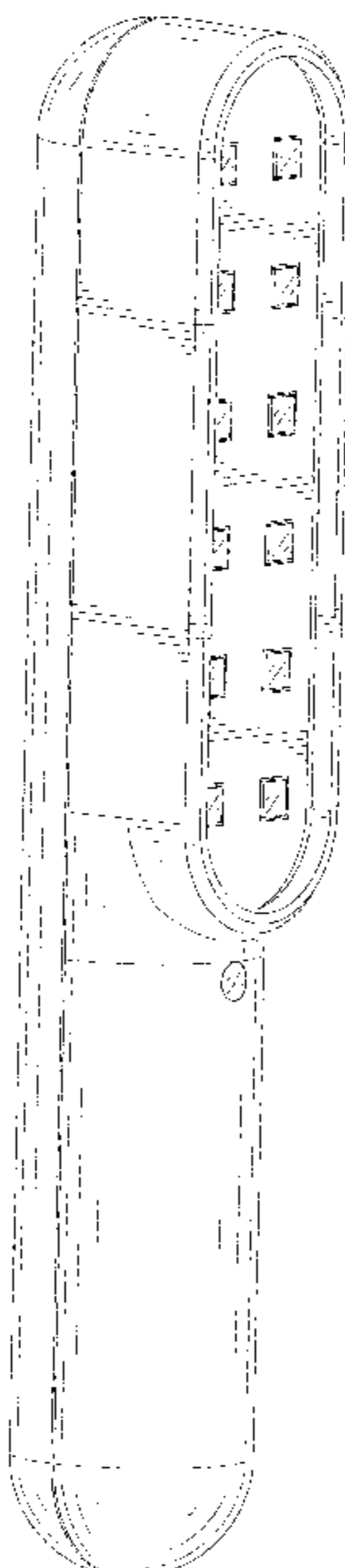

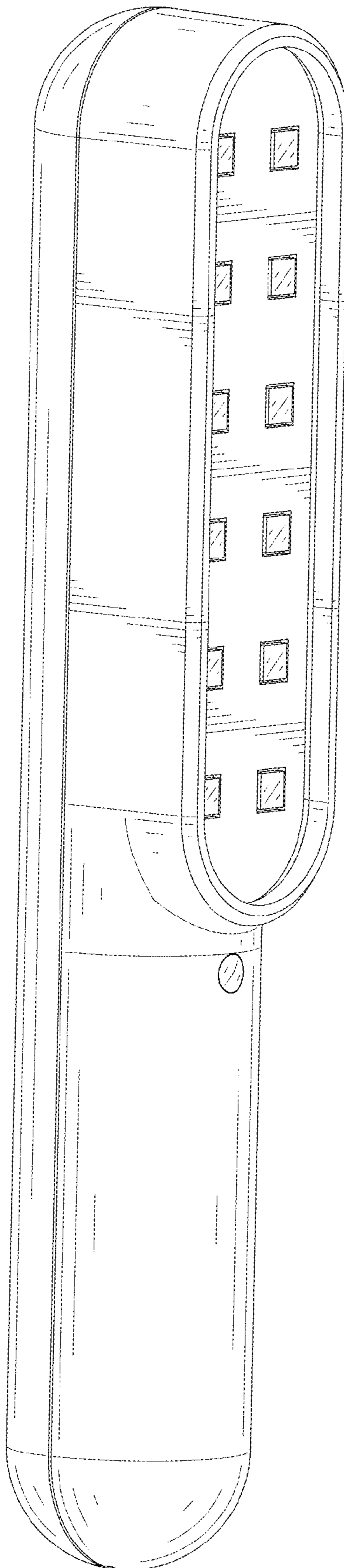

FIG.1

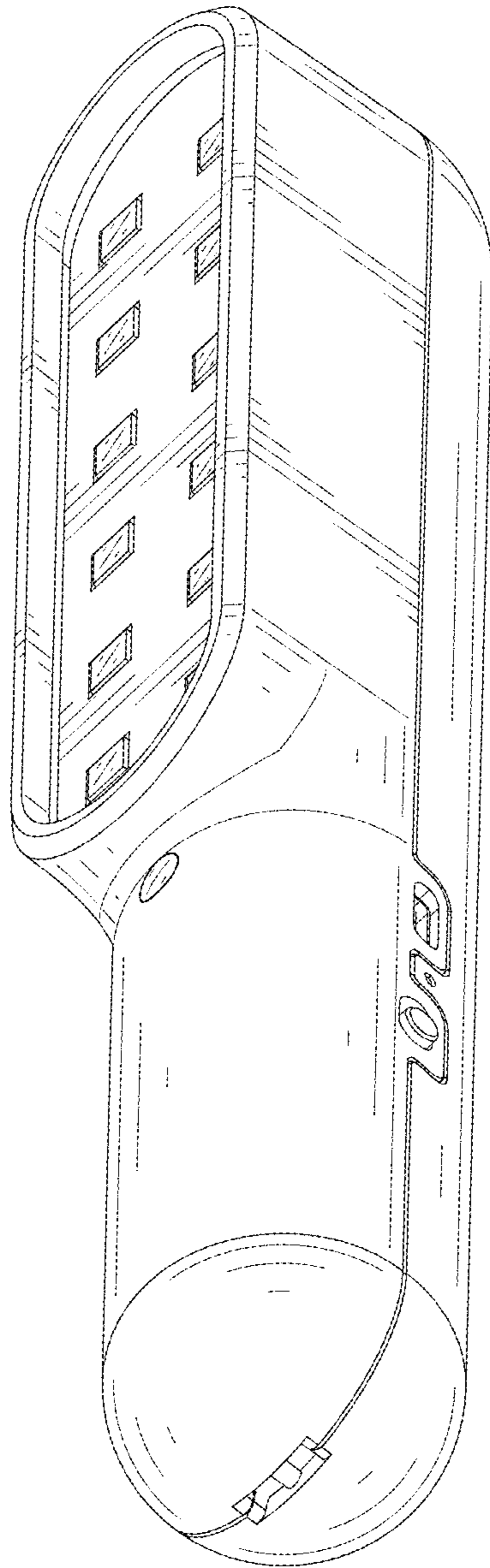

FIG.2

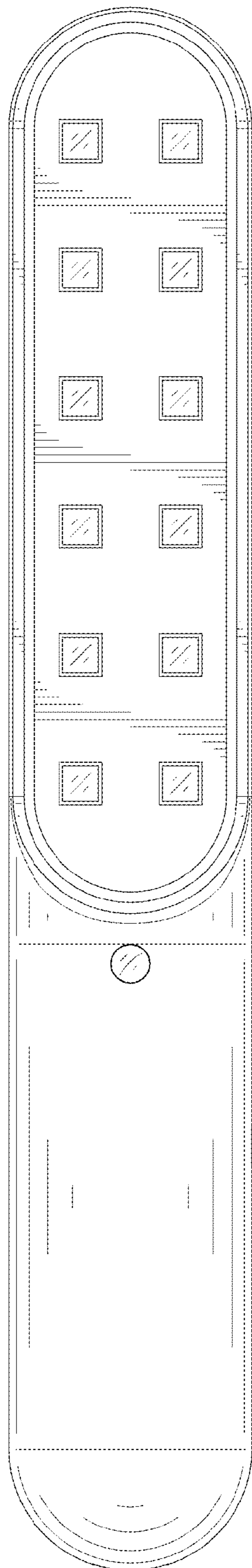

FIG.3

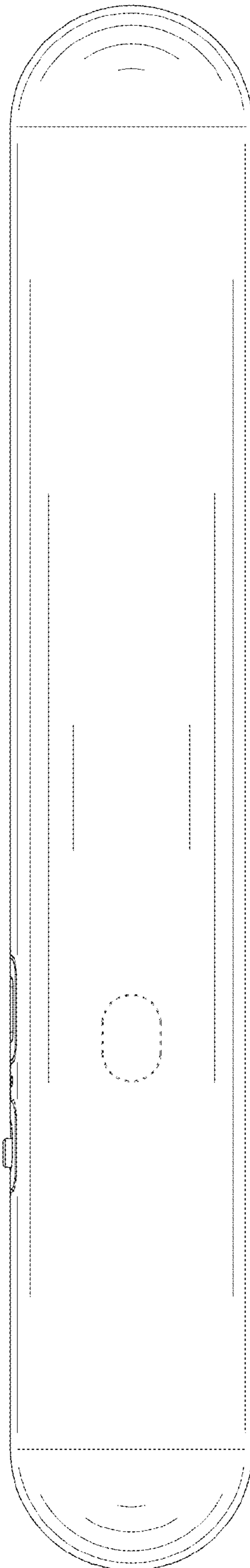

FIG.4

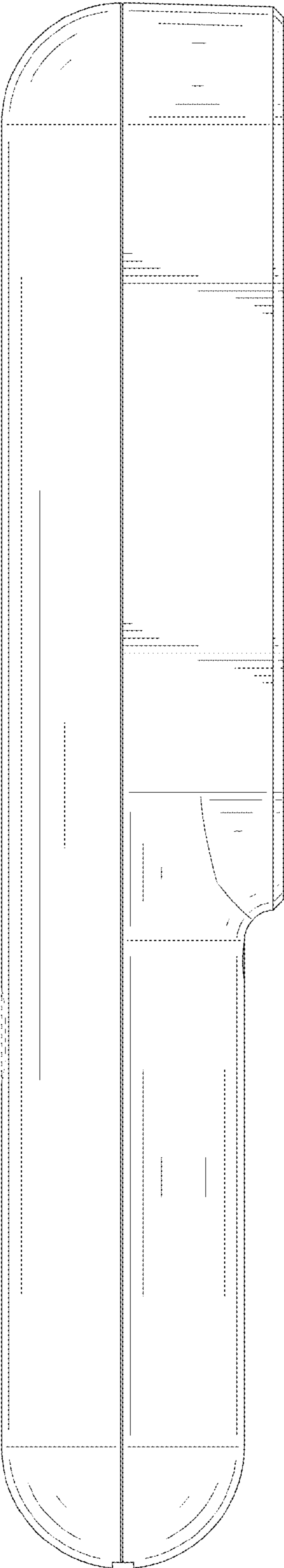

FIG.5

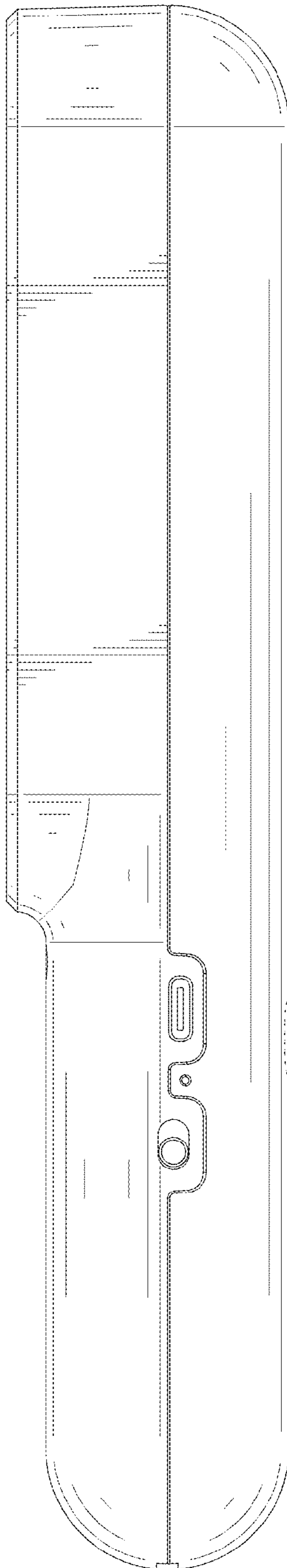

FIG.6

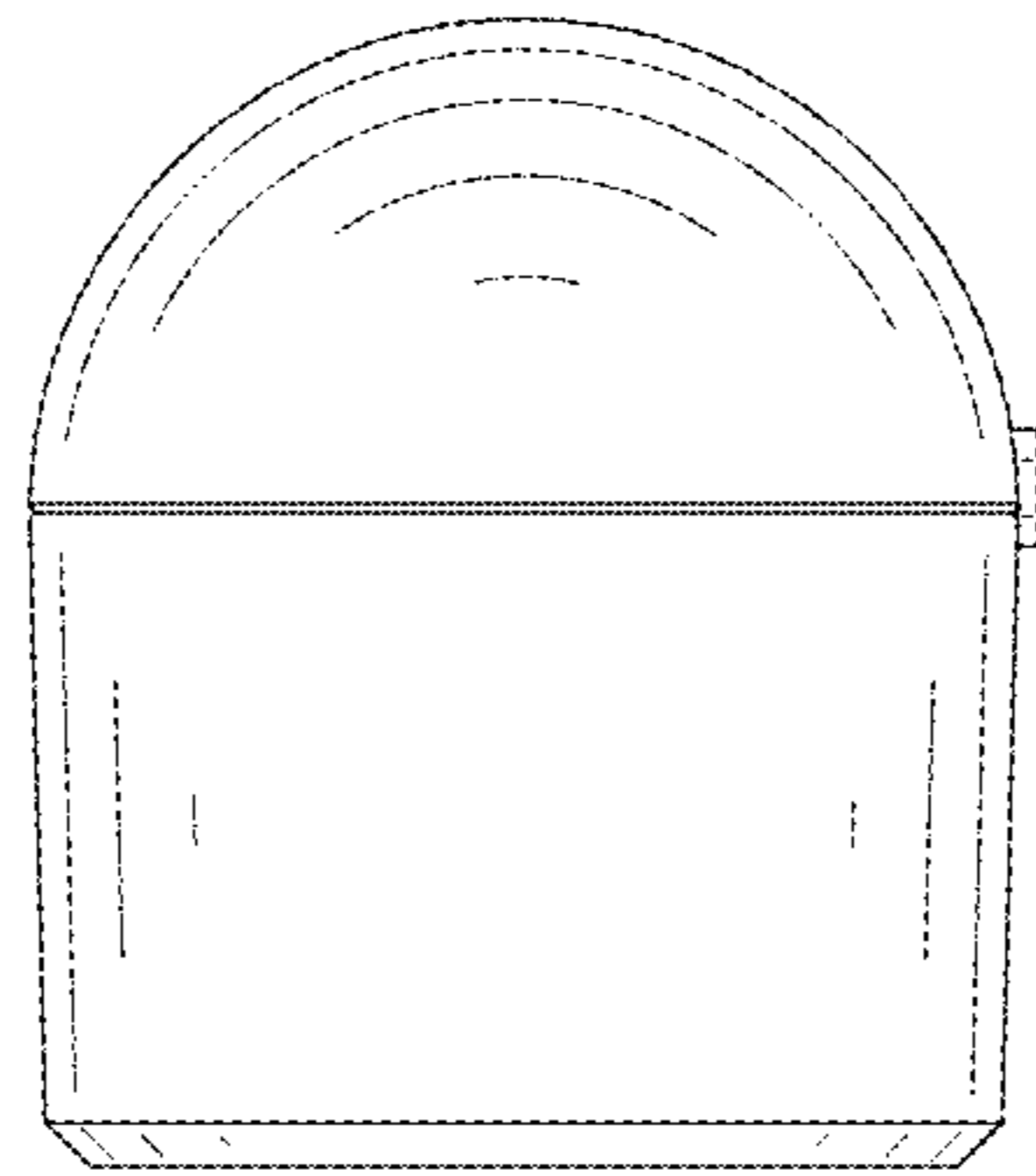

FIG.7



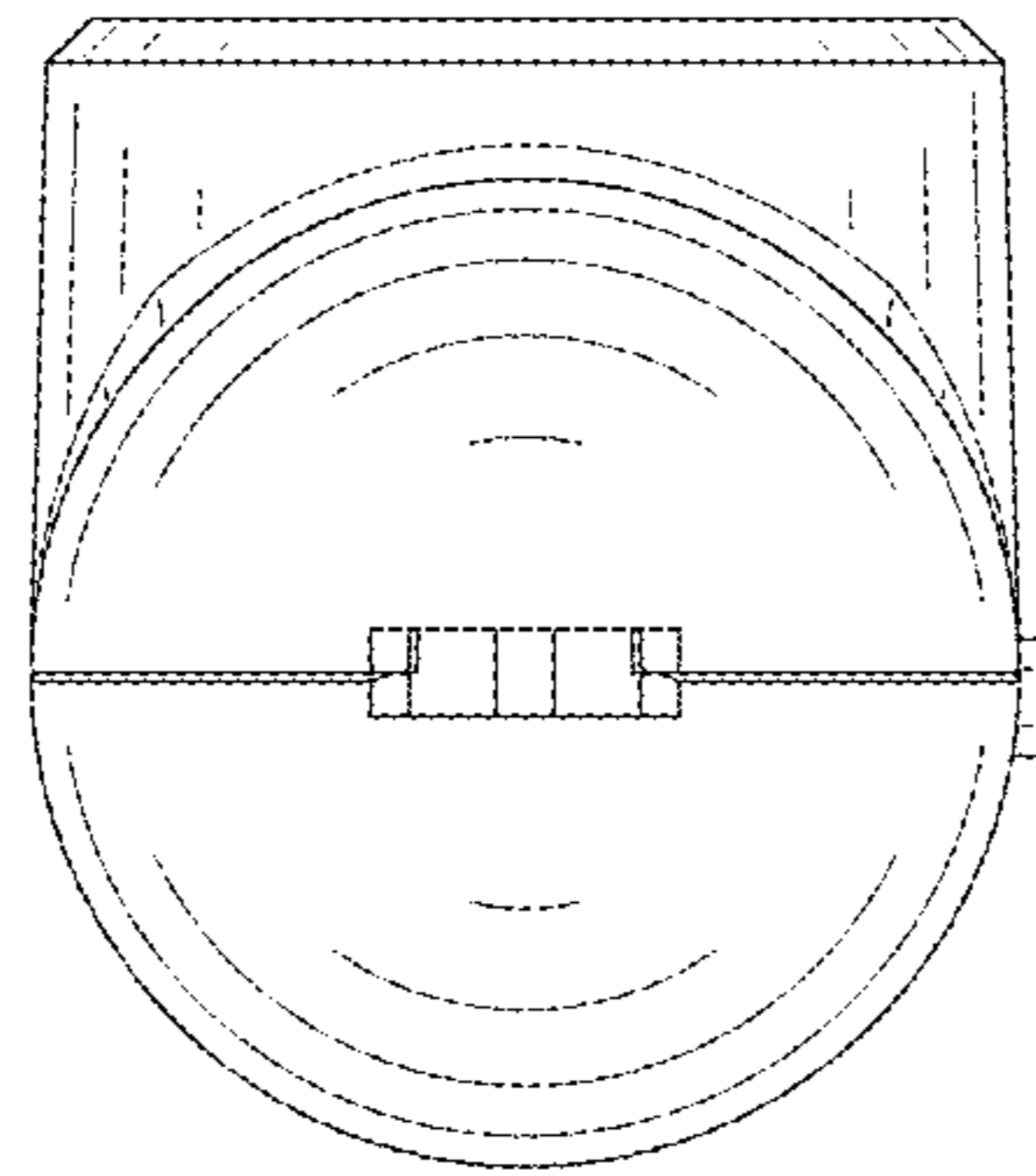

FIG.8