



US00D928299S

(12) **United States Design Patent** (10) **Patent No.:** **US D928,299 S**
Chen (45) **Date of Patent:** **** Aug. 17, 2021**

(54) **AIR PURIFIER** 23/1902; G05D 23/1931; G05B 19/0426;
G05B 19/409; G05B 15/02

(71) Applicant: **MIDEA GROUP CO., LTD.**, Foshan (CN) See application file for complete search history.

(72) Inventor: **Wei Chen**, Guangdong (CN)

(73) Assignee: **MIDEA GROUP CO., LTD.**, Foshan (CN)

(**) Term: **15 Years**

(21) Appl. No.: **35/509,183**

(22) Filed: **Dec. 10, 2019**

(80) **Hague Agreement Data**

Int. Filing Date: **Dec. 10, 2019**

Int. Reg. No.: **DM/207231**

Int. Reg. Date: **Dec. 10, 2019**

Int. Reg. Pub. Date: **Apr. 24, 2020**

(30) **Foreign Application Priority Data**

Aug. 26, 2019 (CN) 201930464612.X

(51) **LOC (13) Cl.** **23-04**

(52) **U.S. Cl.**
USPC **D23/364**

(58) **Field of Classification Search**
USPC D23/332, 333, 335, 336, 342, 351-366,
D23/388

CPC F24F 1/00; F24F 1/0007; F24F 1/02; F24F
1/08; F24F 1/42; F24F 1/56; F24F 1/60;
F24F 3/044; F24F 3/048; F24F 3/16;
F24F 11/30; F24F 11/32; F24F 11/46;
F24F 11/52; F24F 11/54; F24F 11/56;
F24F 11/58; F24F 11/59; F24F 11/61-64;
F24F 11/70; F24F 11/76; F24F 11/83;
F24F 11/85; F24F 11/88; F24F 11/89;
G05D 23/1905; G05D 23/1932; G05D

(56) **References Cited**

U.S. PATENT DOCUMENTS

D807,997 S *	1/2018	Seo	D23/364
D810,259 S *	2/2018	You	D23/364
D834,165 S *	11/2018	Maeng	D23/364
D835,248 S *	12/2018	Echeverri	D23/364
D841,783 S *	2/2019	Hu	D23/264
D844,766 S *	4/2019	Miao	D23/364
D862,673 S *	10/2019	Tang	D23/364
D876,598 S *	2/2020	Liu	D23/356
D876,599 S *	2/2020	He	D23/364
D882,743 S *	4/2020	Yang	D23/333
D889,621 S *	7/2020	Huang	D23/364
D890,904 S *	7/2020	Farone	D23/364
D905,840 S *	12/2020	Cao	D23/364

* cited by examiner

Primary Examiner — Natasha Vujcic

(74) *Attorney, Agent, or Firm* — Morgan, Lewis & Bockius LLP

(57) **CLAIM**

The ornamental design for an air purifier, as shown and described.

DESCRIPTION

- 1. Air purifier
- 1.1 : Front
- 1.2 : Back
- 1.3 : Left
- 1.4 : Right
- 1.5 : Top
- 1.6 : Bottom
- 1.7 : Perspective

1 Claim, 7 Drawing Sheets

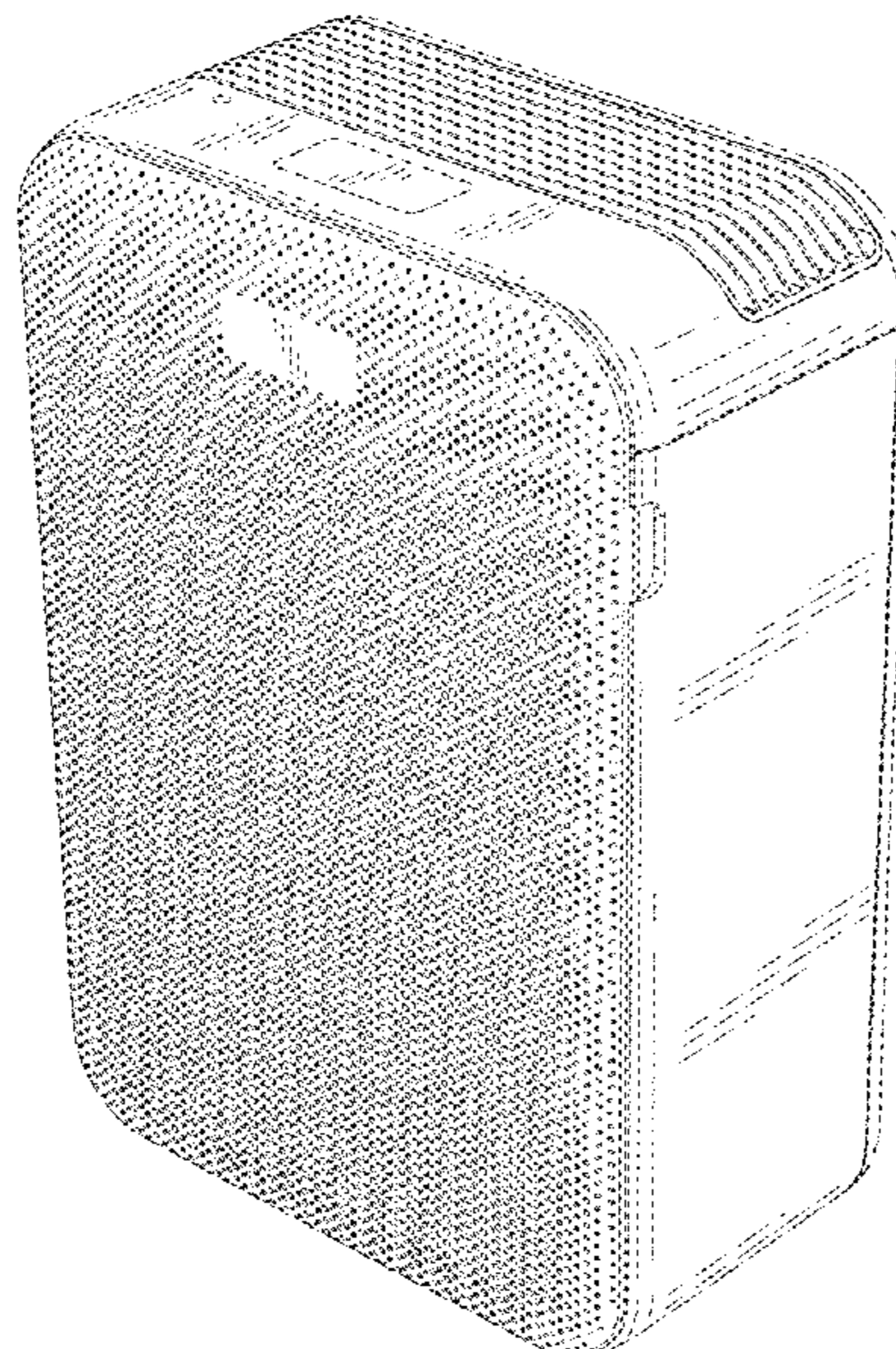

1.1

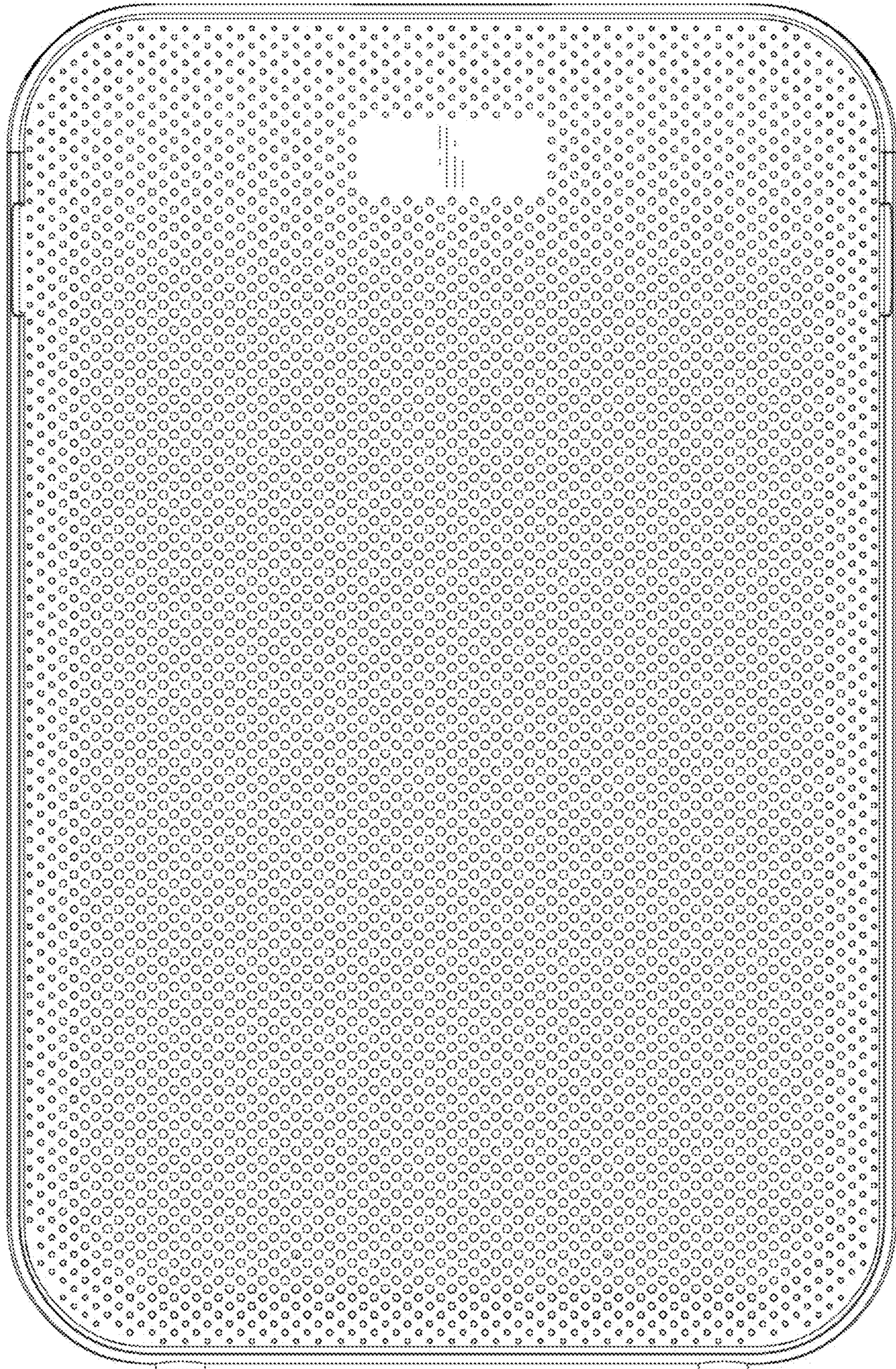

1.2

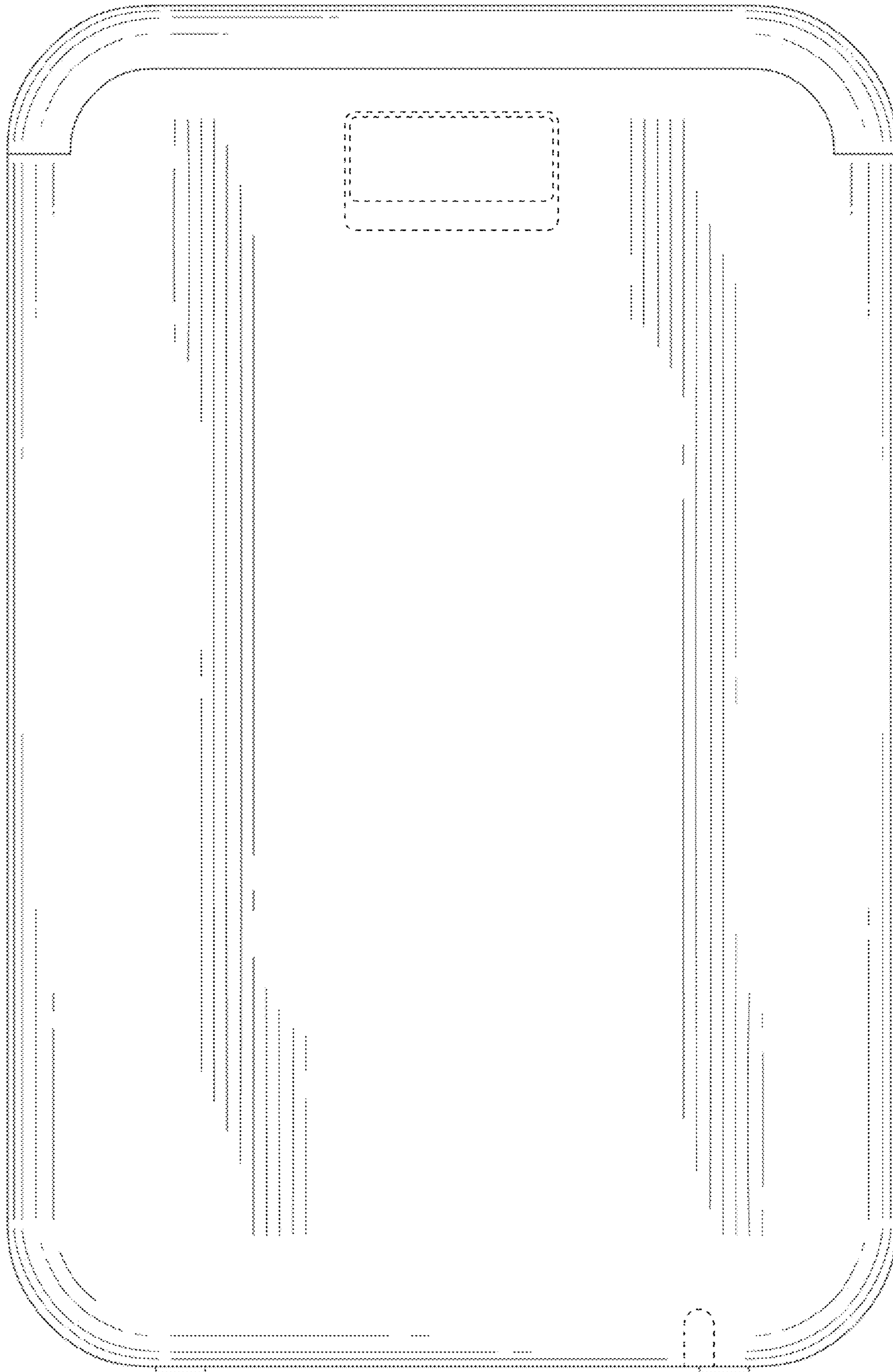

1.3

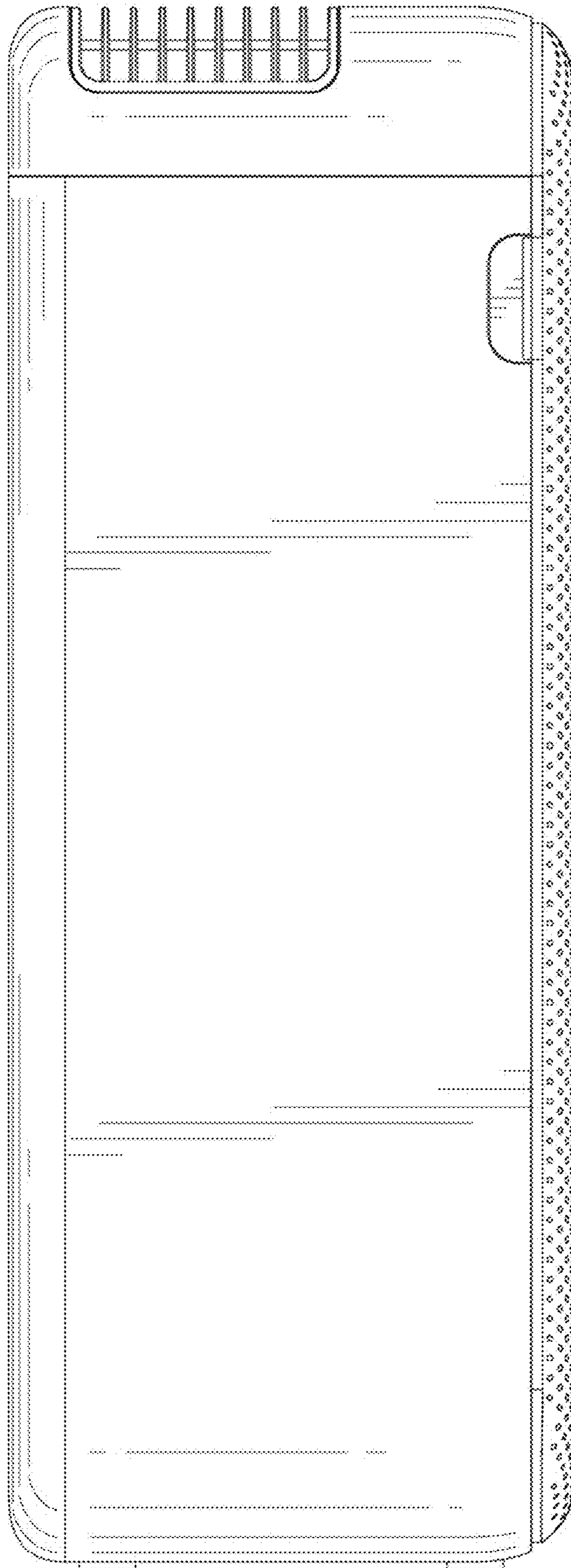

1.4

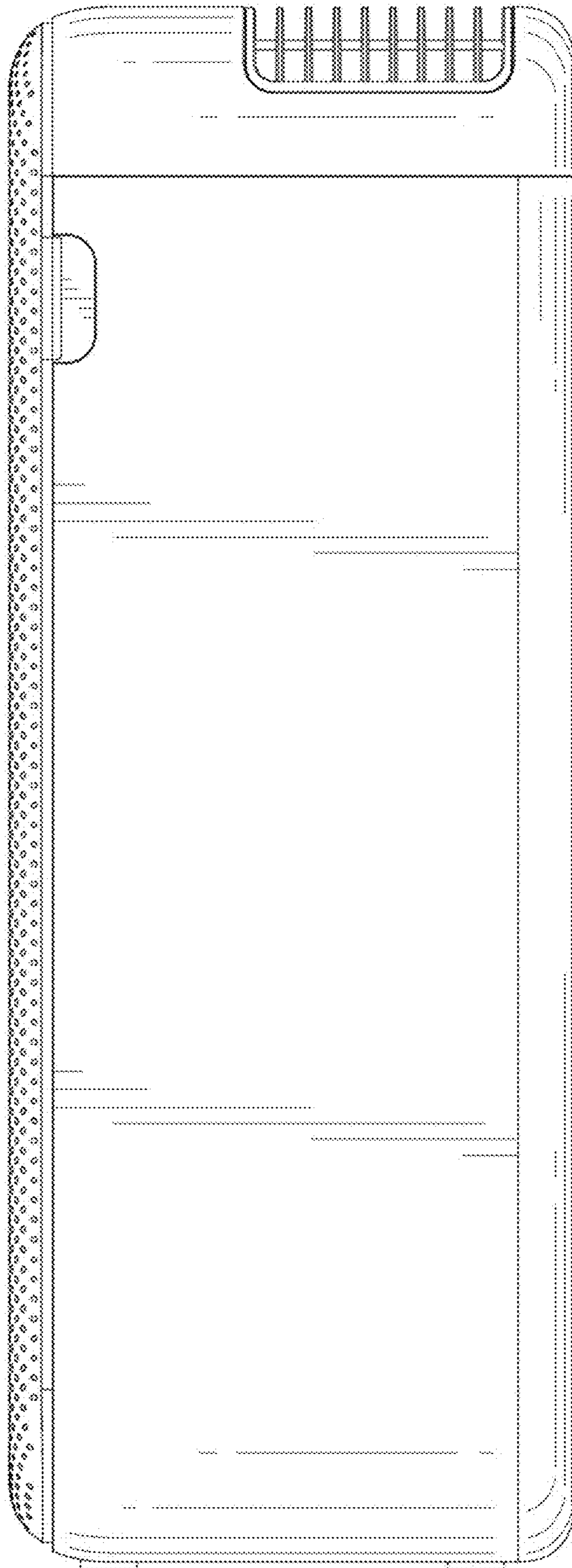

1.5

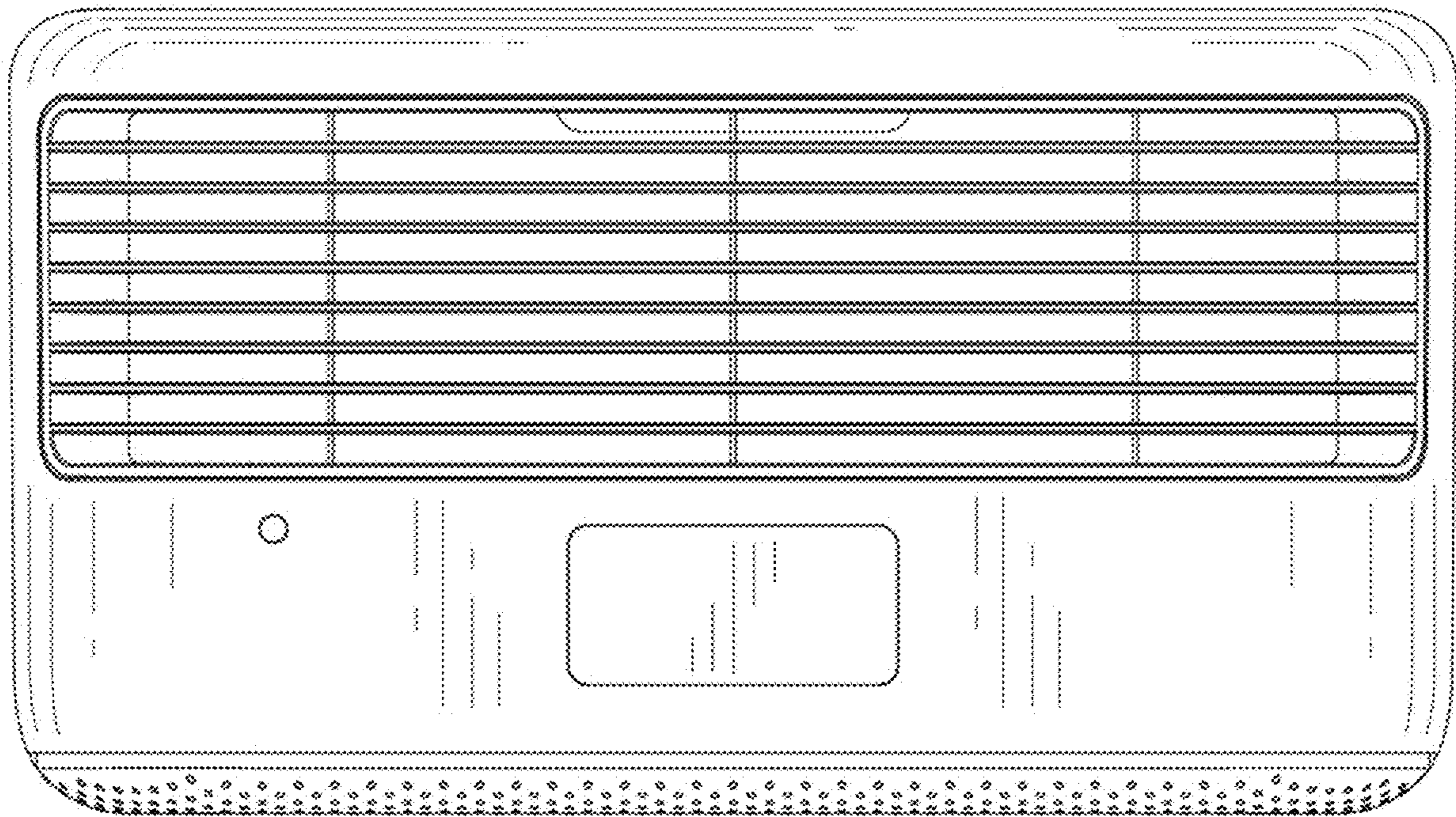

1.6

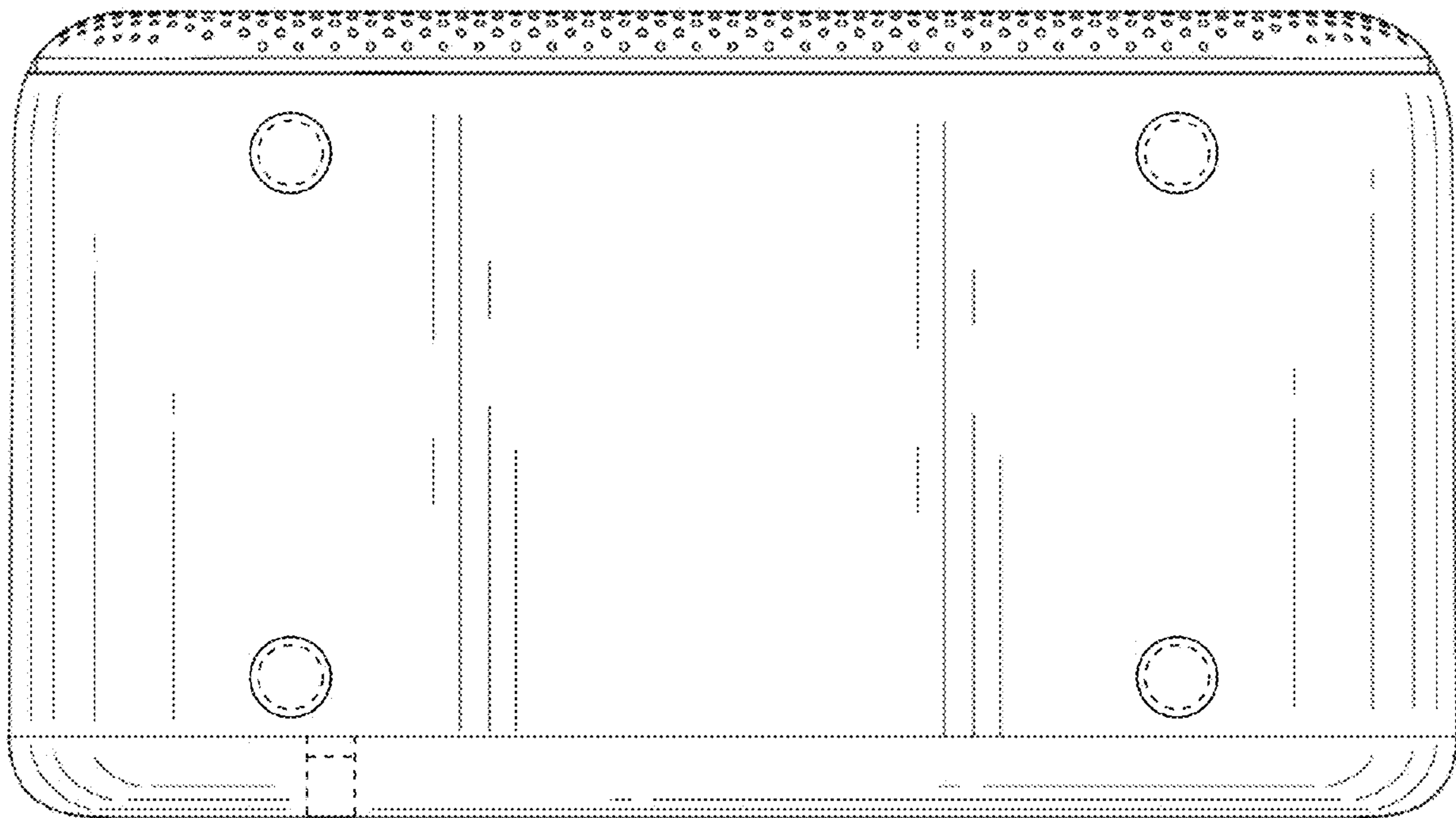

1.7

