



US00D928151S

(12) **United States Design Patent**
Hu

(10) **Patent No.:** **US D928,151 S**

(45) **Date of Patent:** **** Aug. 17, 2021**

(54) **VR HEAD STRAP WITH BATTERY PACK HOLDER**

(71) Applicant: **Liyin Hu**, Zhejiang (CN)

(72) Inventor: **Liyin Hu**, Zhejiang (CN)

(**) Term: **15 Years**

(21) Appl. No.: **29/778,625**

(22) Filed: **Apr. 14, 2021**

(51) **LOC (13) Cl.** **14-02**

(52) **U.S. Cl.**
USPC **D14/372**

(58) **Field of Classification Search**
USPC D14/372, 496, 432, 371, 125, 126, 129,
D14/299; D16/300-342; 351/158, 153,
351/144; 345/7-9, 905; 455/344;
348/115, 53, 121, 739
CPC G02B 27/017; G02B 27/0158; G02B
27/0161; G02B 27/0181; G02B 27/0185;
G02B 27/0189

See application file for complete search history.

(56) **References Cited**

U.S. PATENT DOCUMENTS

D484,875 S 1/2004 Higgins
D812,278 S 3/2018 Pontano

D881,879 S * 4/2020 Keller D14/372
D885,383 S * 5/2020 Chang D14/372
D889,464 S * 7/2020 Wang D14/372
D894,181 S * 8/2020 Kitakami D14/372
D904,402 S * 12/2020 Marquis D14/372
D905,779 S * 12/2020 Jeon D16/208
D916,702 S * 4/2021 Newsom D14/372
D920,974 S * 6/2021 Chi D14/372

* cited by examiner

Primary Examiner — Austin Murphy

(74) *Attorney, Agent, or Firm* — ScienBiziP, P.C.

(57) **CLAIM**

The ornamental design for a VR head strap with battery pack holder, as shown and described.

DESCRIPTION

FIG. 1 is a front, right, and top perspective view of a VR head strap with battery pack holder, showing my design.

FIG. 2 is a front elevation view thereof.

FIG. 3 is a rear elevation view thereof.

FIG. 4 is a left side elevation view thereof.

FIG. 5 is a right side elevation view thereof.

FIG. 6 is a top plan view thereof; and,

FIG. 7 is a bottom plan view thereof.

The broken lines shown in the drawings are included for the purpose of illustrating portions of the VR head strap with battery pack holder that form no part of the claimed design.

1 Claim, 7 Drawing Sheets

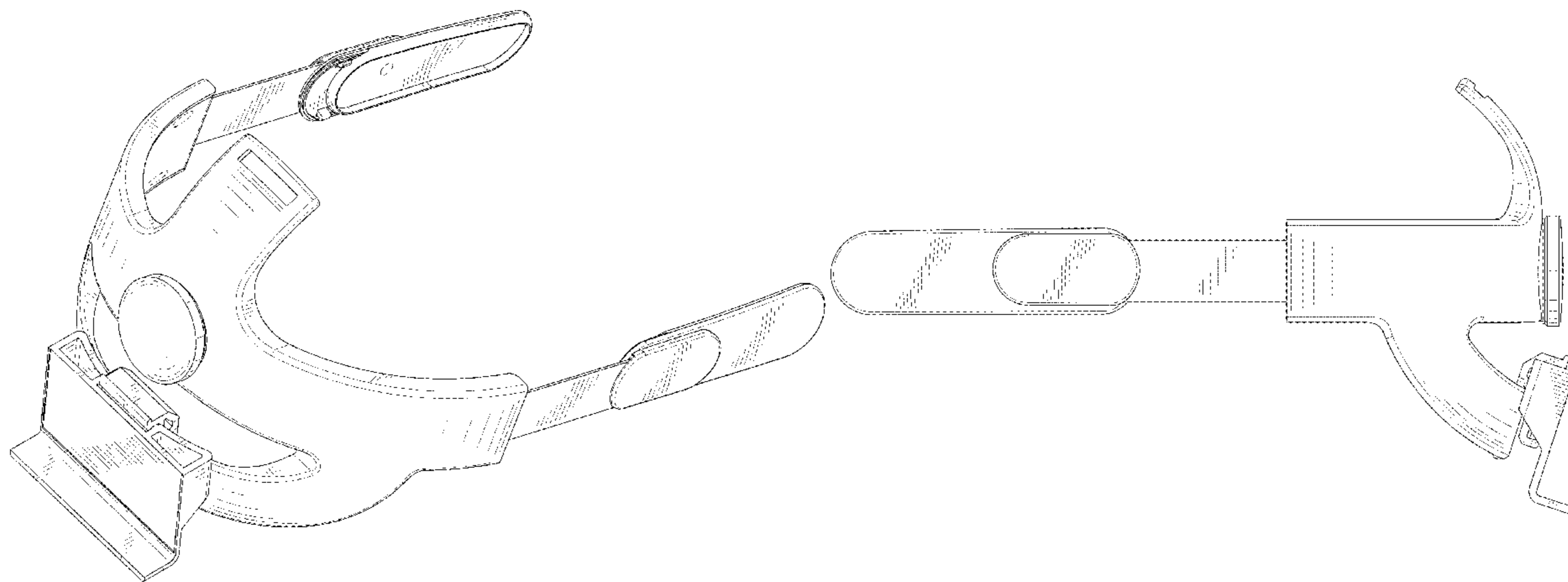

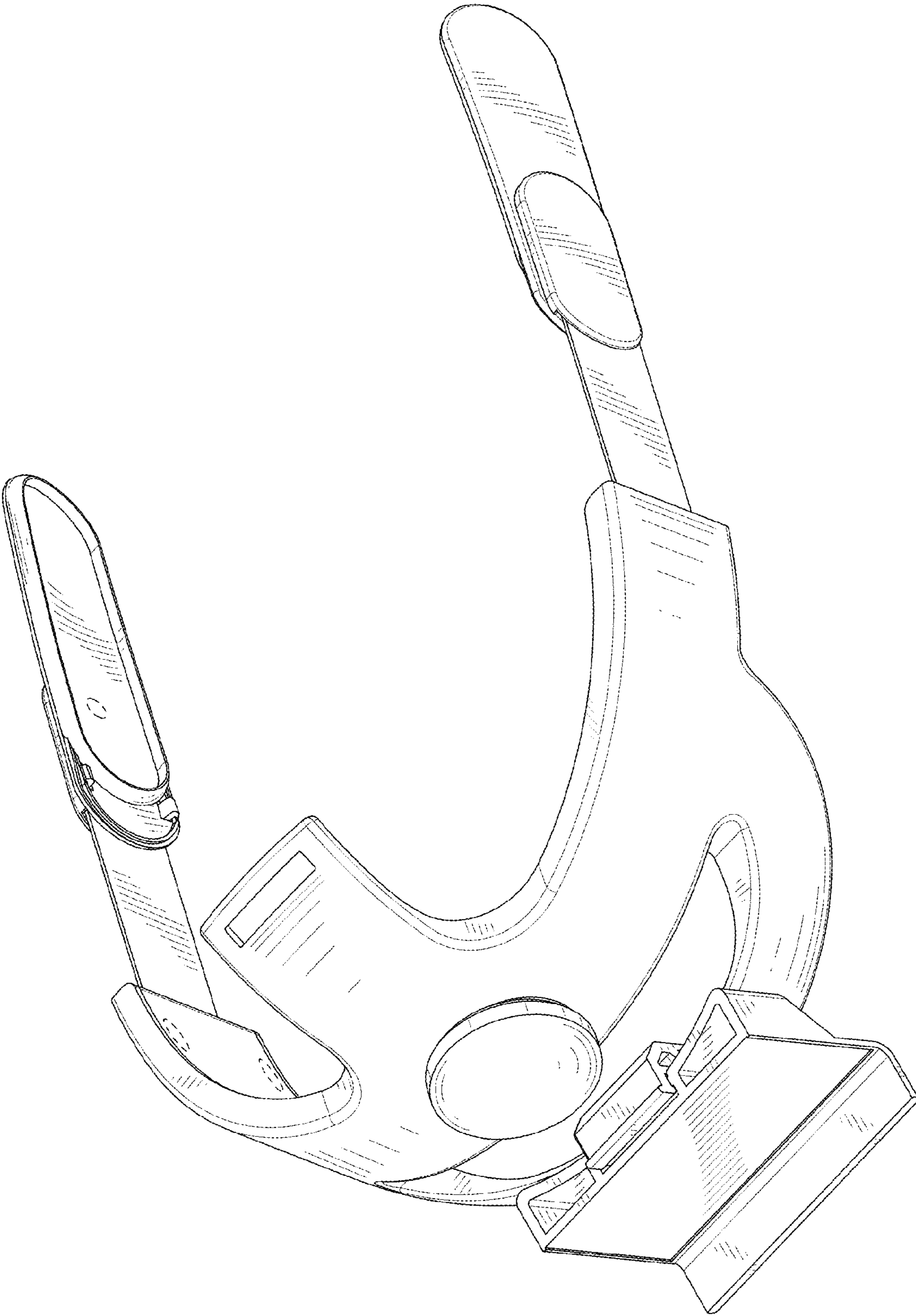

FIG. 1

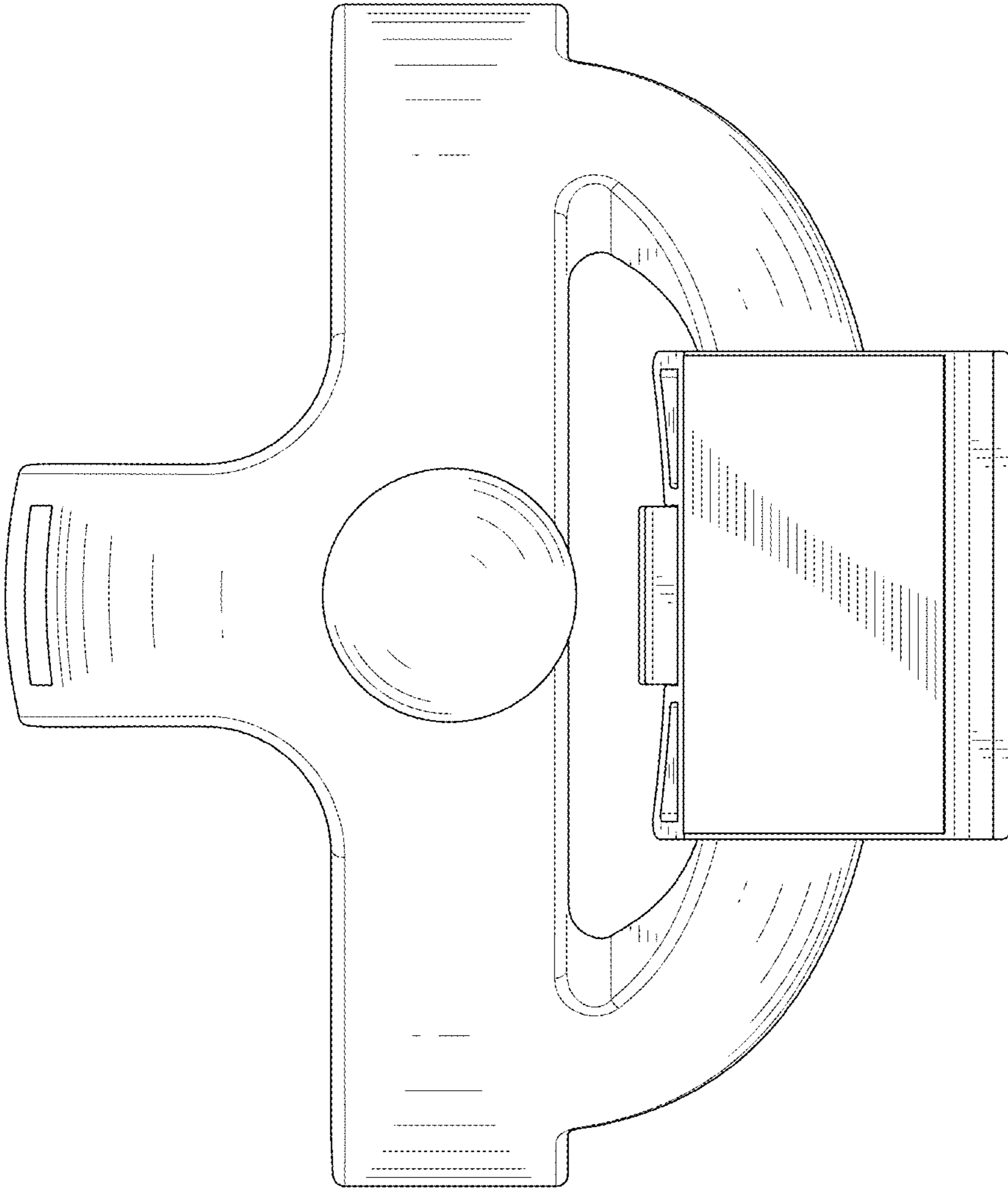

FIG. 2

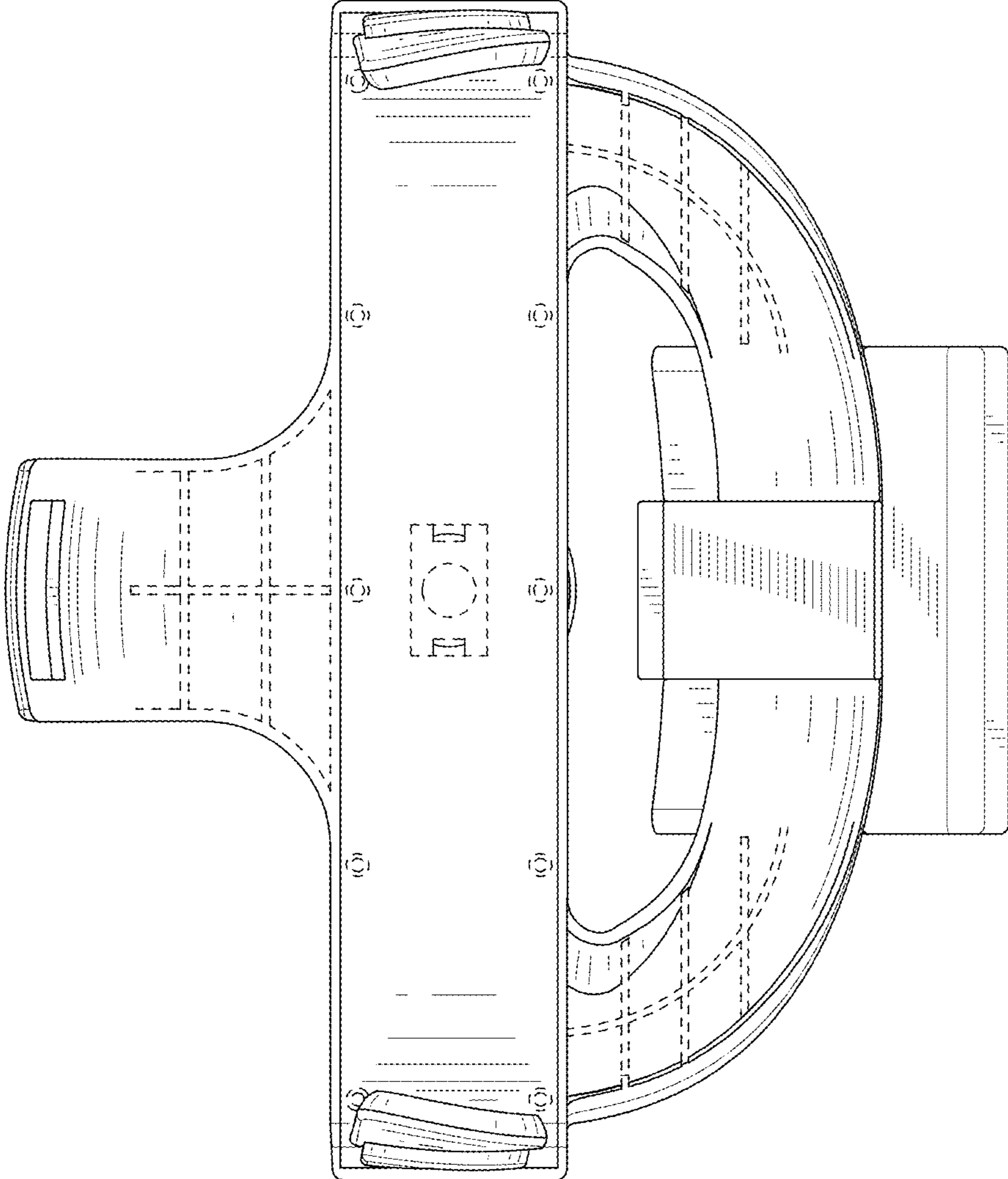

FIG. 3

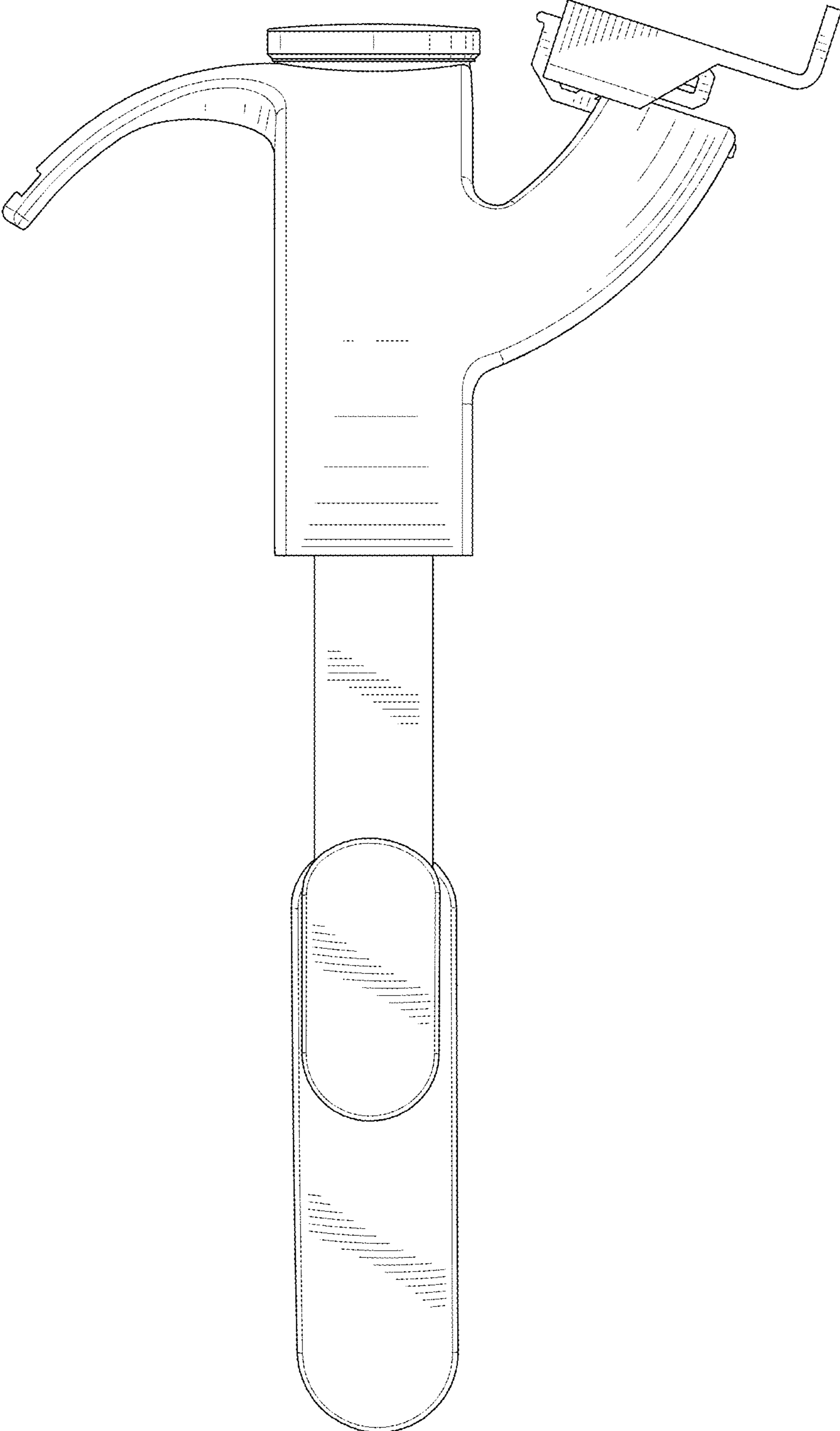

FIG. 4

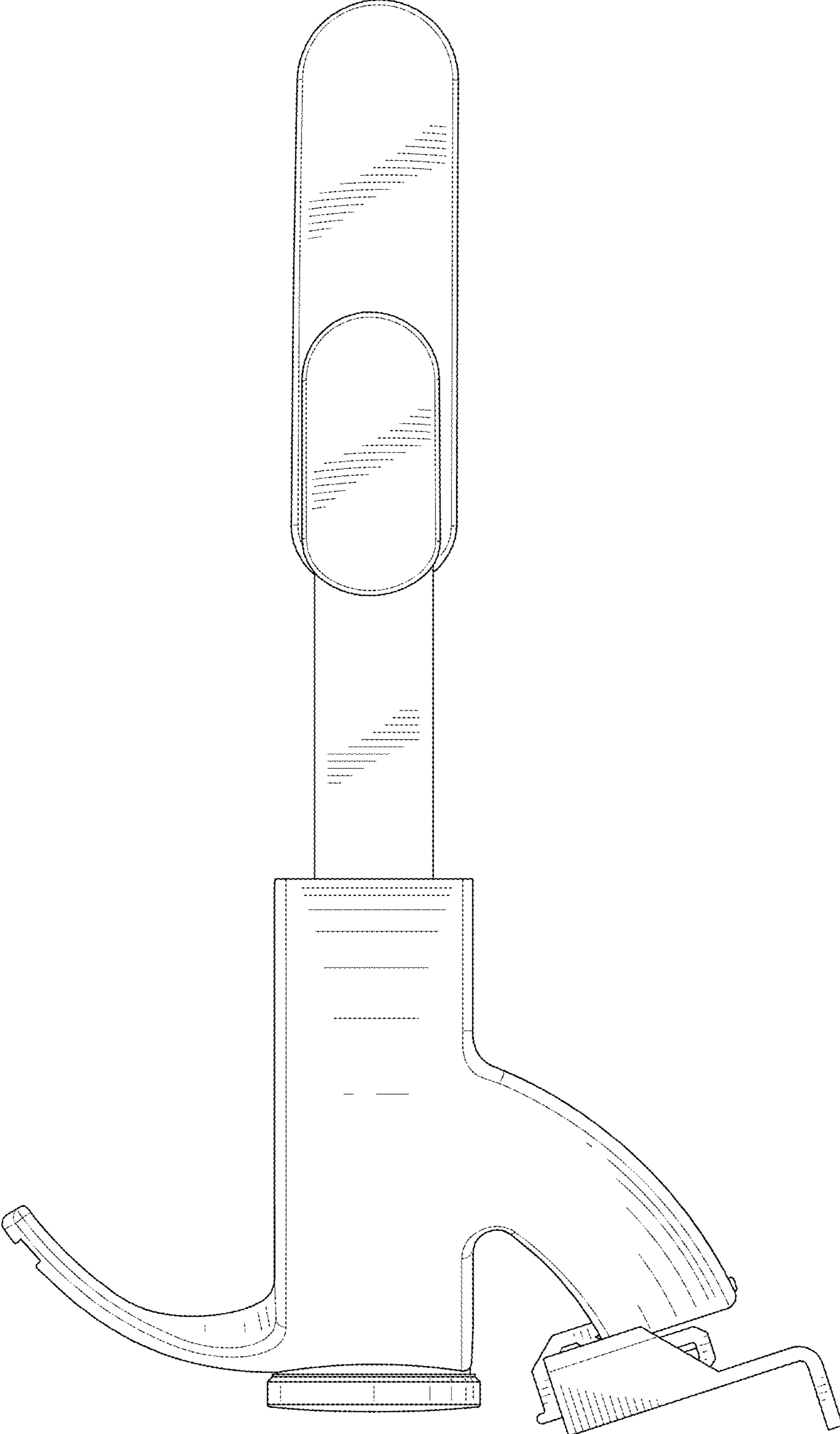

FIG. 5

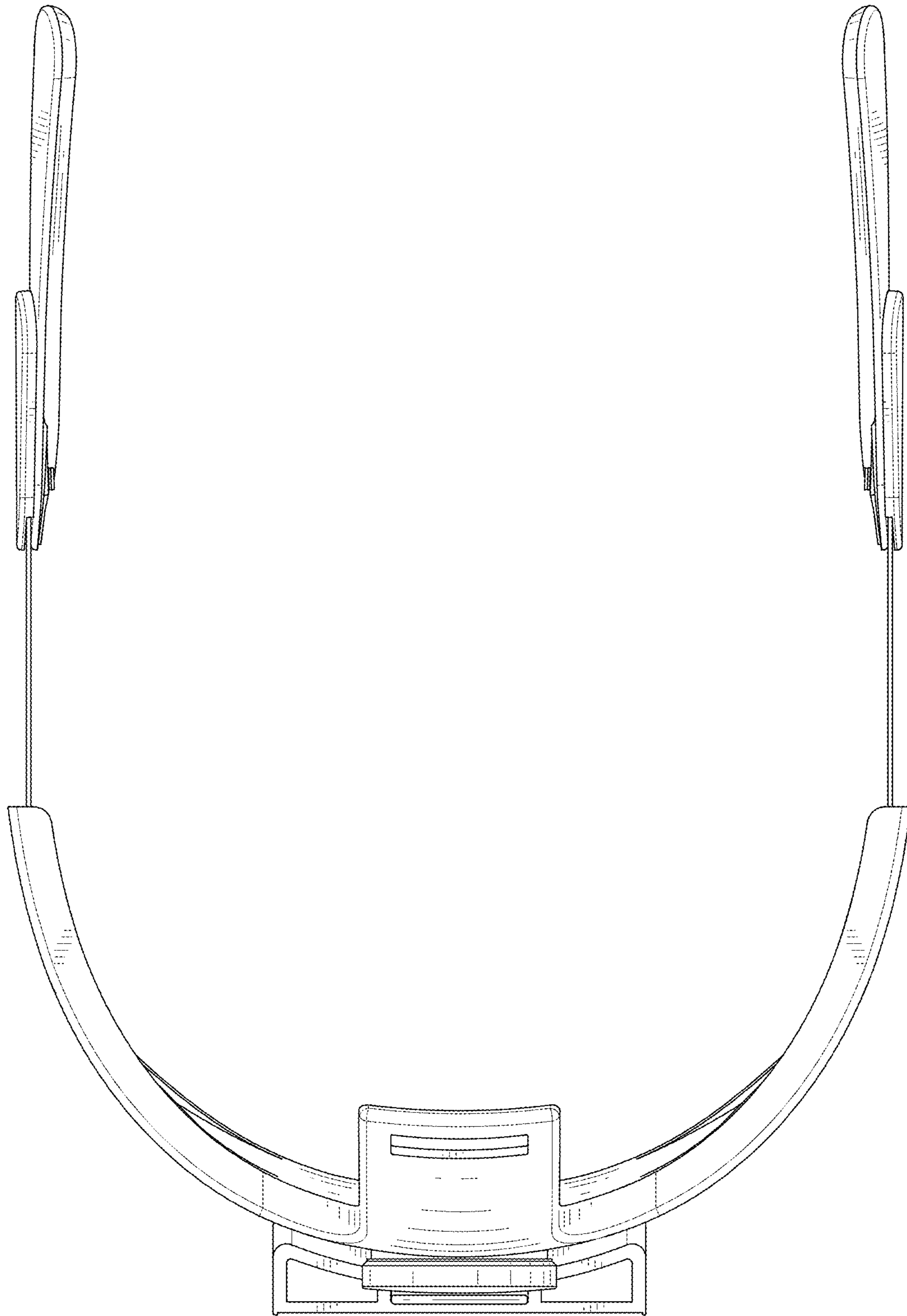

FIG. 6

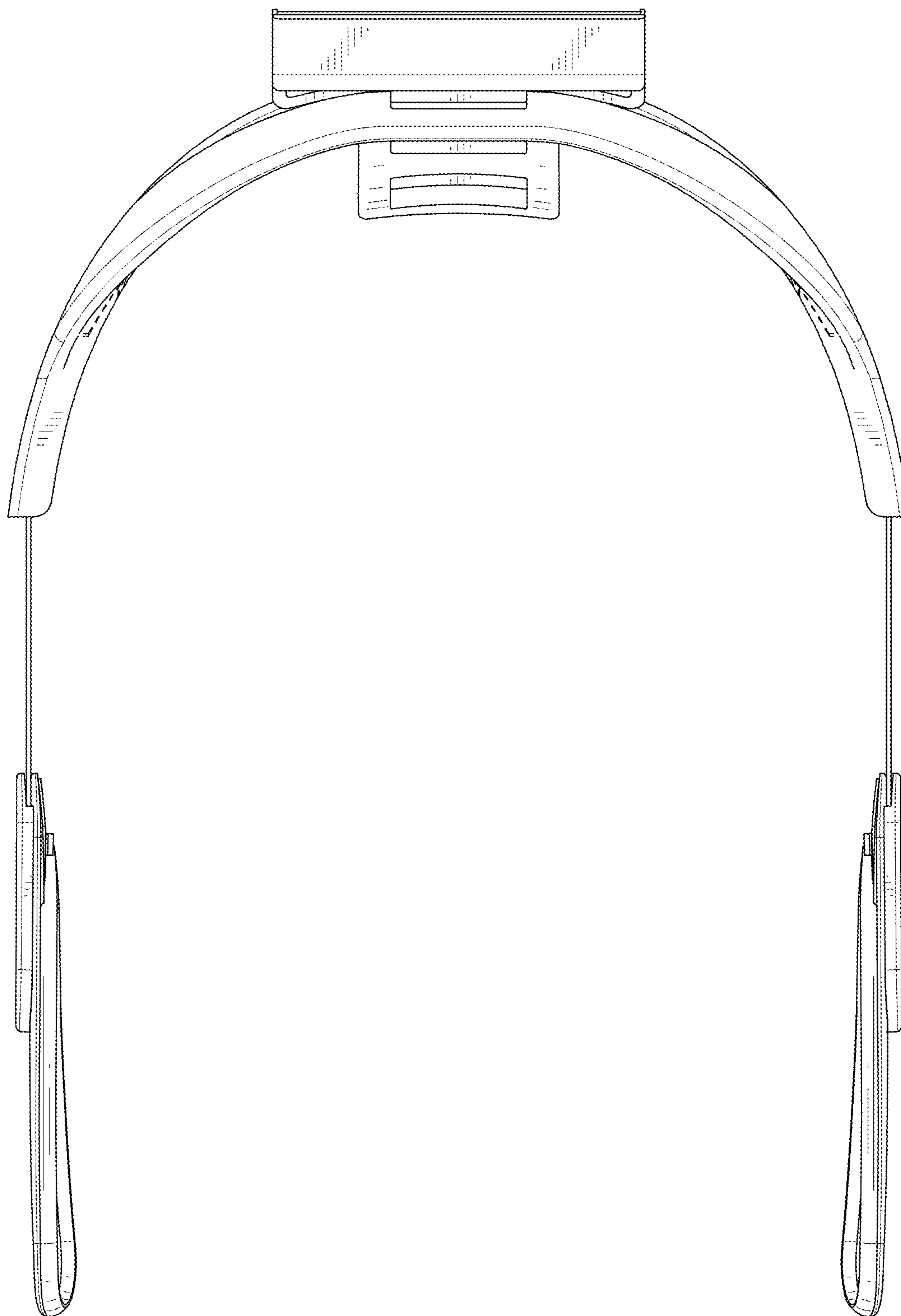

FIG. 7