



US00D928030S

(12) **United States Design Patent** (10) **Patent No.:** **US D928,030 S**
Barile (45) **Date of Patent:** **** Aug. 17, 2021**

(54) **FLOWERPOT**
(71) Applicant: **GABE S.R.L.**, Terlizzi (IT)
(72) Inventor: **Gioacchino Barile**, Terlizzi (IT)
(**) Term: **15 Years**
(21) Appl. No.: **29/724,287**
(22) Filed: **Feb. 13, 2020**
(51) **LOC (13) Cl.** **11-02**
(52) **U.S. Cl.**
USPC **D11/151**
(58) **Field of Classification Search**
USPC D11/143–156, 164; D7/560, 561, 562,
D7/586, 587; D9/663, 430
CPC A01G 9/02; A01G 9/021; A01G 9/022;
A01G 9/04; A01G 27/003; A01G 27/005;
A01G 27/008; A47G 7/00; A47G 7/02;
A47G 7/06; A47G 7/08
See application file for complete search history.

(56) **References Cited**

U.S. PATENT DOCUMENTS

231,086 A * 8/1880 Pimley A47G 7/047
47/67
986,395 A * 3/1911 King A01G 9/28
47/33
1,335,613 A * 3/1920 Selle F16B 35/041
411/368
D99,783 S * 5/1936 Duryea D11/147
D103,122 S * 2/1937 Mogi D9/663
2,148,959 A * 2/1939 Pavlecka F16B 39/34
411/302
D152,495 S * 1/1949 Potts D27/188
2,908,112 A * 10/1959 Koistinen A47G 7/00
47/41.11
3,137,095 A * 6/1964 Pearson A01G 9/023
47/83
D209,240 S * 11/1967 Plogsted D9/755

D262,611 S * 1/1982 Gonzales D11/143
4,355,485 A * 10/1982 Frank A01G 9/023
47/82
D318,797 S * 8/1991 Cohen D9/663
D343,509 S * 1/1994 Scott, Jr. D8/1
D408,594 S * 4/1999 Nakano D28/91
D599,634 S * 9/2009 Taylor, Jr. D8/29
D682,115 S * 5/2013 Dumas D9/663
D700,058 S * 2/2014 Faillant Dumas D9/663
D714,596 S * 10/2014 Forno D8/1
D736,645 S * 8/2015 Gomez D9/663
9,272,812 B2 * 3/2016 Shuert B65D 19/18
D792,276 S * 7/2017 Burnette D11/143
10,178,908 B1 * 1/2019 Tseng A47B 47/0091
D893,222 S * 8/2020 Tseng D6/678
D901,307 S * 11/2020 Ha D9/663
D912,678 S * 3/2021 O'Donnell D14/445
2012/0279155 A1 * 11/2012 Mortreuil A01G 9/28
52/379

* cited by examiner

Primary Examiner — Elizabeth A. Albert

(57) **CLAIM**

The ornamental design for a flowerpot, as shown and described.

DESCRIPTION

FIG. 1 is a top view of a flowerpot showing my new design. FIG. 2 is a first perspective view thereof; FIG. 3 is a second perspective view thereof; FIG. 4 is a front view thereof; FIG. 5 is a right side view thereof; FIG. 6 is a rear view thereof; FIG. 7 is a left side view thereof; and, FIG. 8 is a bottom view thereof. The broken lines in FIG. 8 illustrate portions of the flowerpot that form no part of the claimed design.

1 Claim, 3 Drawing Sheets

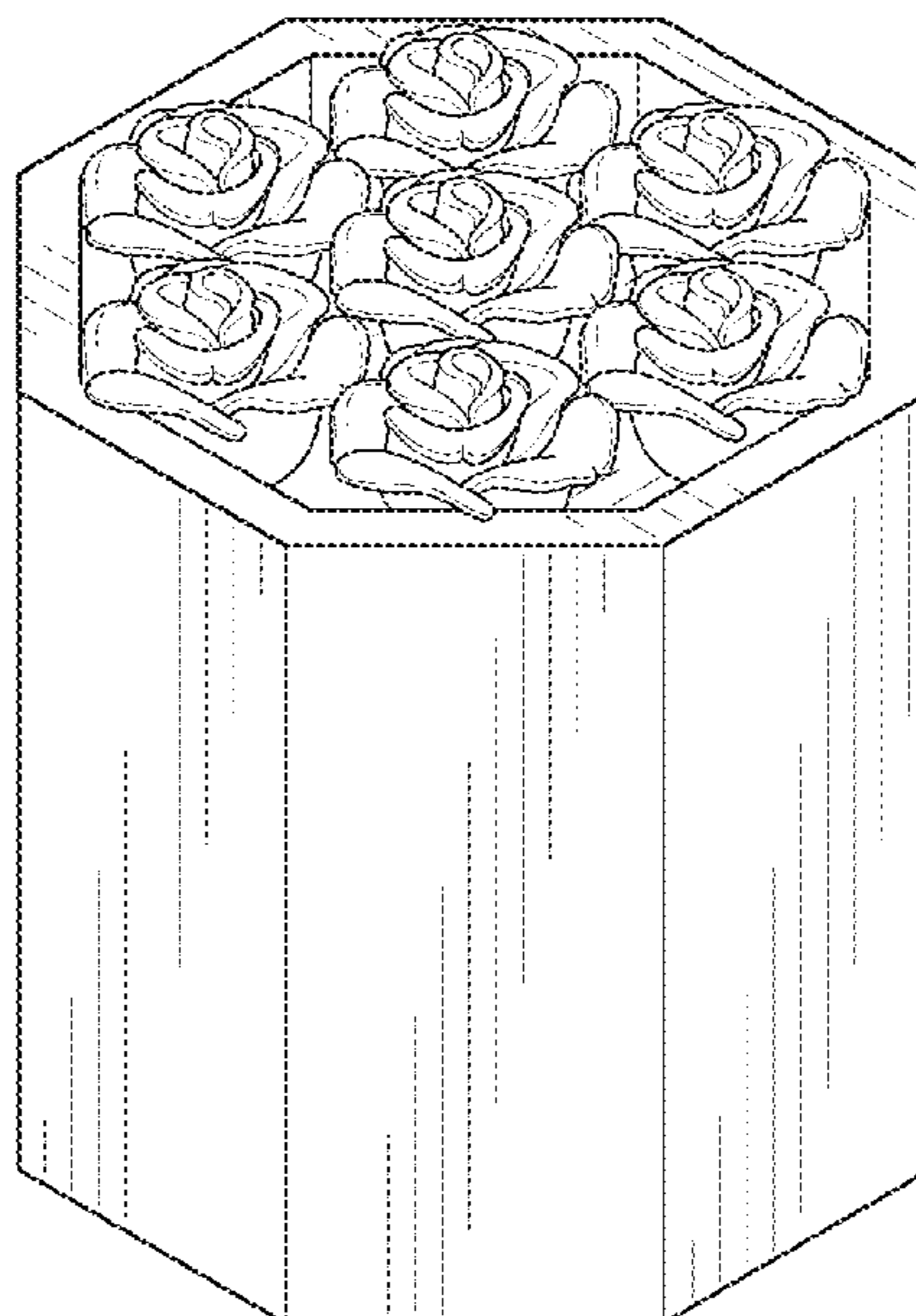

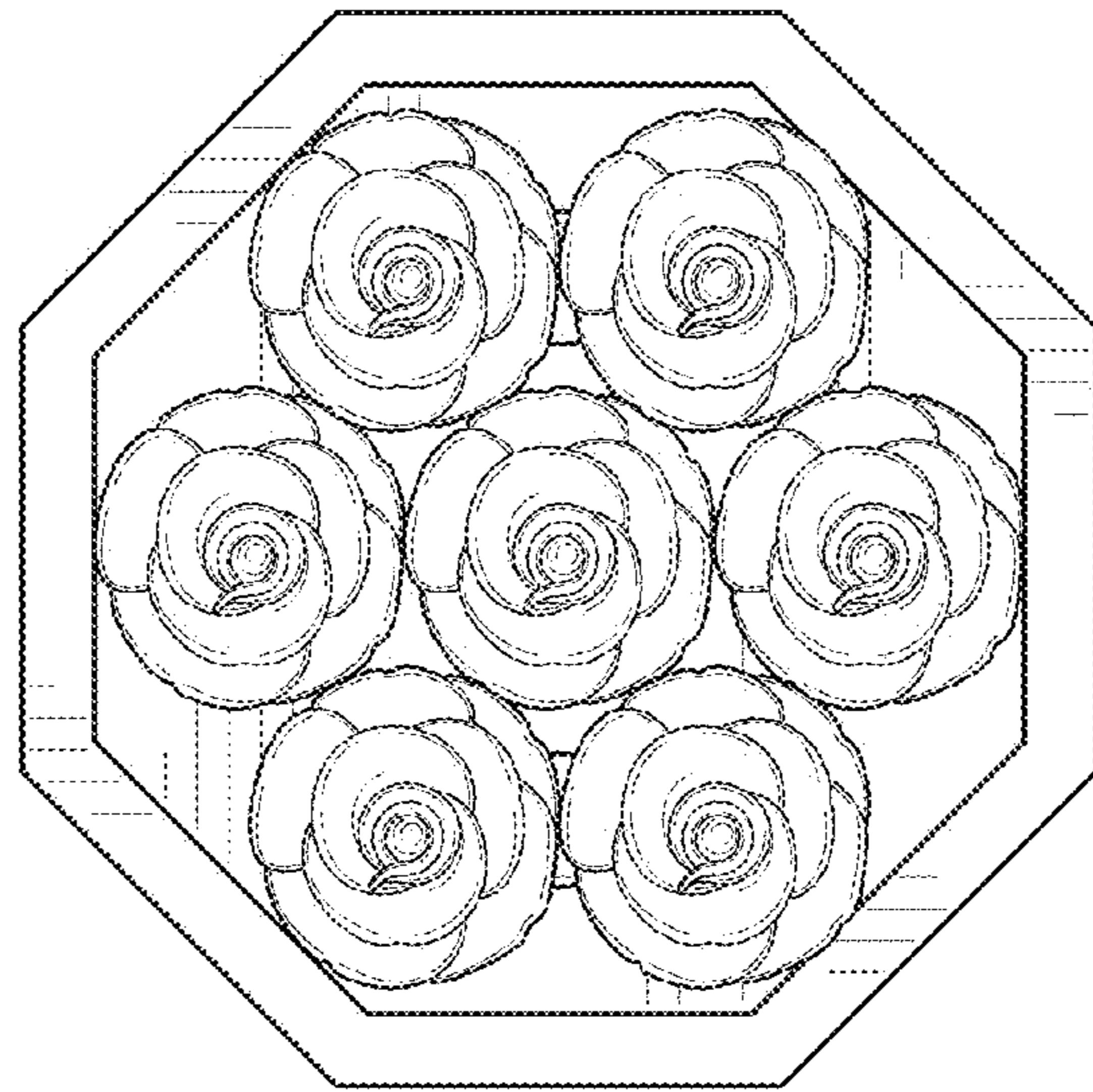

FIG. 1

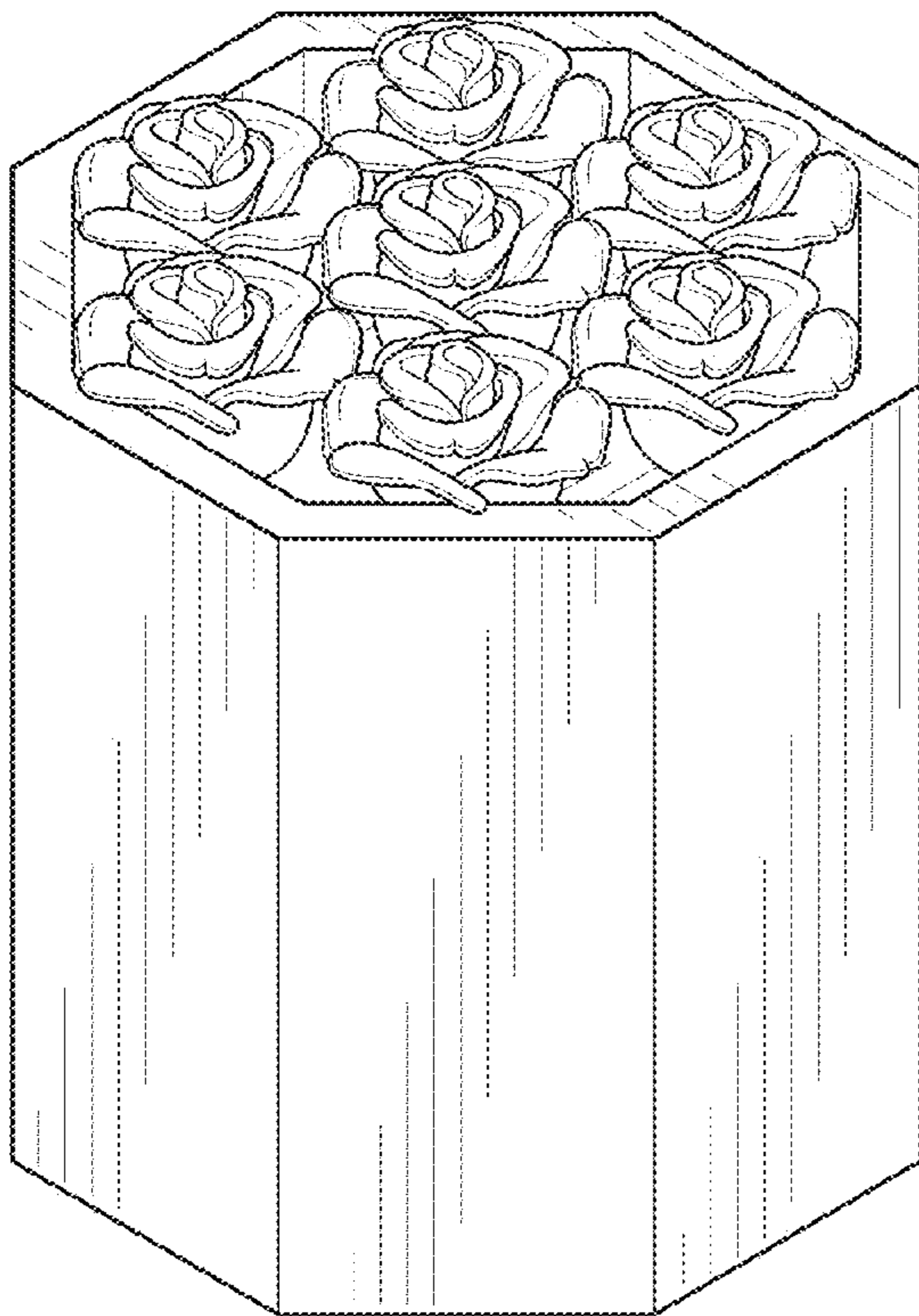

FIG. 2

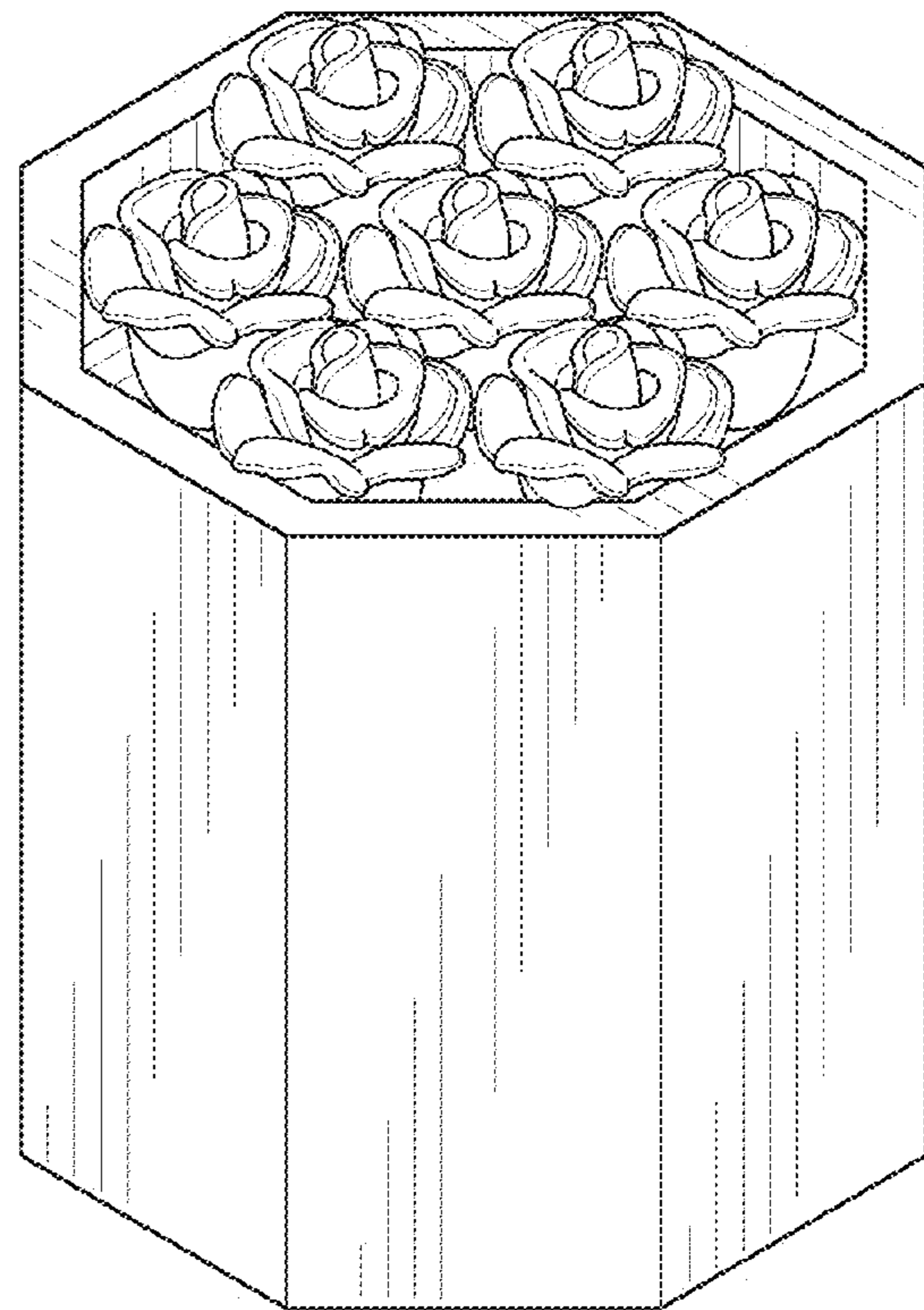

FIG. 3

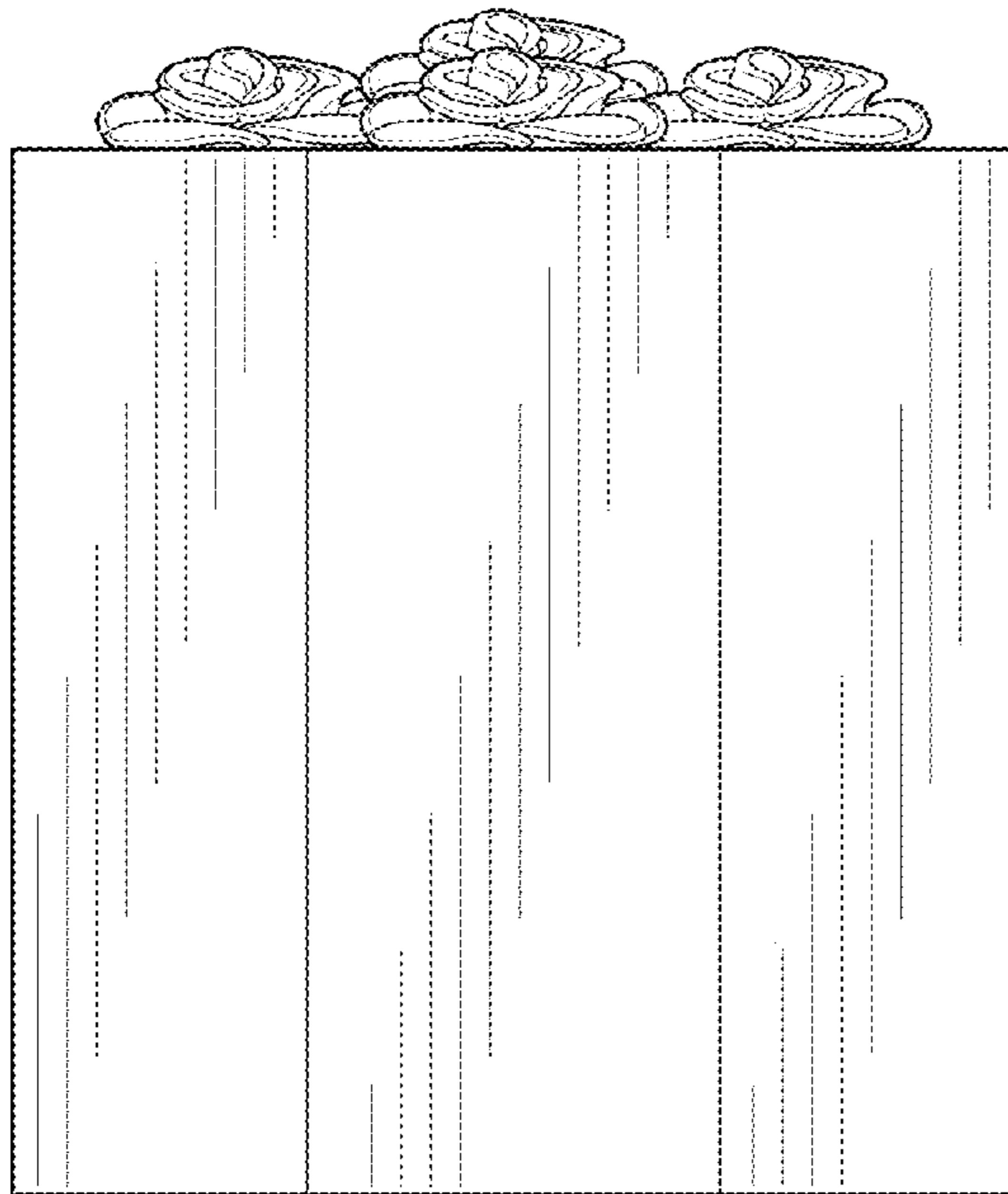

FIG. 4

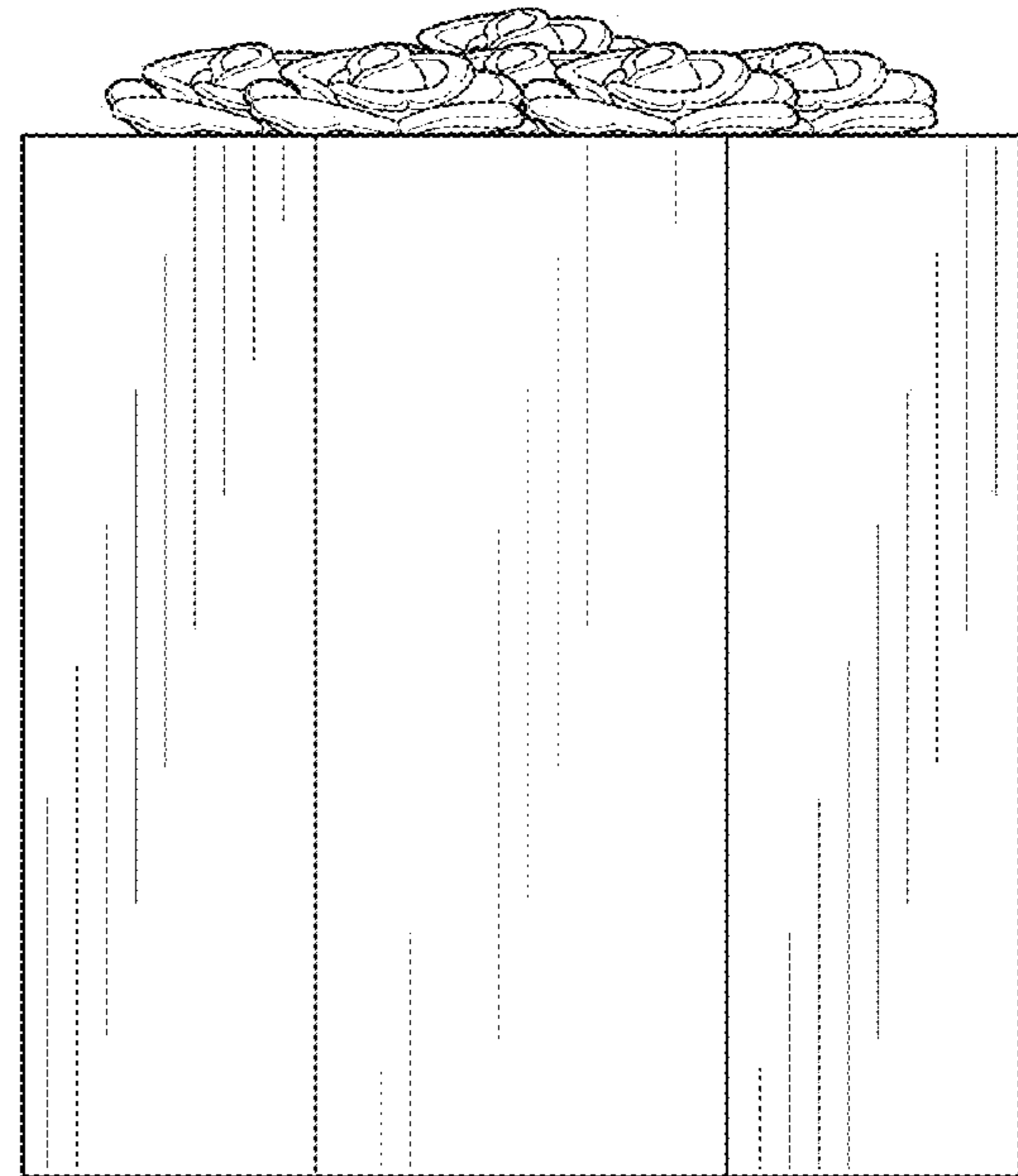

FIG. 5

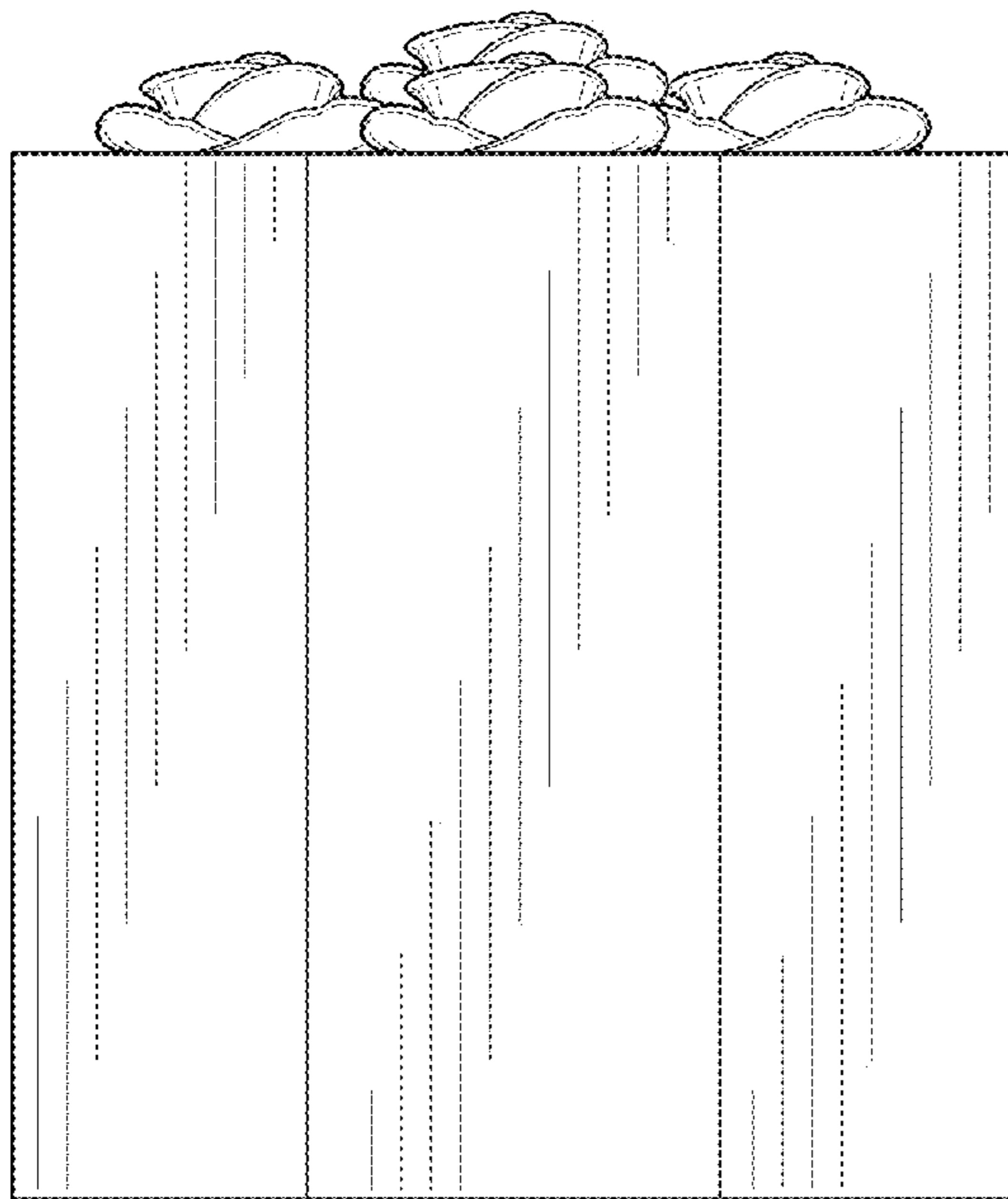

FIG. 6

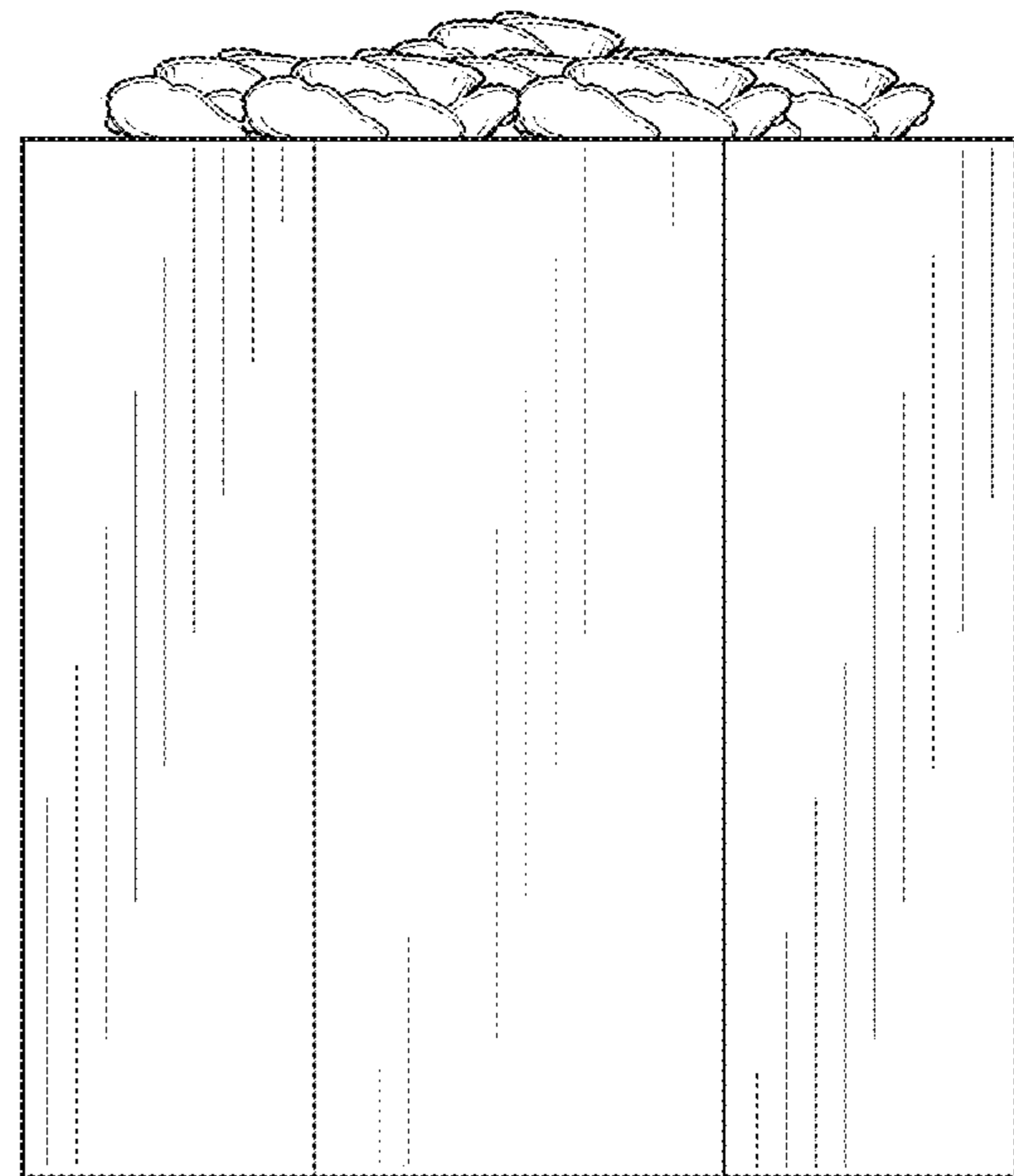

FIG. 7

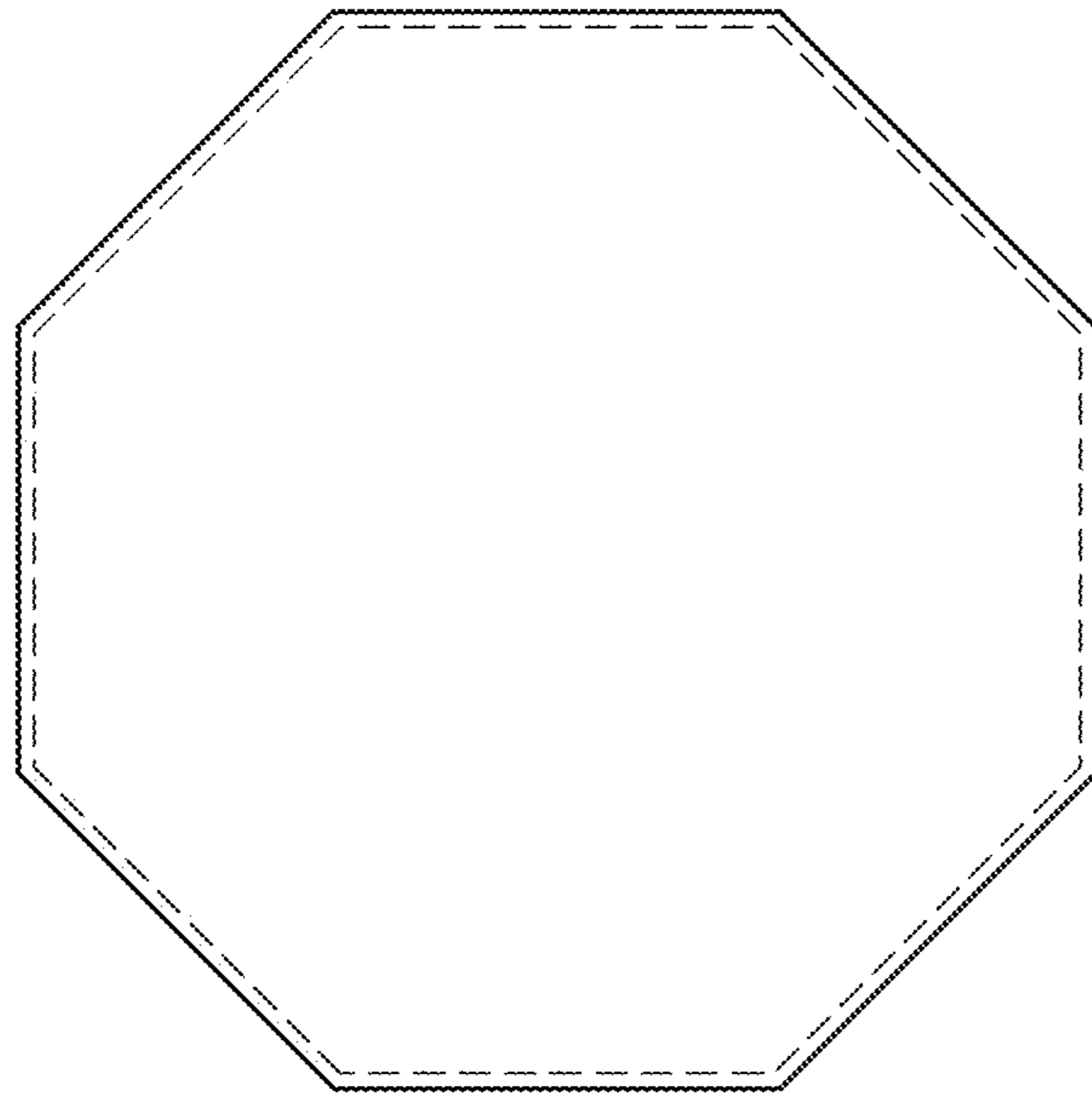

FIG. 8