



US00D927908S

(12) **United States Design Patent**
Chen

(10) **Patent No.:** **US D927,908 S**

(45) **Date of Patent:** **** Aug. 17, 2021**

(54) **SEAT BACK**

(71) Applicant: **Yucheng Chen**, Guangzhou (CN)

(72) Inventor: **Yucheng Chen**, Guangzhou (CN)

(**) Term: **15 Years**

(21) Appl. No.: **29/734,485**

(22) Filed: **May 13, 2020**

(30) **Foreign Application Priority Data**

Apr. 24, 2020 (CN) 202030173255.4

(51) **LOC (13) Cl.** **06-06**

(52) **U.S. Cl.**
USPC **D6/716.4**

(58) **Field of Classification Search**
USPC D6/334, 346, 349, 355, 360, 361, 362,
D6/363, 364, 365, 366, 367, 368, 371,
D6/372, 374, 375, 379, 380, 716.4
CPC A47C 3/00; A47C 3/12; A47C 3/20; A47C
3/32; A47C 1/00; A47C 1/022; A47C
1/024; A47C 1/04; A47C 1/06; A47C
7/24; A47C 7/36; A47C 7/46; A47C 7/18;
A47C 7/40; A47C 17/02
See application file for complete search history.

(56) **References Cited**

U.S. PATENT DOCUMENTS

D704,946 S * 5/2014 Wu D6/366
D801,741 S * 11/2017 Zhu D6/716

D841,997 S * 3/2019 Chen D6/366
D888,450 S * 6/2020 Zhou D6/366
D907,947 S * 1/2021 Wang D6/716
D912,416 S * 3/2021 Chen D6/366
D912,418 S * 3/2021 Chen D6/366
D912,421 S * 3/2021 Chen D6/366
D913,004 S * 3/2021 Chen D6/366
2005/0189810 A1 * 9/2005 Wu A47C 7/38
297/452.29
2011/0215623 A1 * 9/2011 Tsai A47C 7/405
297/301.1
2020/0345142 A1 * 11/2020 Battey A47C 7/54

* cited by examiner

Primary Examiner — R. Johnson

(57) **CLAIM**

The ornamental design for a seat back, as shown and described.

DESCRIPTION

FIG. 1 is a perspective view of a seat back showing my new design;
FIG. 2 is another perspective view thereof;
FIG. 3 is a front elevational view thereof
FIG. 4 is a rear elevational view thereof;
FIG. 5 is a left side elevational view thereof;
FIG. 6 is a right side elevational view thereof;
FIG. 7 is a top plan view thereof; and,
FIG. 8 is a bottom plan view thereof.
The broken lines in the drawings depict portions of the seat back that form no part of the claimed design.

1 Claim, 8 Drawing Sheets

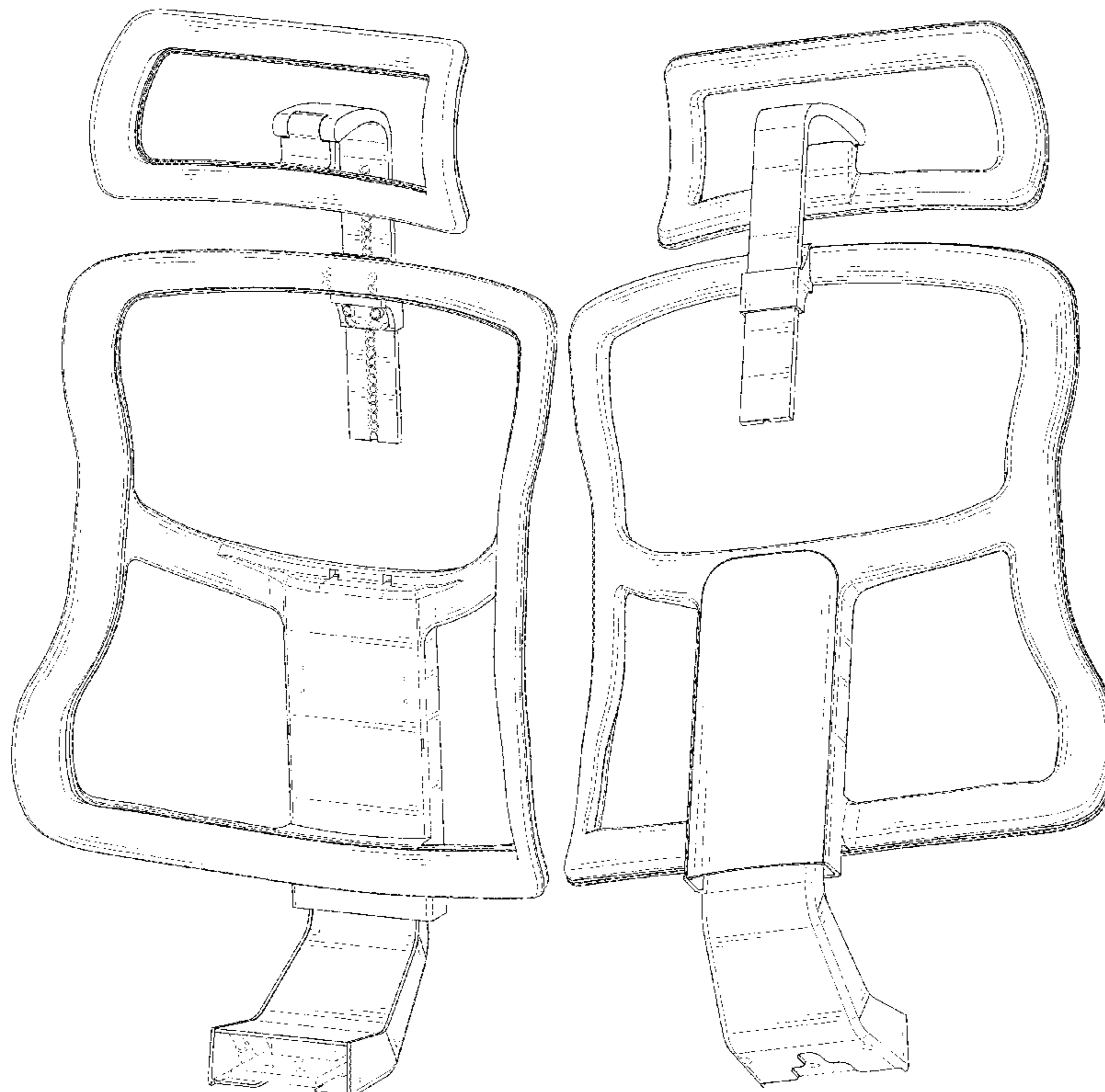

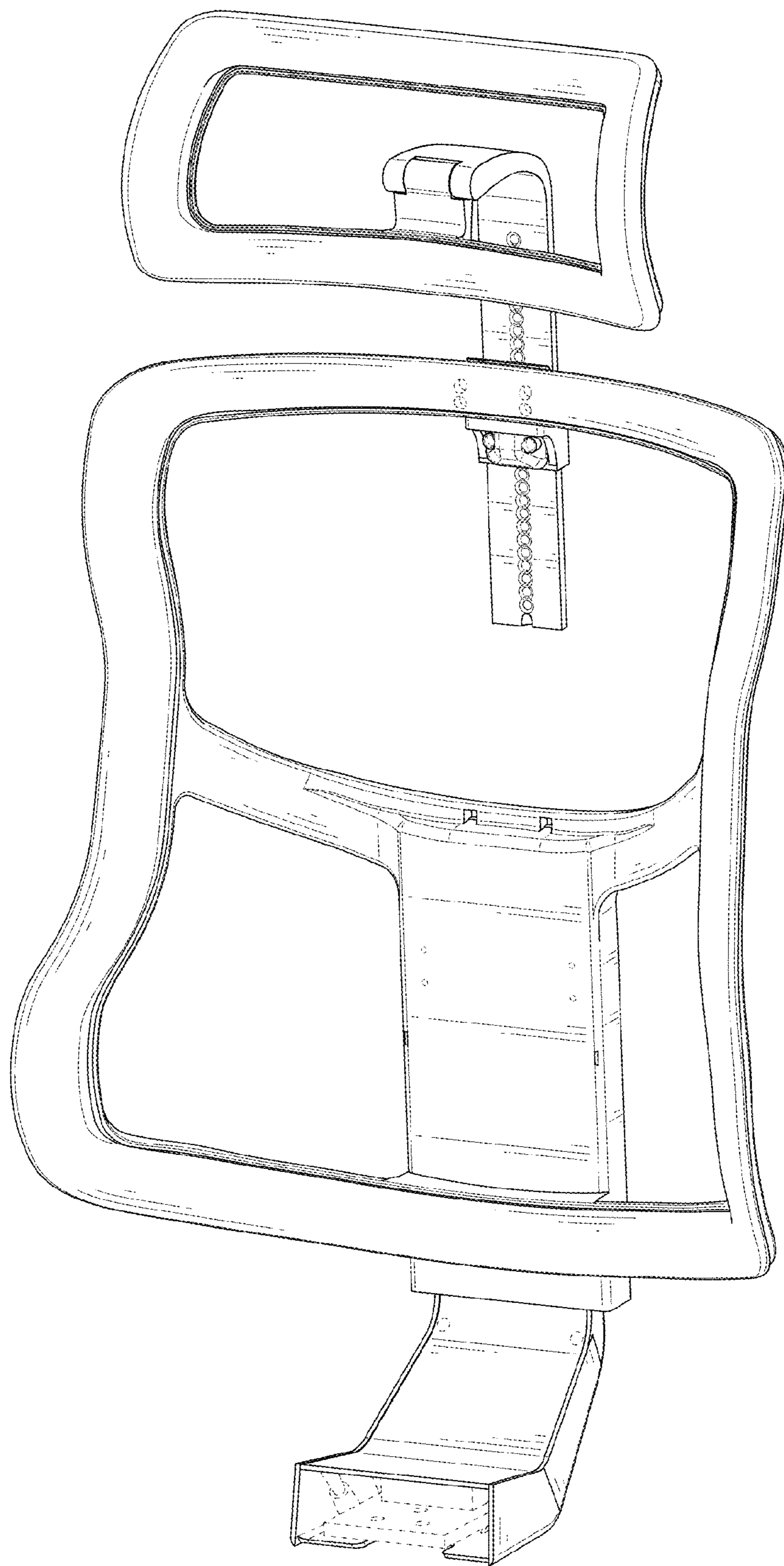

FIG. 1

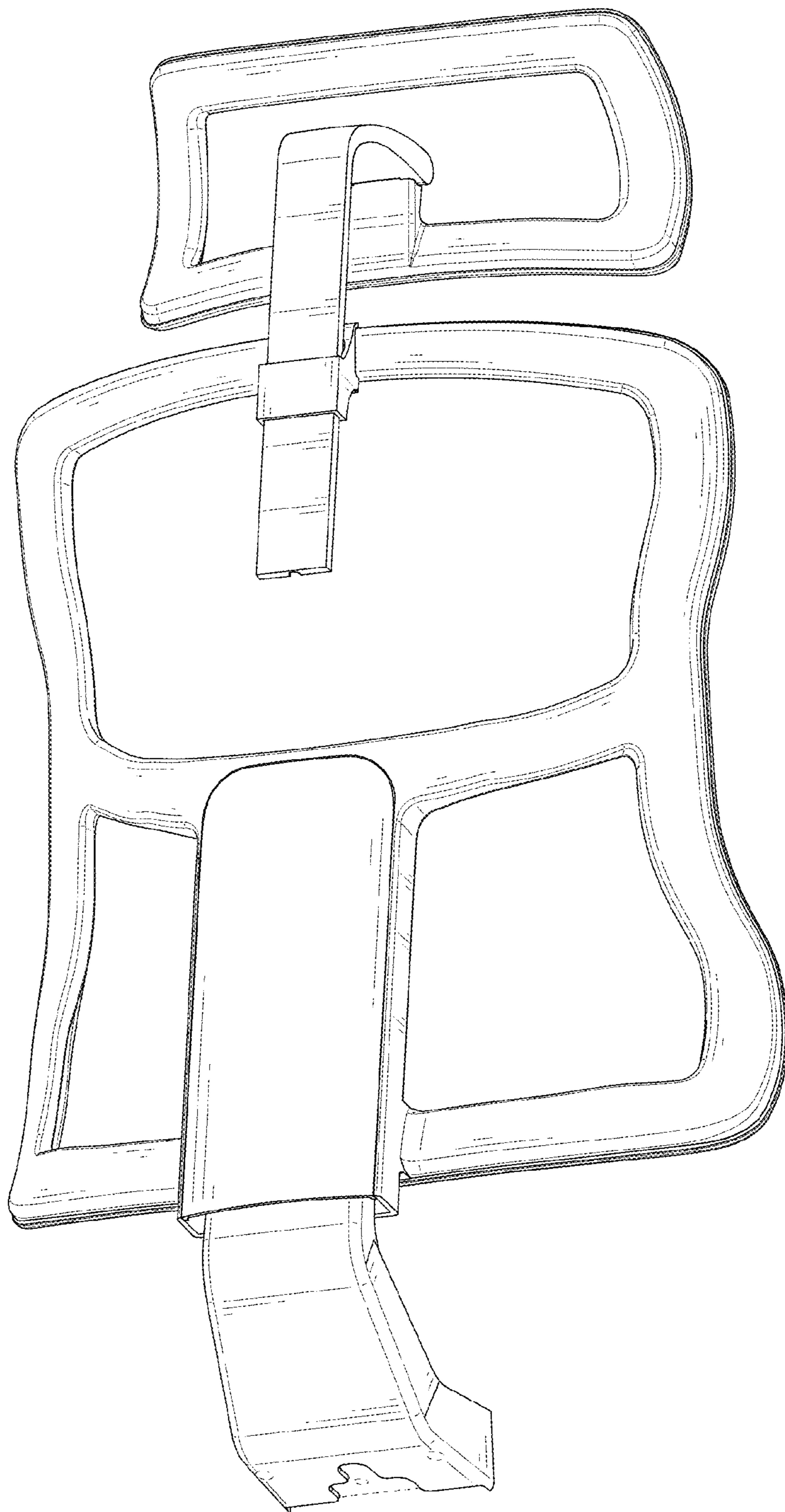

FIG. 2

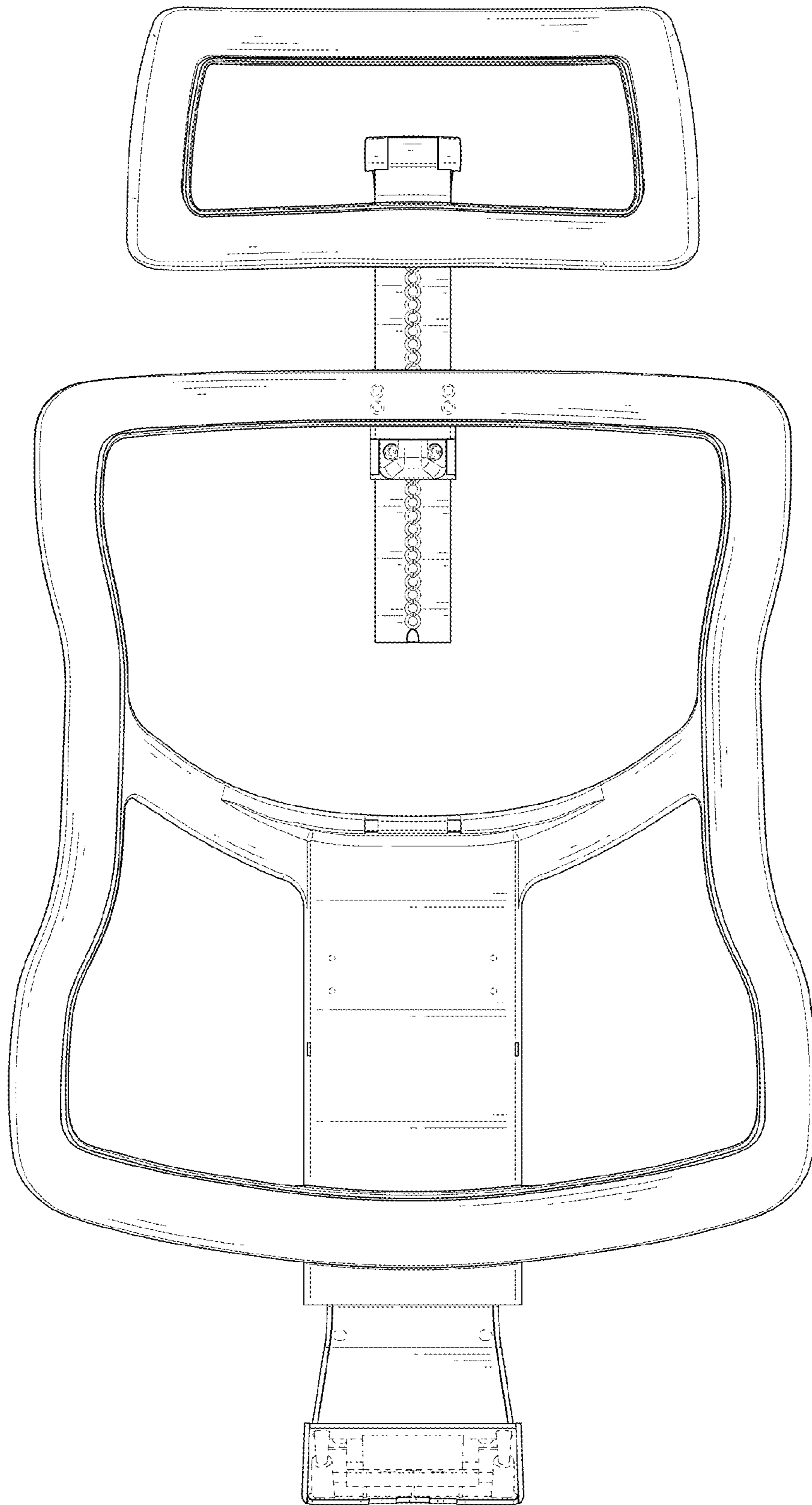

FIG. 3

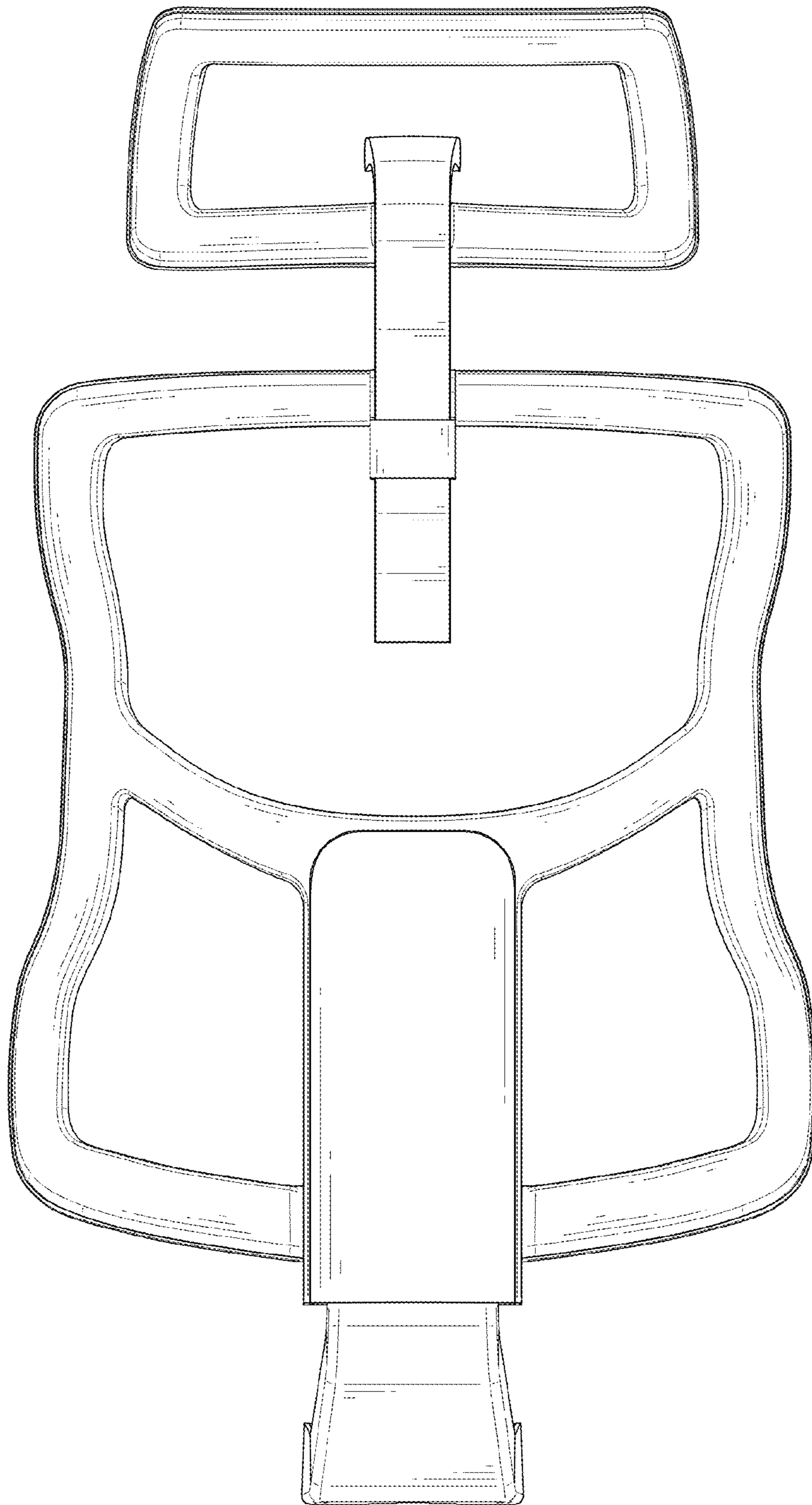

FIG. 4

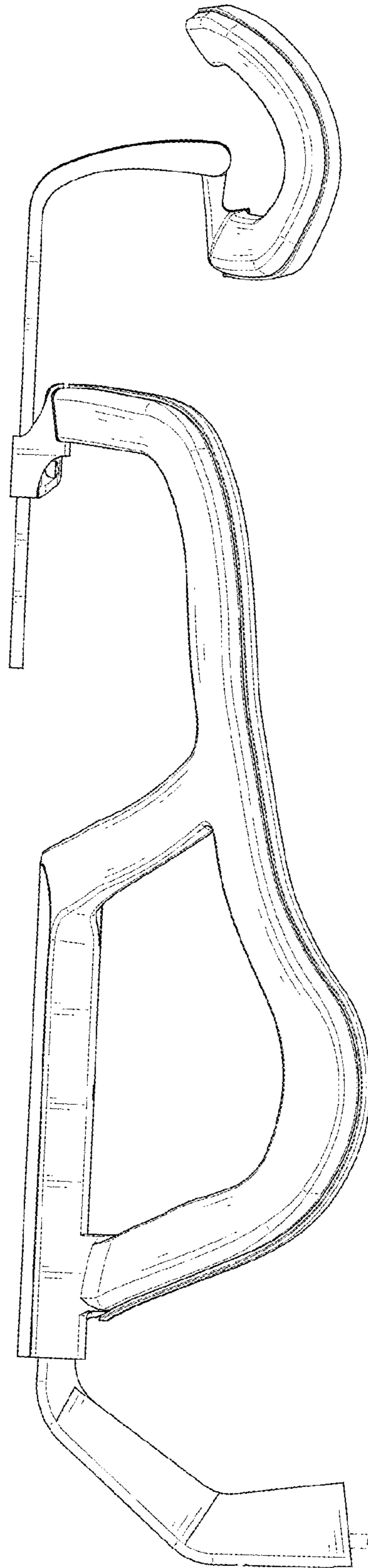

FIG. 5

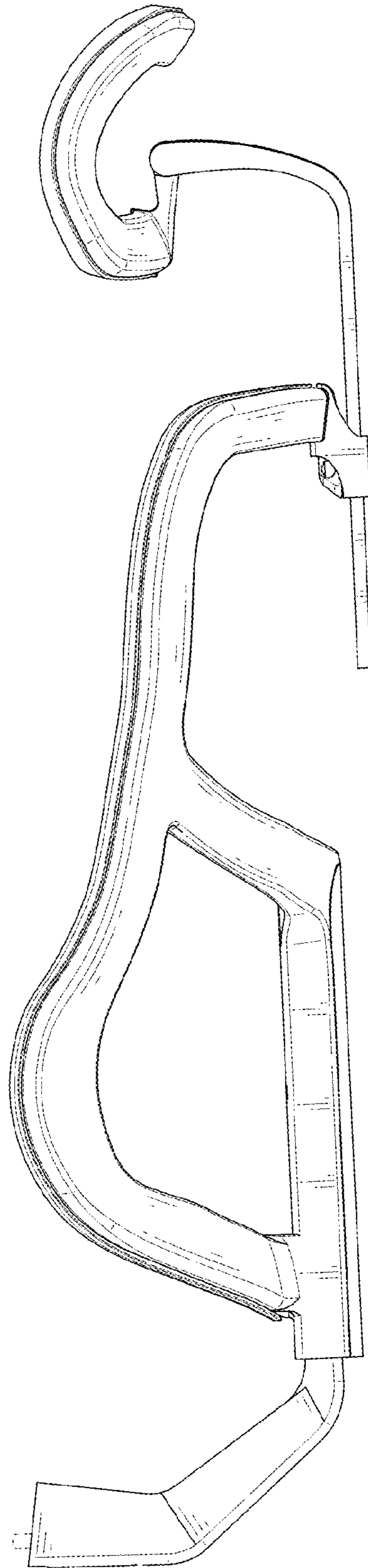

FIG. 6

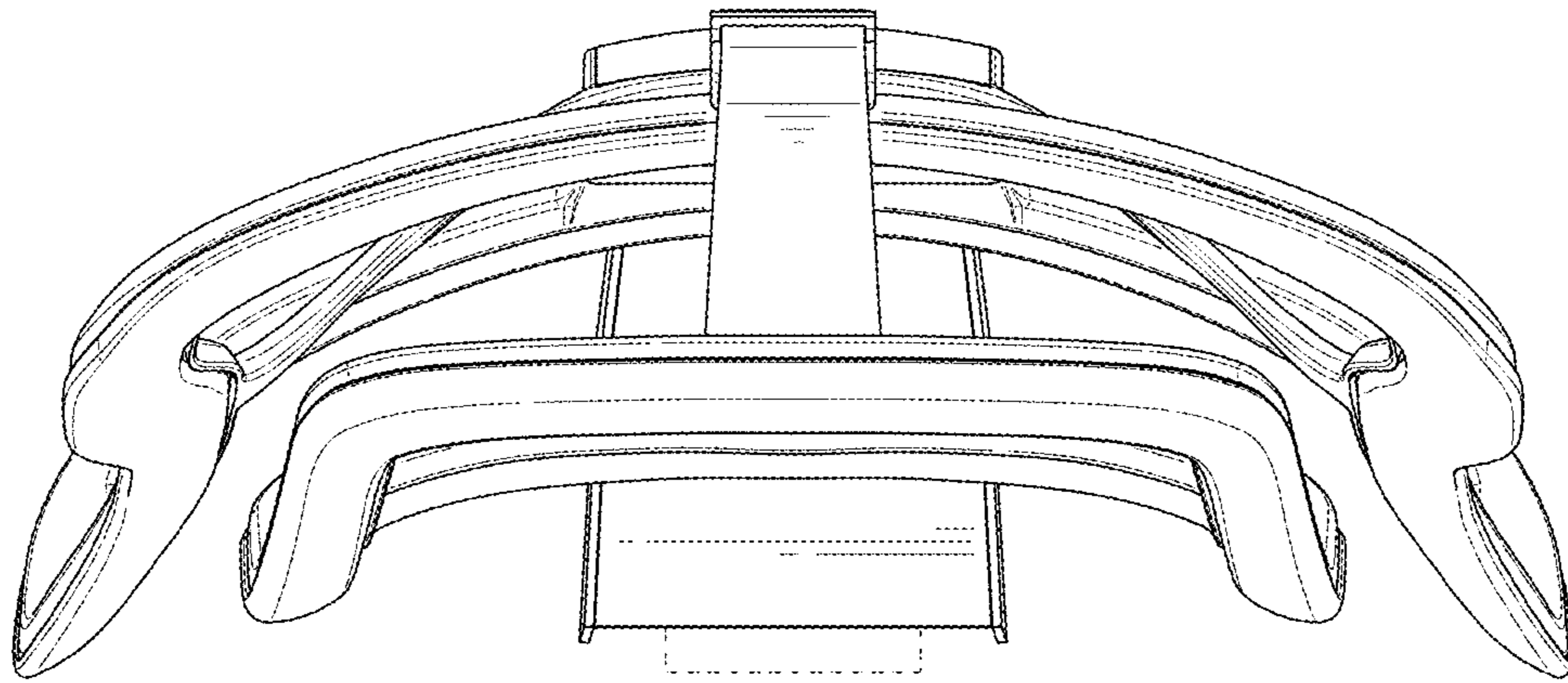

FIG. 7

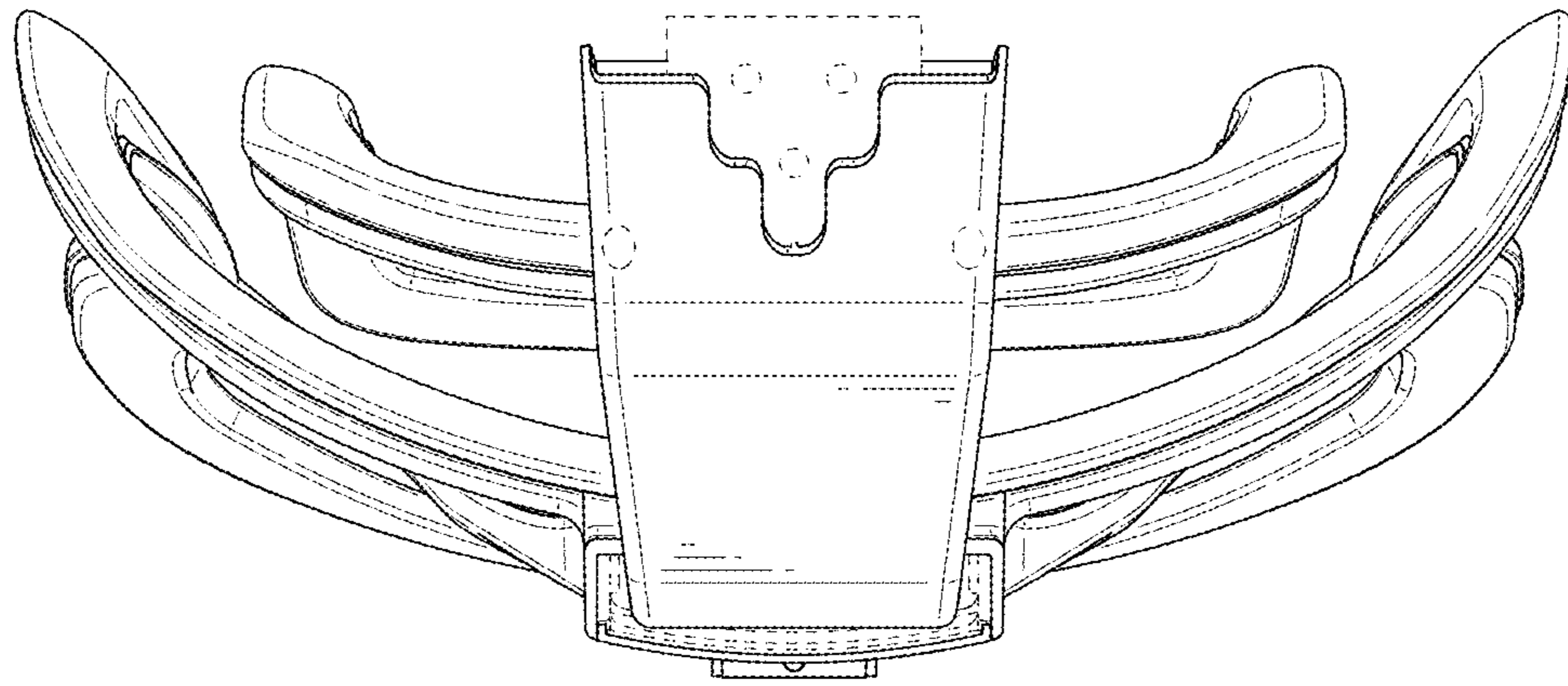

FIG. 8