



US00D927793S

(12) **United States Design Patent**
Valla

(10) **Patent No.:** **US D927,793 S**

(45) **Date of Patent:** **** Aug. 10, 2021**

- (54) **BASEBALL DIAMOND PET BED**
 - (71) Applicant: **Joshua Valla**, Bellevue, NE (US)
 - (72) Inventor: **Joshua Valla**, Bellevue, NE (US)
 - (**) Term: **15 Years**
 - (21) Appl. No.: **29/690,648**
 - (22) Filed: **May 9, 2019**
 - (51) **LOC (13) Cl.** **30-01**
 - (52) **U.S. Cl.**
USPC **D30/118**
 - (58) **Field of Classification Search**
USPC D30/118–119, 158, 160; D21/520;
D6/601, 349, 595–597, 604, 382; D2/719
CPC A01K 1/00; A01K 1/0272; A01K 1/0353;
A01K 1/035
- See application file for complete search history.

(56) **References Cited**

U.S. PATENT DOCUMENTS

D263,543 S *	3/1982	Daugherty	D6/597
D365,486 S *	12/1995	Perry	5/946
D373,148 S *	8/1996	Crow	D21/357
D418,356 S *	1/2000	Davis	D6/610
D420,400 S *	2/2000	Dunagin, III	D21/339
D597,361 S *	8/2009	Smith, Jr.	D6/597
D597,362 S *	8/2009	Smith, Jr.	D6/597
D600,044 S *	9/2009	Lester, Sr.	D6/388
D696,472 S *	12/2013	Popkin	D30/118
D703,877 S *	4/2014	Popkin	D30/118
D728,168 S *	4/2015	Richardson	D30/118

D730,587 S *	5/2015	Pellerin	D30/118
2005/0224000 A1 *	10/2005	Holte	A61F 5/01
				119/28.5
2008/0235869 A1 *	10/2008	Steffes	A47D 7/002
				5/282.1

* cited by examiner

Primary Examiner — Sheryl Lane
Assistant Examiner — Aula Soroush
(74) *Attorney, Agent, or Firm* — Baird Holm LLP

(57) **CLAIM**

The ornamental design for a baseball diamond pet bed, as shown and described.

DESCRIPTION

FIG. 1 is a perspective view of a baseball diamond pet bed showing my new design.
 FIG. 2 is a top view of the baseball diamond pet bed.
 FIG. 3 is a front elevation view of the baseball diamond pet bed.
 FIG. 4 is a right side elevation view of the baseball diamond pet bed.
 FIG. 5 is a left side elevation view of the baseball diamond pet bed.
 FIG. 6 is a rear elevation view of the baseball diamond pet bed.
 FIG. 7 is a bottom view of the baseball diamond pet bed; and,
 FIG. 8 is another perspective view of the baseball diamond pet bed.
 The broken lines shown in FIG. 8 show a logo that is illustrative of environmental structure and form no part of the claimed design.

1 Claim, 4 Drawing Sheets

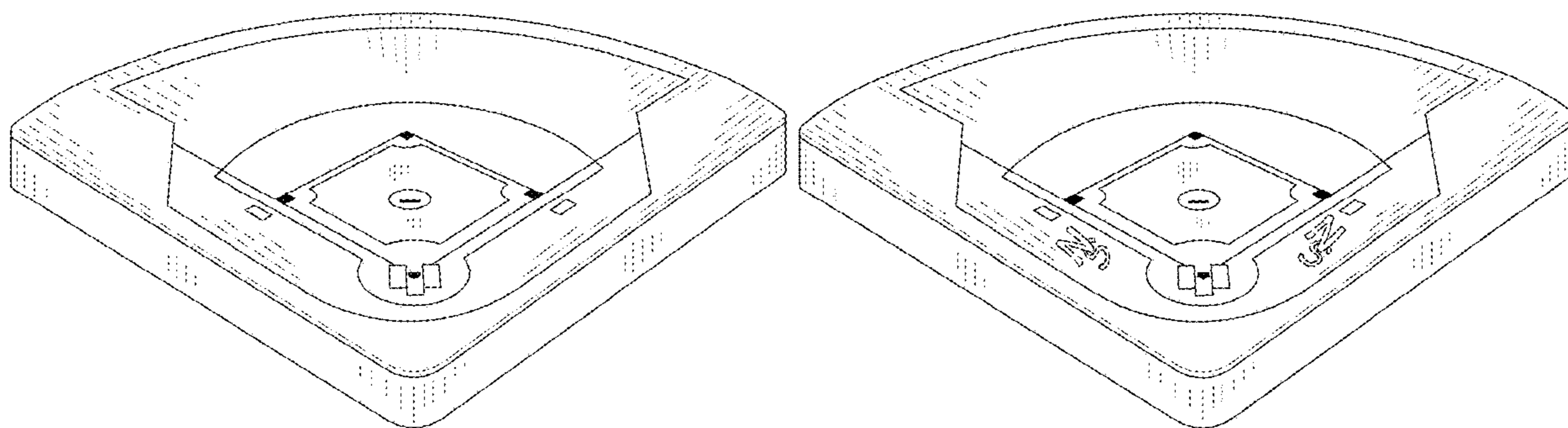

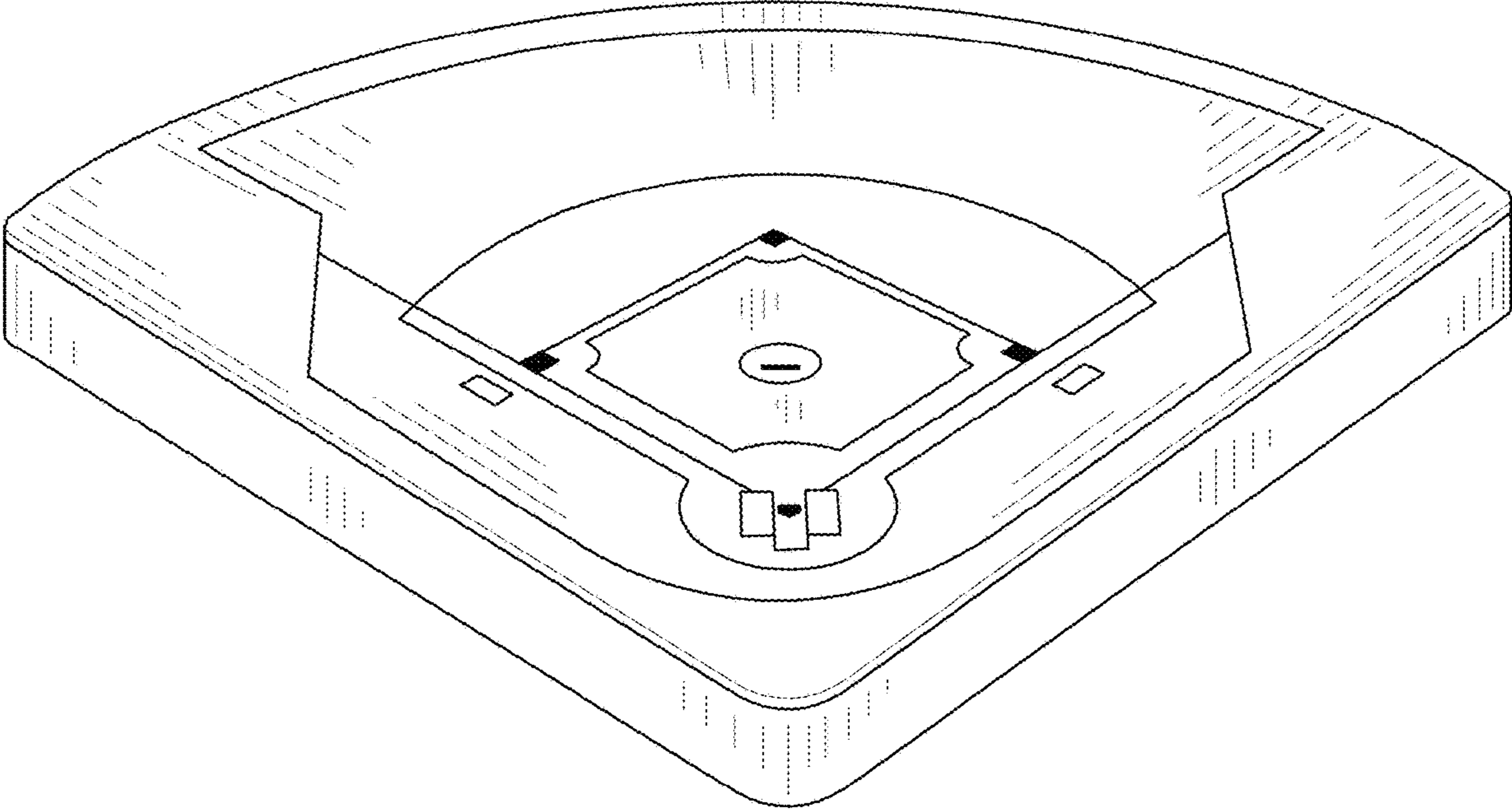

FIG. 1

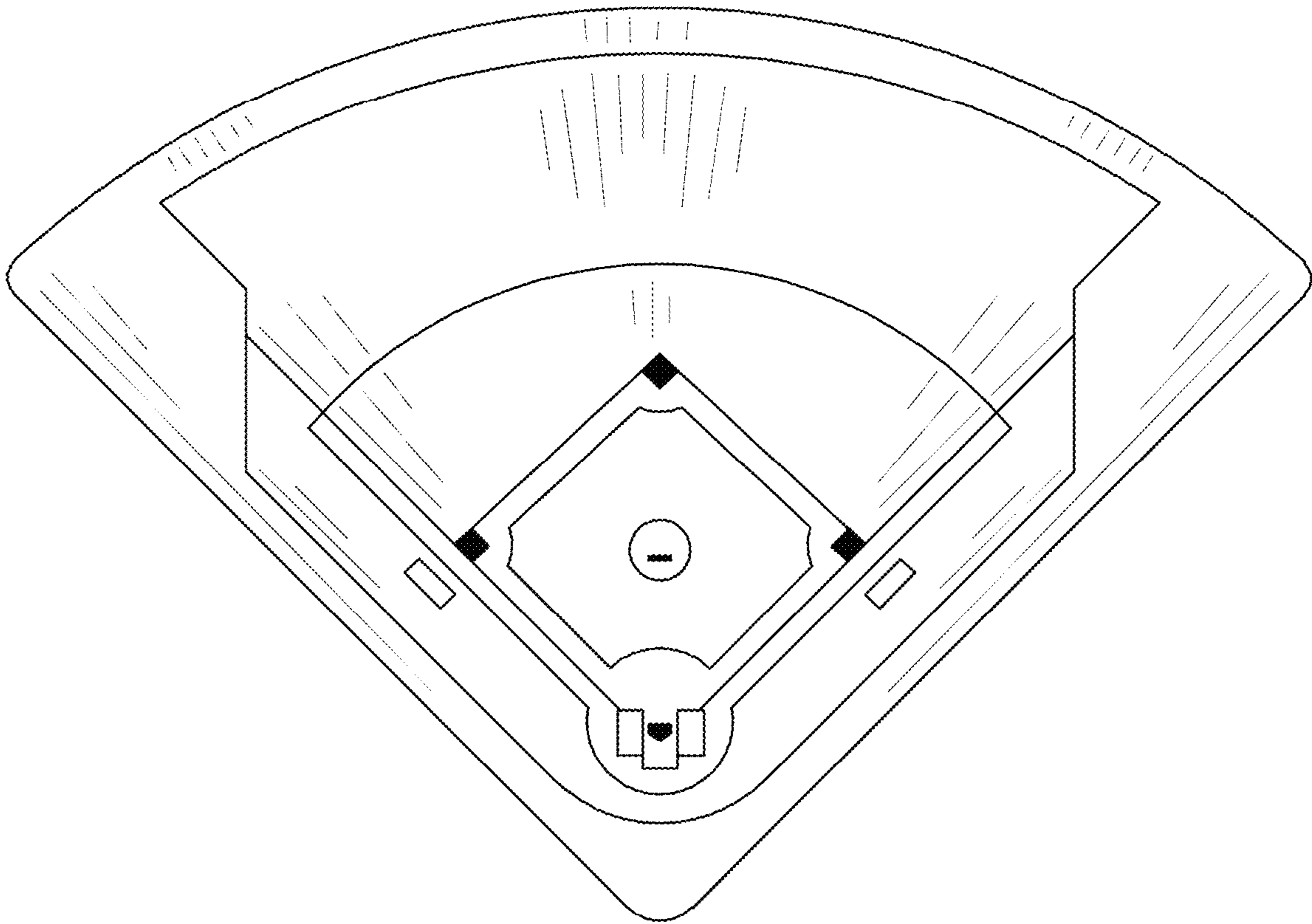

FIG. 2

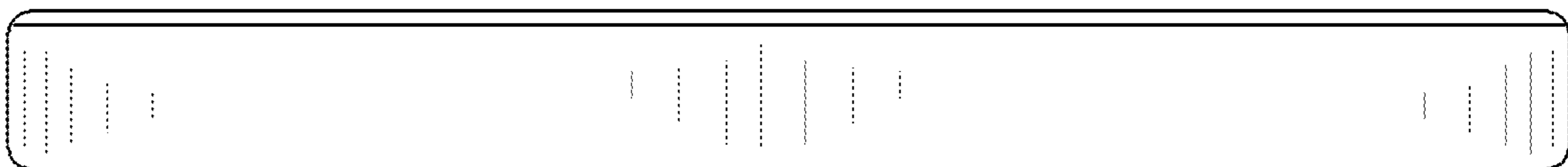

FIG. 3

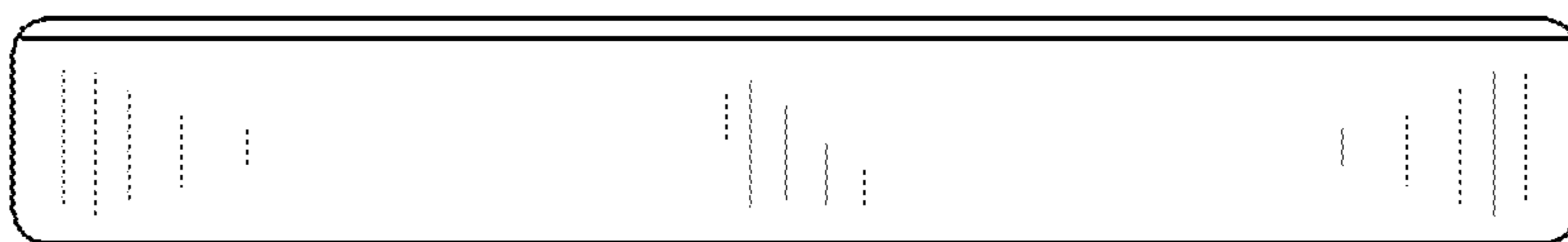

FIG. 4

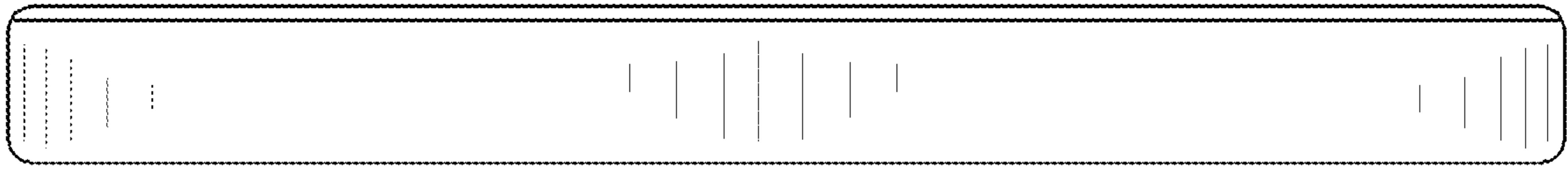

FIG. 5

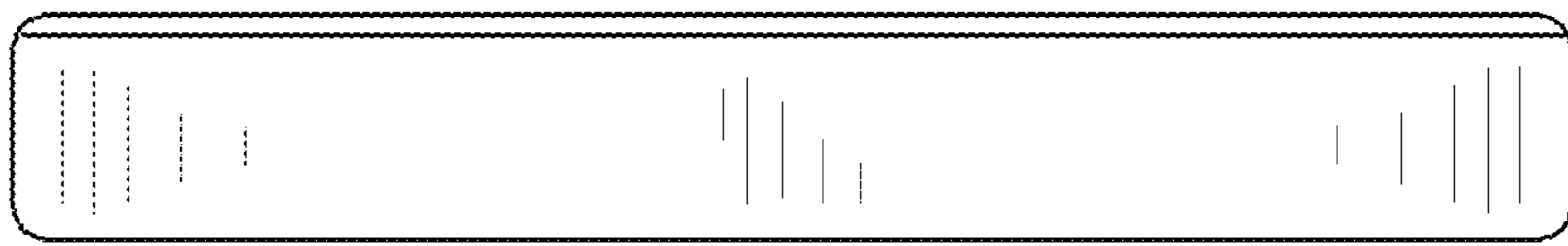

FIG. 6

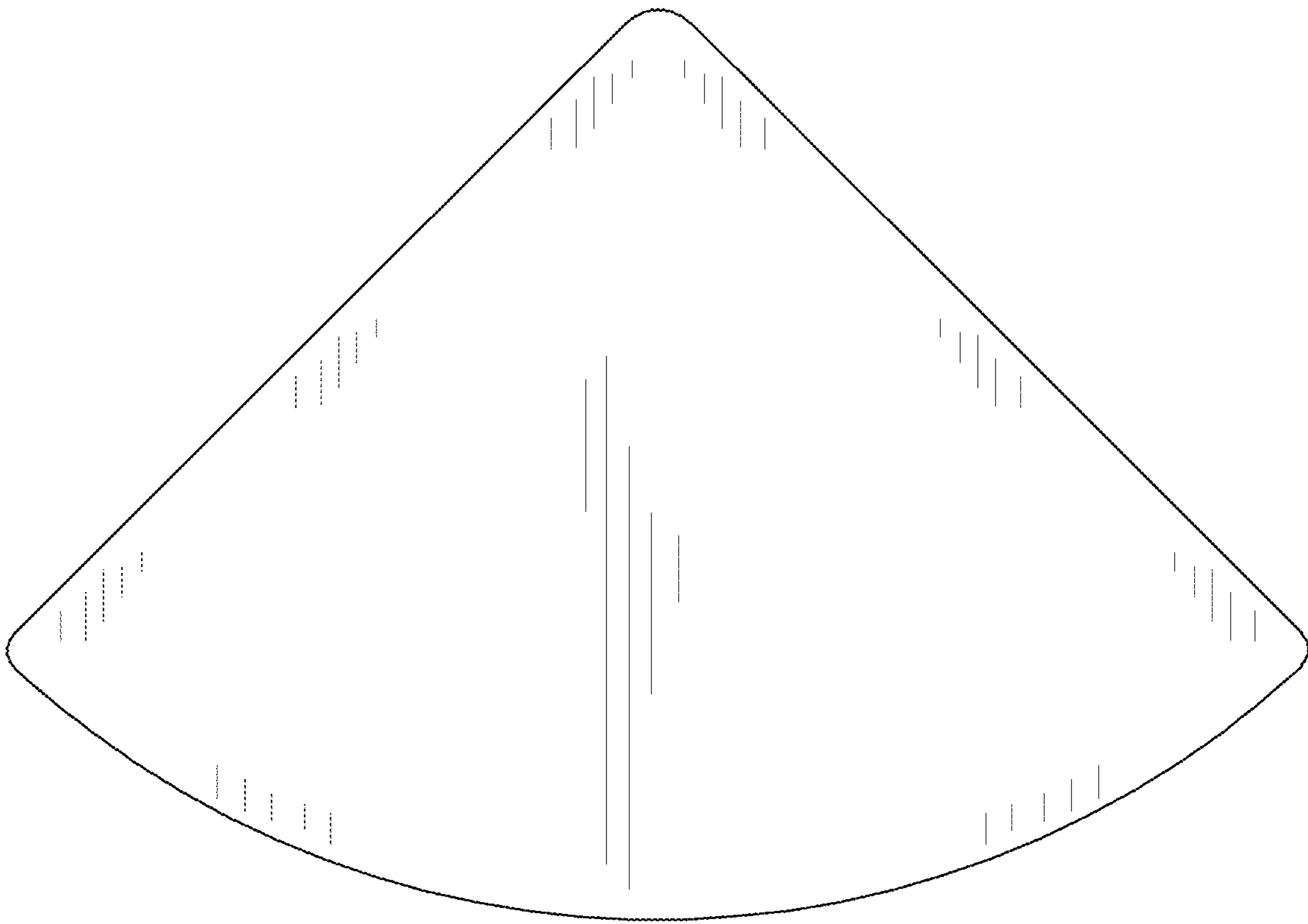

FIG. 7

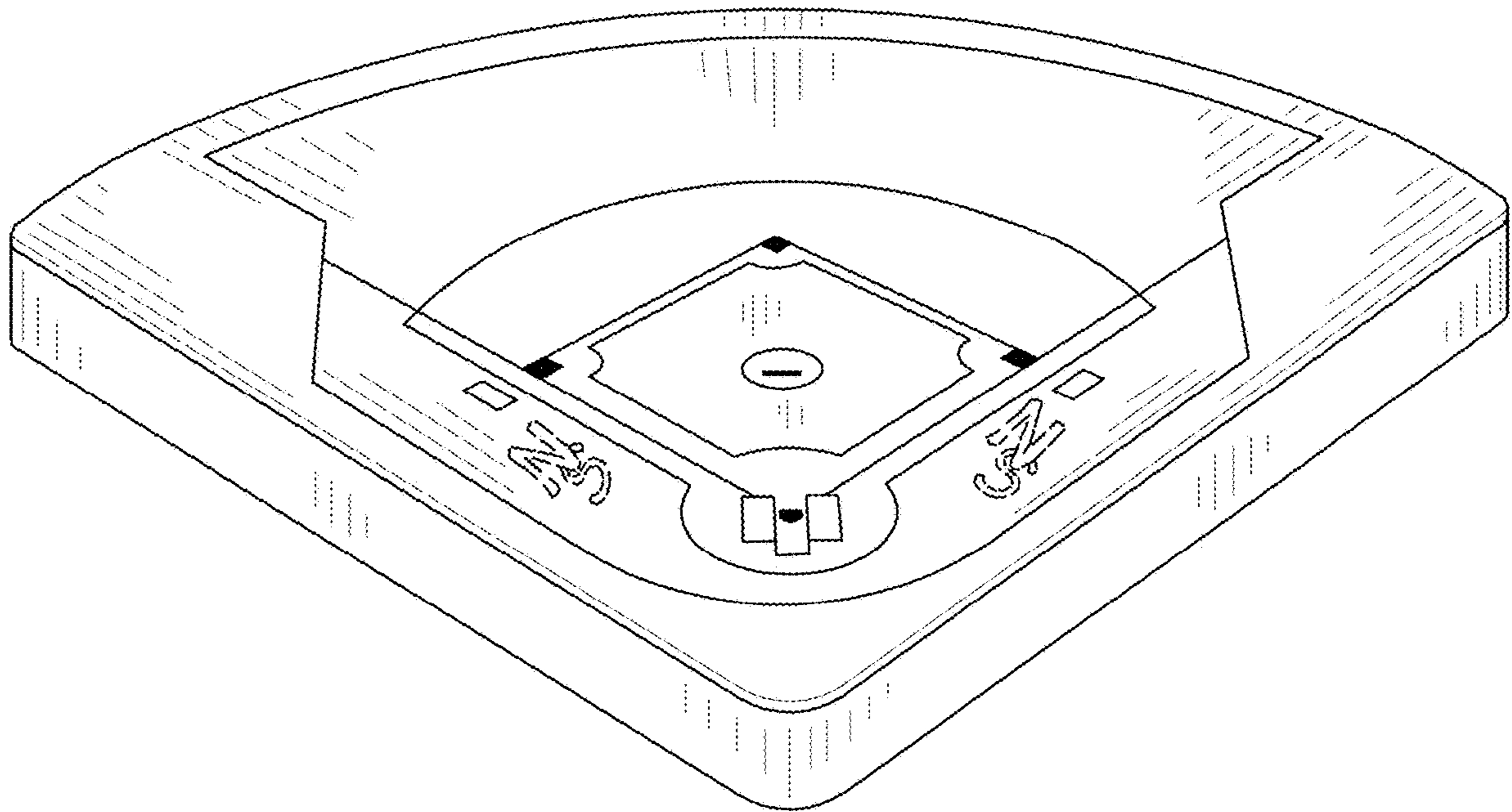

FIG. 8