



US00D927767S

(12) **United States Design Patent**
Zheng et al.

(10) **Patent No.:** **US D927,767 S**

(45) **Date of Patent:** **** Aug. 10, 2021**

(54) **STAR MOON LIGHT**

(71) Applicant: **Shenzhen Skoe Technology Co., Ltd.**,
Shenzhen (CN)

(72) Inventors: **Caijian Zheng**, Shenzhen (CN);
Wenzhen Ouyang, Shenzhen (CN)

(**) Term: **15 Years**

(21) Appl. No.: **29/747,473**

(22) Filed: **Aug. 24, 2020**

(51) **LOC (13) Cl.** **26-03**

(52) **U.S. Cl.**
USPC **D26/110**

(58) **Field of Classification Search**
USPC D26/93, 104, 106, 110, 112
CPC F21Y 2101/02; F21S 10/00; F21V 21/30;
F21V 14/02; F21V 21/00
See application file for complete search history.

(56) **References Cited**

U.S. PATENT DOCUMENTS

D602,621 S 10/2009 Kay
D607,600 S 1/2010 Keith
D840,582 S * 2/2019 Liu D26/104

D861,966 S * 10/2019 Wang D26/110
D866,014 S 11/2019 Zhang
D901,747 S * 11/2020 Lin D26/106
D907,281 S * 1/2021 Wu D26/104
D914,958 S * 3/2021 Zheng D26/110

* cited by examiner

Primary Examiner — Brian N. Vinson

(57) **CLAIM**

The ornamental design for a star moon light, as shown and described.

DESCRIPTION

FIG. 1 is a first perspective view of a star moon light showing my new design;
FIG. 2 is a second perspective view thereof;
FIG. 3 is a front view thereof;
FIG. 4 is a back view thereof;
FIG. 5 is a left side view thereof;
FIG. 6 is a right side view thereof;
FIG. 7 is a top view thereof; and,
FIG. 8 is a bottom view thereof.
The broken lines shown in the drawings depict portions of the star moon light in which the design is embodied that form no part of the claimed design.

1 Claim, 8 Drawing Sheets

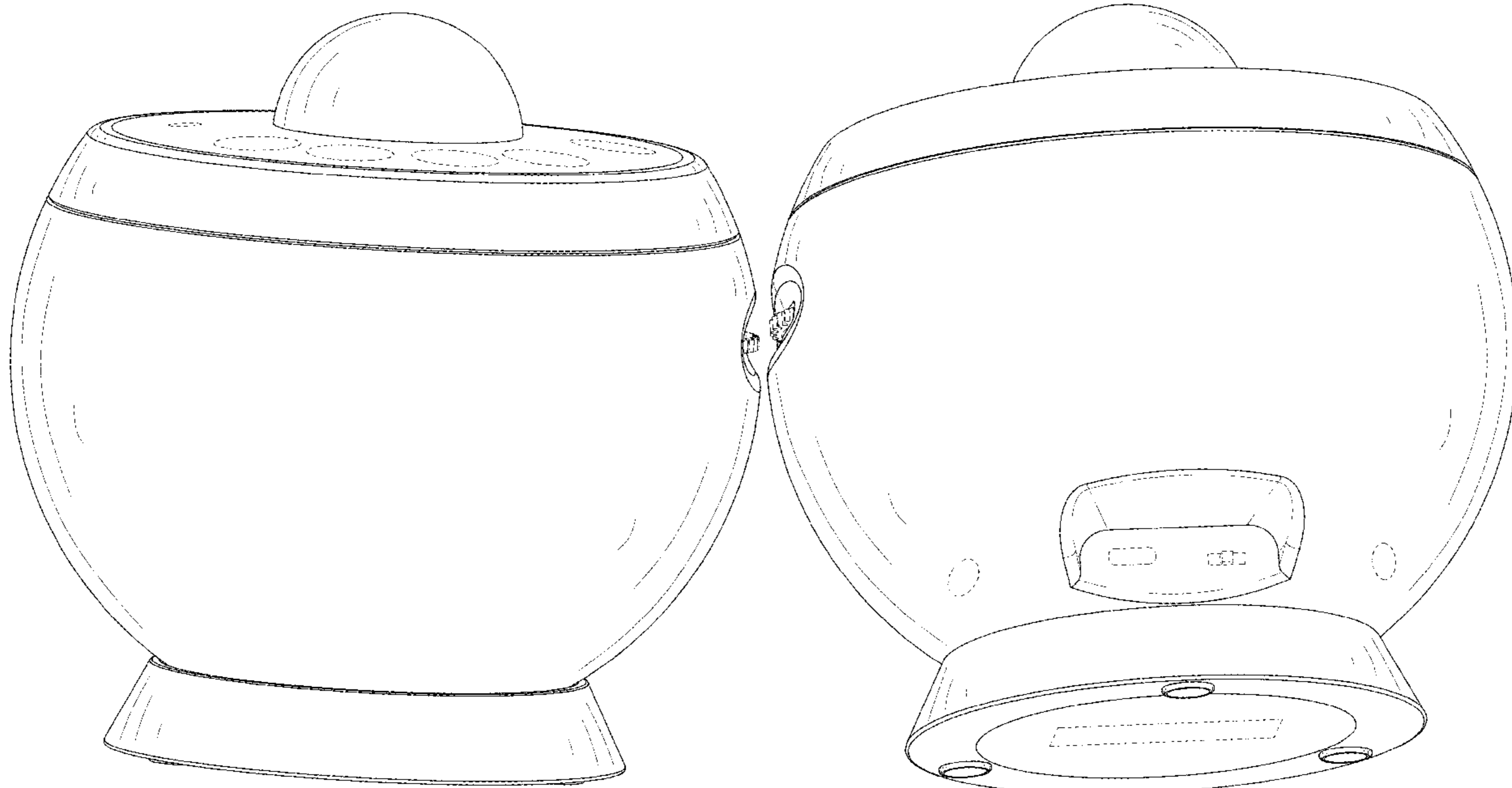

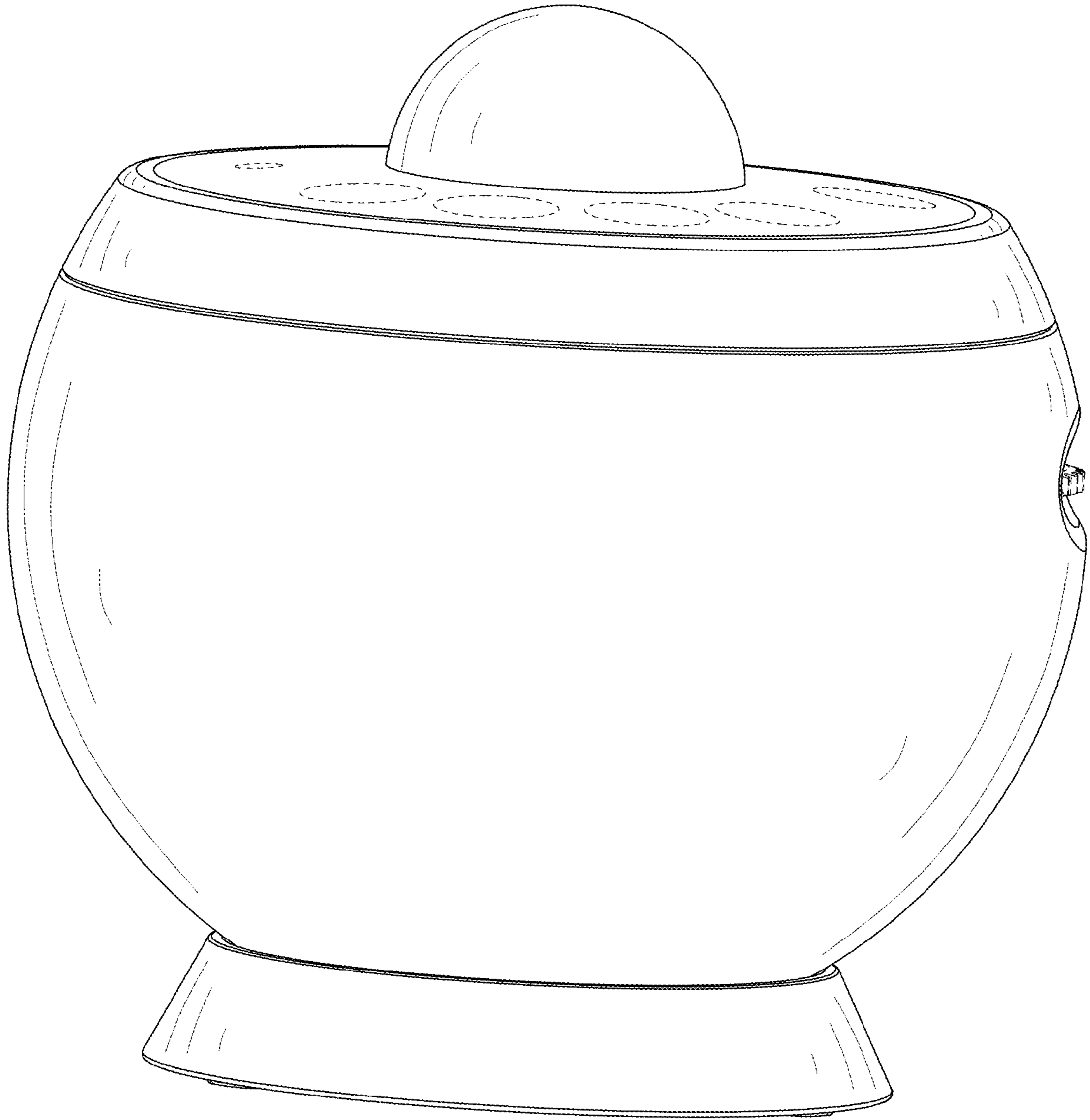

FIG. 1

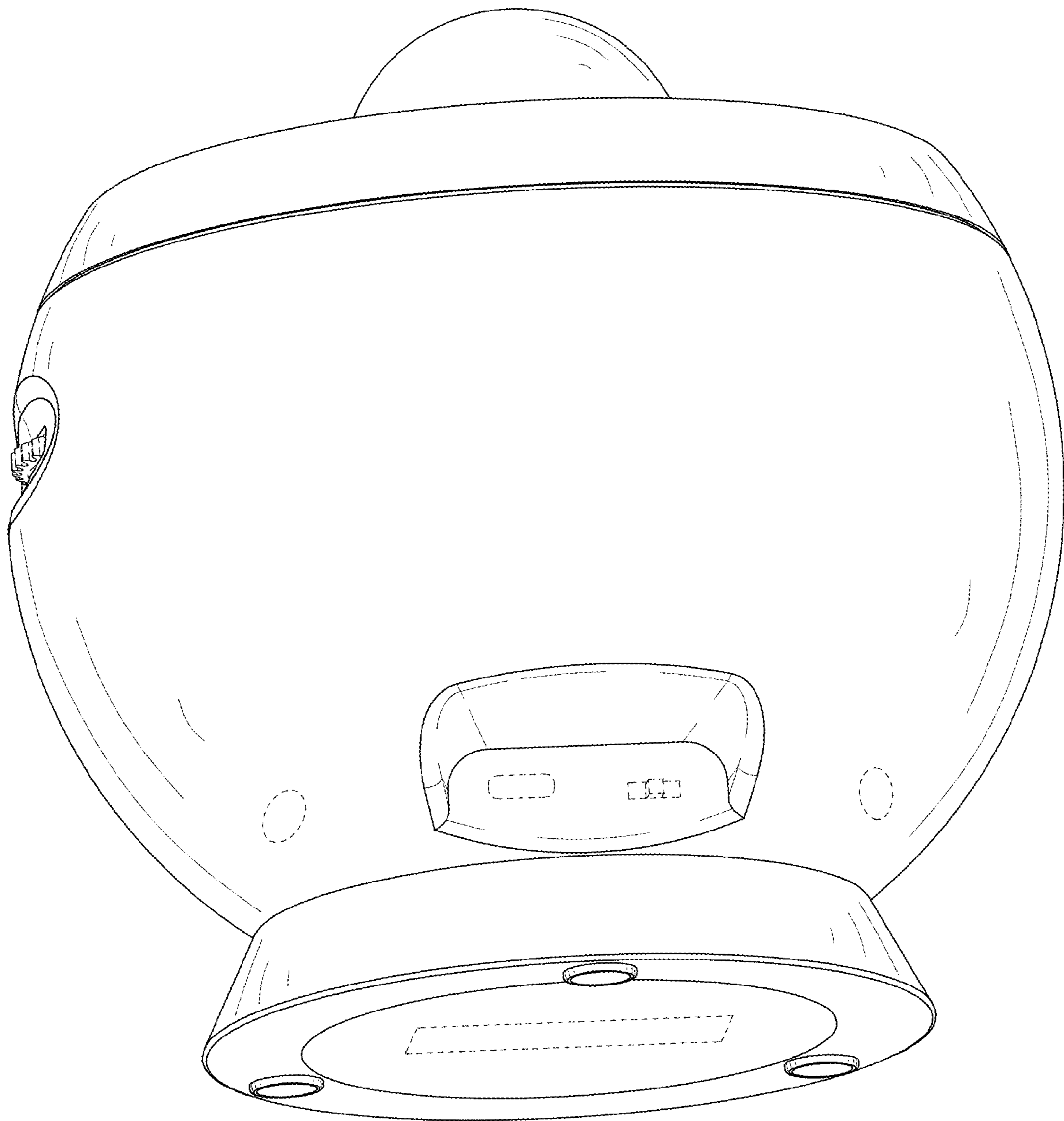

FIG. 2



FIG. 3

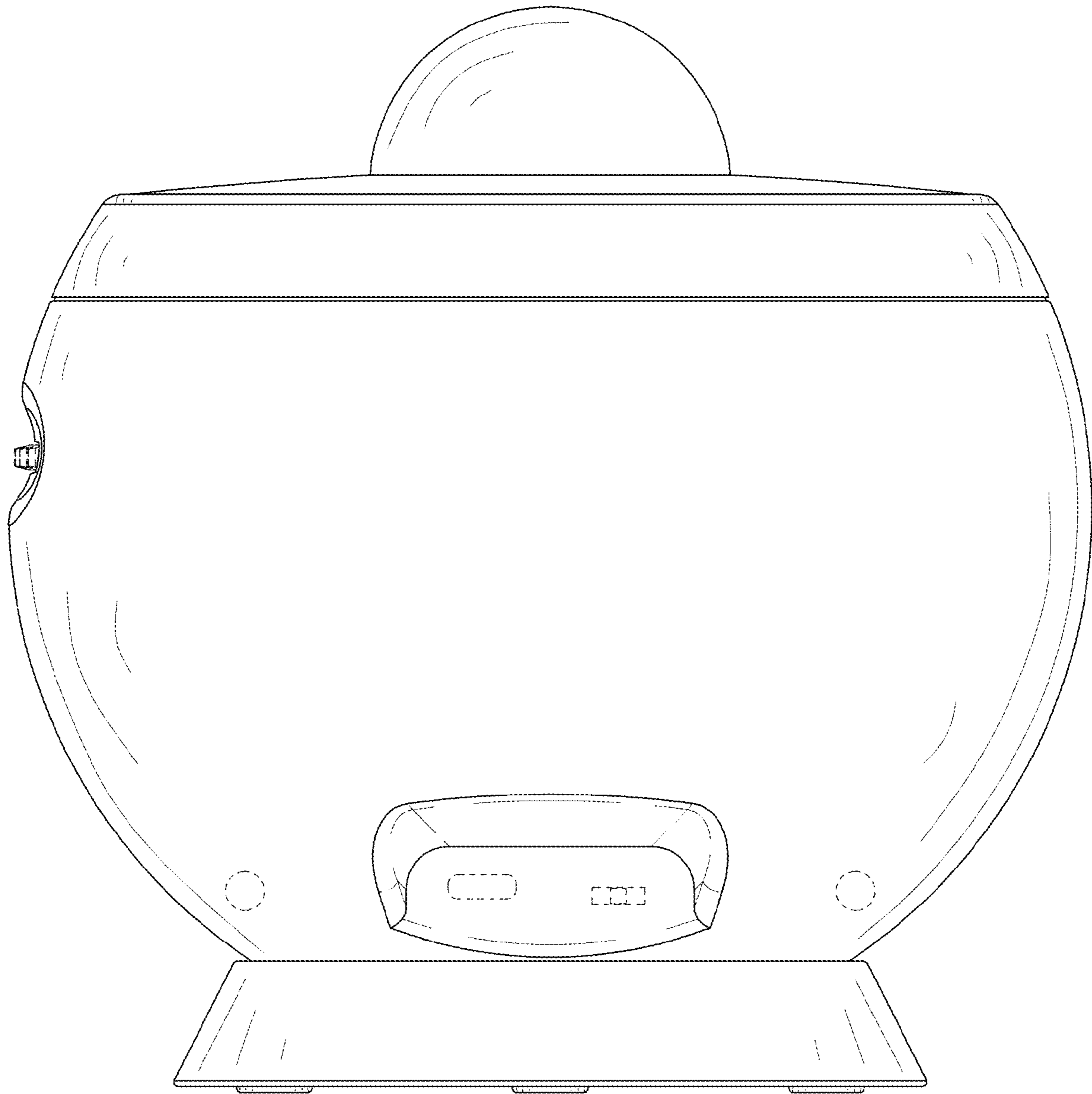

FIG. 4

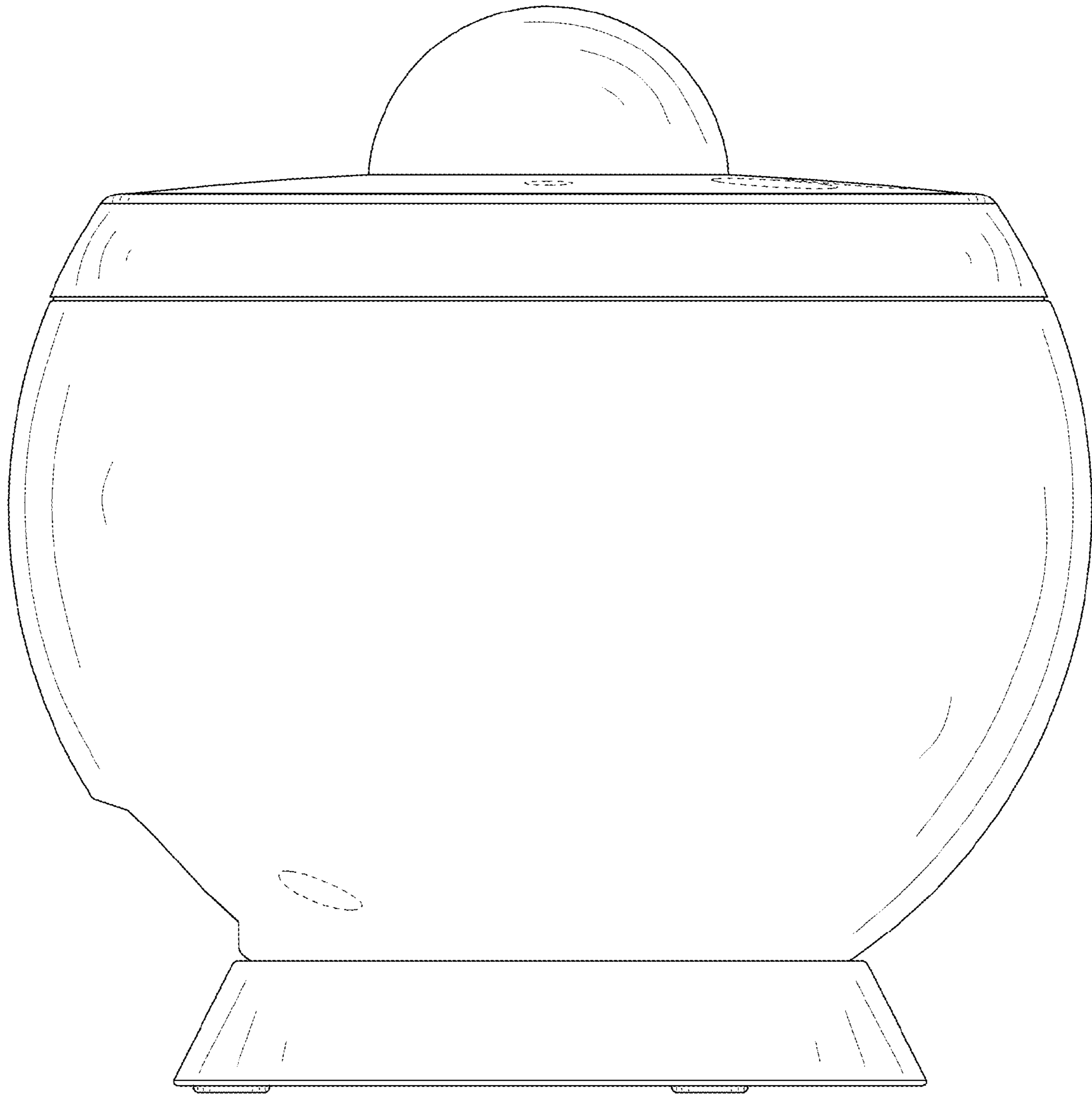

FIG. 5



FIG. 6

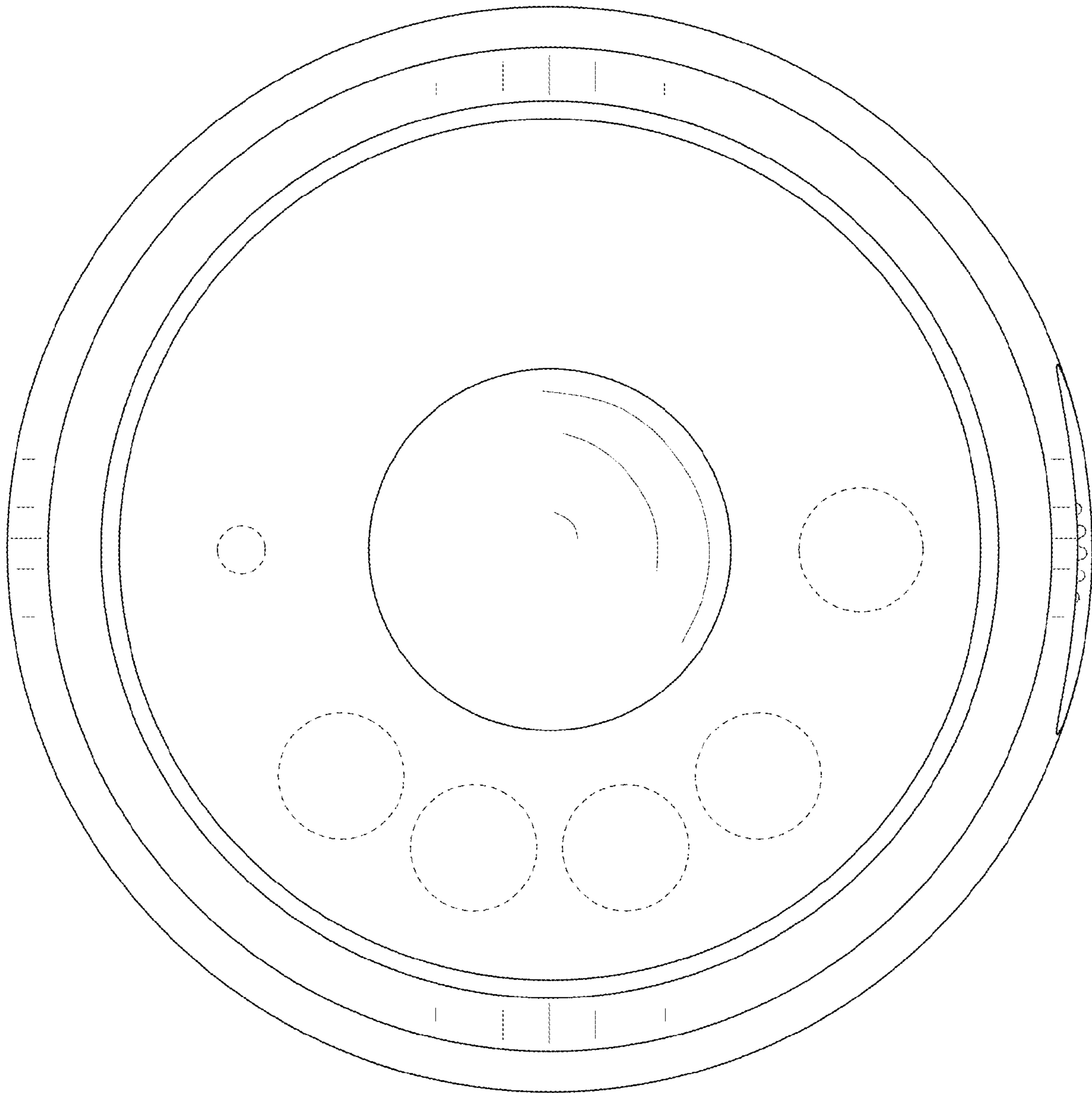

FIG. 7

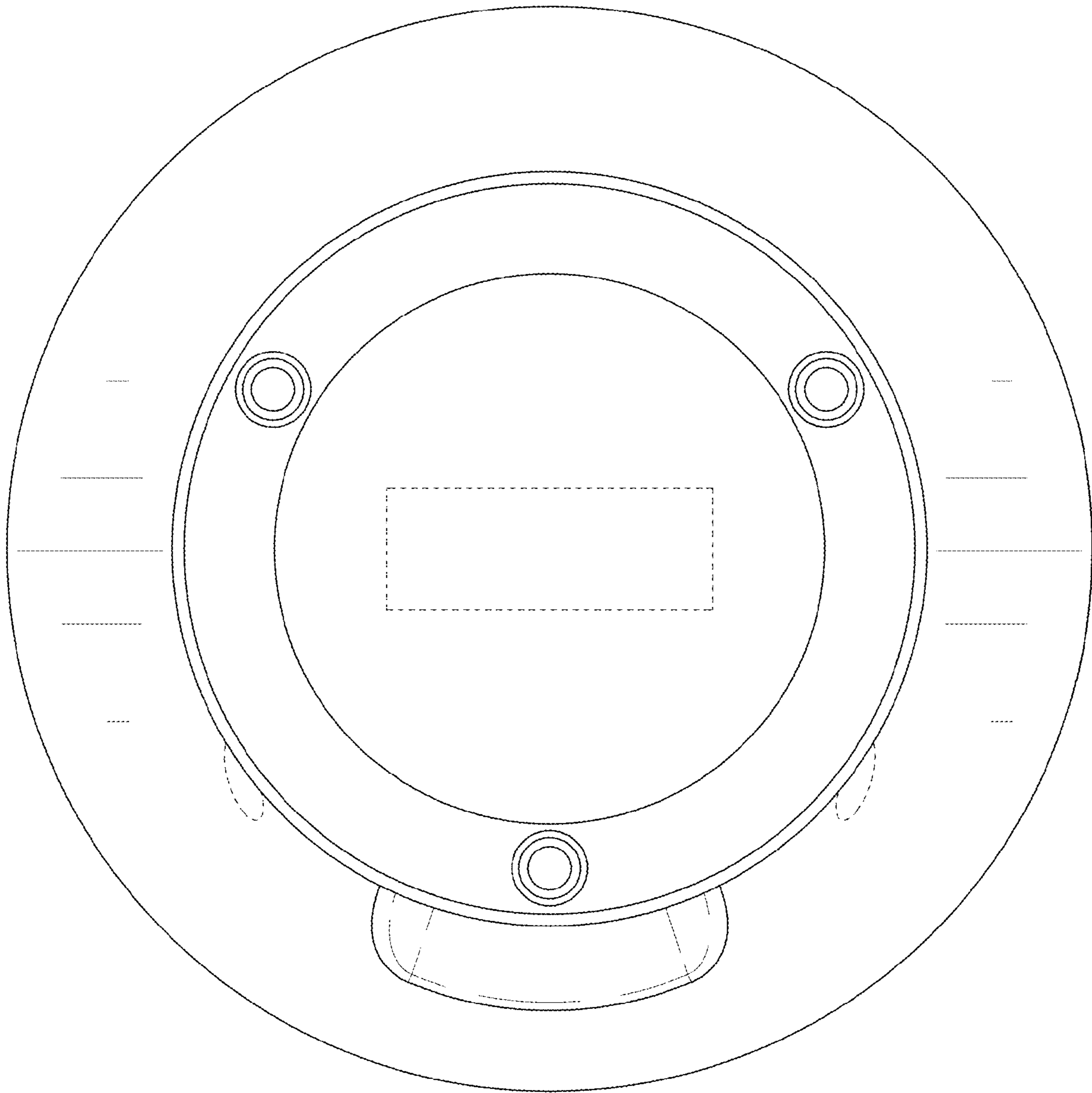

FIG. 8