



US00D927756S

(12) **United States Design Patent** (10) **Patent No.:** **US D927,756 S**
Liang (45) **Date of Patent:** **** Aug. 10, 2021**

(54) **SOLAR WALL LIGHT**
(71) Applicant: **Qinghui Liang**, Fujian (CN)
(72) Inventor: **Qinghui Liang**, Fujian (CN)
(**) Term: **15 Years**
(21) Appl. No.: **29/686,380**
(22) Filed: **Apr. 4, 2019**
(51) **LOC (13) Cl.** **26-05**
(52) **U.S. Cl.**
USPC **D26/72**
(58) **Field of Classification Search**
USPC D10/111-115; D26/24, 51, 60, 61, 63,
D26/67, 72, 75, 76, 78, 80, 85, 86, 87,
D26/88, 89, 113, 118, 121, 135
CPC F21S 8/00; F21S 8/02; F21S 8/03; F21S
8/04; F21S 8/033; F21S 8/08; F21S 8/36;
F21S 8/037; F21S 8/043; F21S 9/03;
F21S 9/022; F21S 9/037
See application file for complete search history.

D861,526 S * 10/2019 Wang 10/106.6
D861,947 S * 10/2019 Ma D26/72
2013/0271979 A1* 10/2013 Pearson F21S 2/005
362/235

OTHER PUBLICATIONS

John Timberland® Bronze Grid 10" High Outdoor Wall Light
(available online) Retrieved from the internet Mar. 30, 2021 from
URL:https://www.lampsplus.com/products/john-timberland-bronze-
grid-10-inch-high-outdoor-wall-light_98999.html.*

* cited by examiner

Primary Examiner — Kevin K Rudzinski
Assistant Examiner — Richard Kearney

(57) **CLAIM**

The ornamental design for a solar wall light, as shown and
described.

(56) **References Cited**

U.S. PATENT DOCUMENTS

D215,175 S * 9/1969 Osborne D26/63
D363,250 S * 10/1995 Miyatake 10/114.1
D434,515 S * 11/2000 McNamara D26/63
D563,020 S * 2/2008 Campagna D26/72
D582,089 S * 12/2008 Gotz-Schafer D26/86
D659,280 S * 5/2012 Guercio 26/118
D668,370 S * 10/2012 Guercio D26/71
D672,908 S * 12/2012 Wilcox F21V 23/009
26/118
9,322,533 B1 * 4/2016 Pearson F21V 21/02
D782,092 S * 3/2017 Heiner D26/63

DESCRIPTION

FIG. 1 is a front elevational view of a solar wall light
showing my new design;
FIG. 2 is a rear elevational view thereof;
FIG. 3 is a left side view thereof;
FIG. 4 is a right side view thereof;
FIG. 5 is a top plan view thereof;
FIG. 6 is a bottom plan view thereof;
FIG. 7 is a perspective view thereof; and,
FIG. 8 is another perspective view thereof.

1 Claim, 8 Drawing Sheets

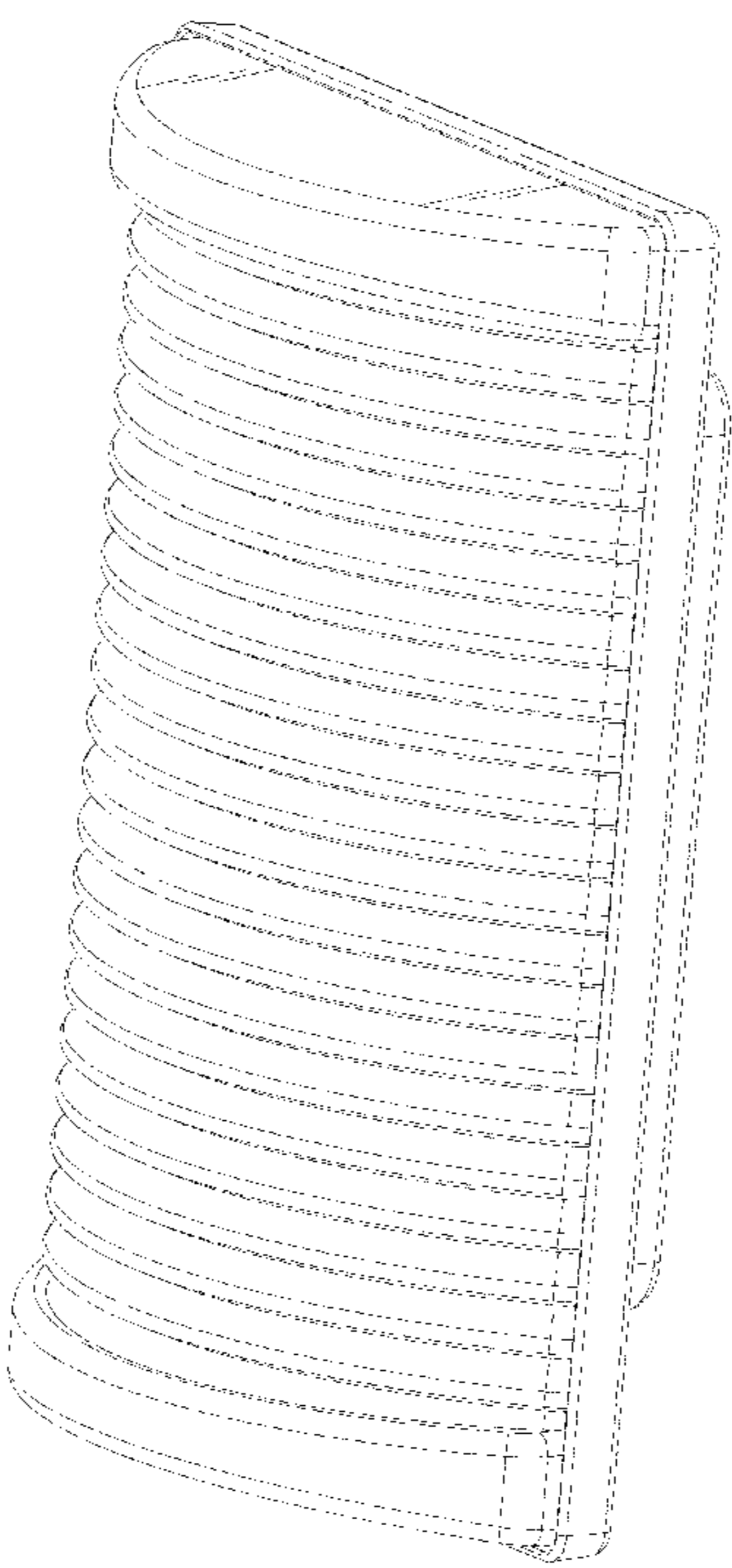

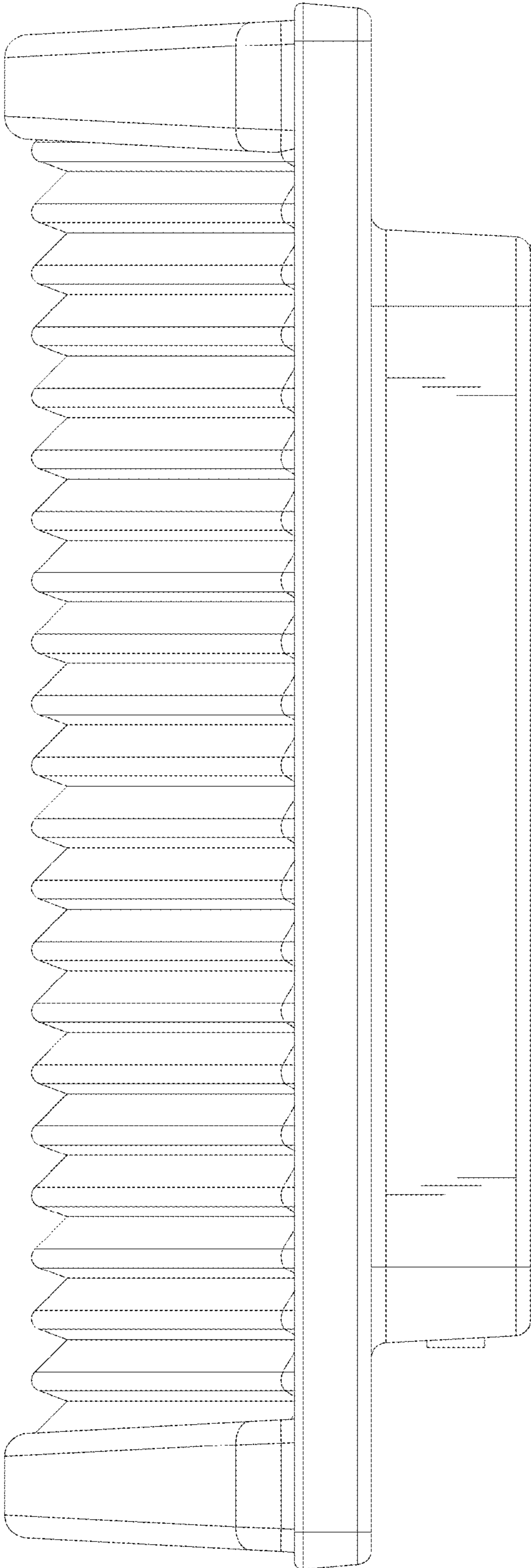

Fig. 1

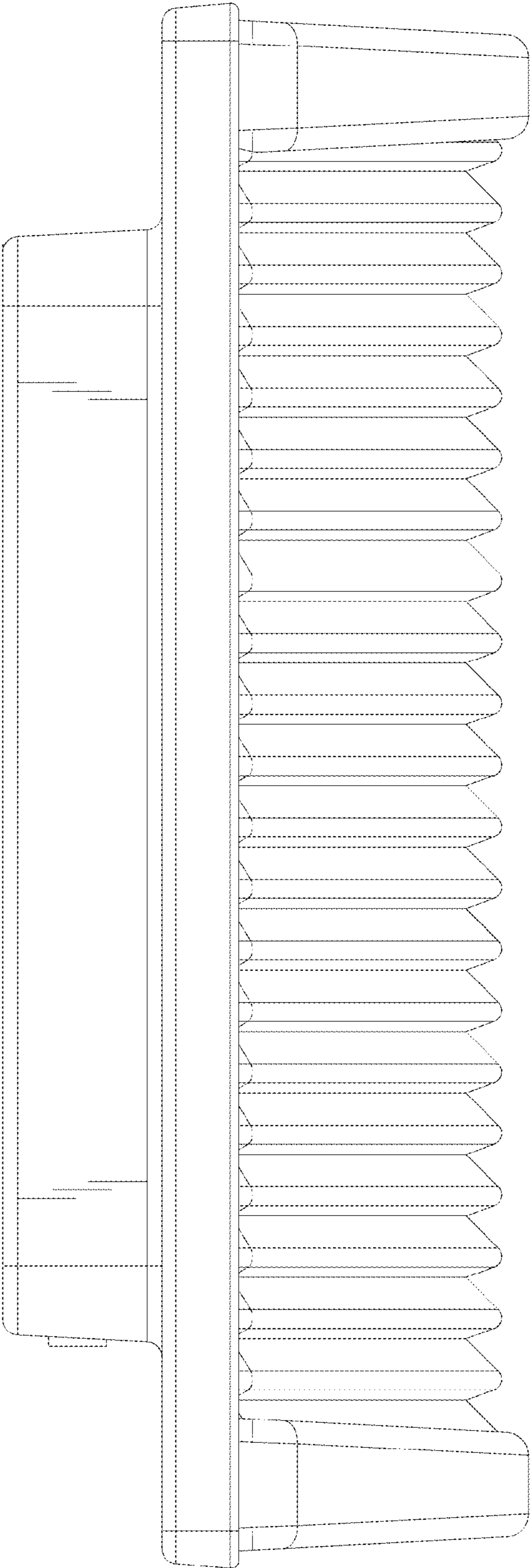

Fig. 2

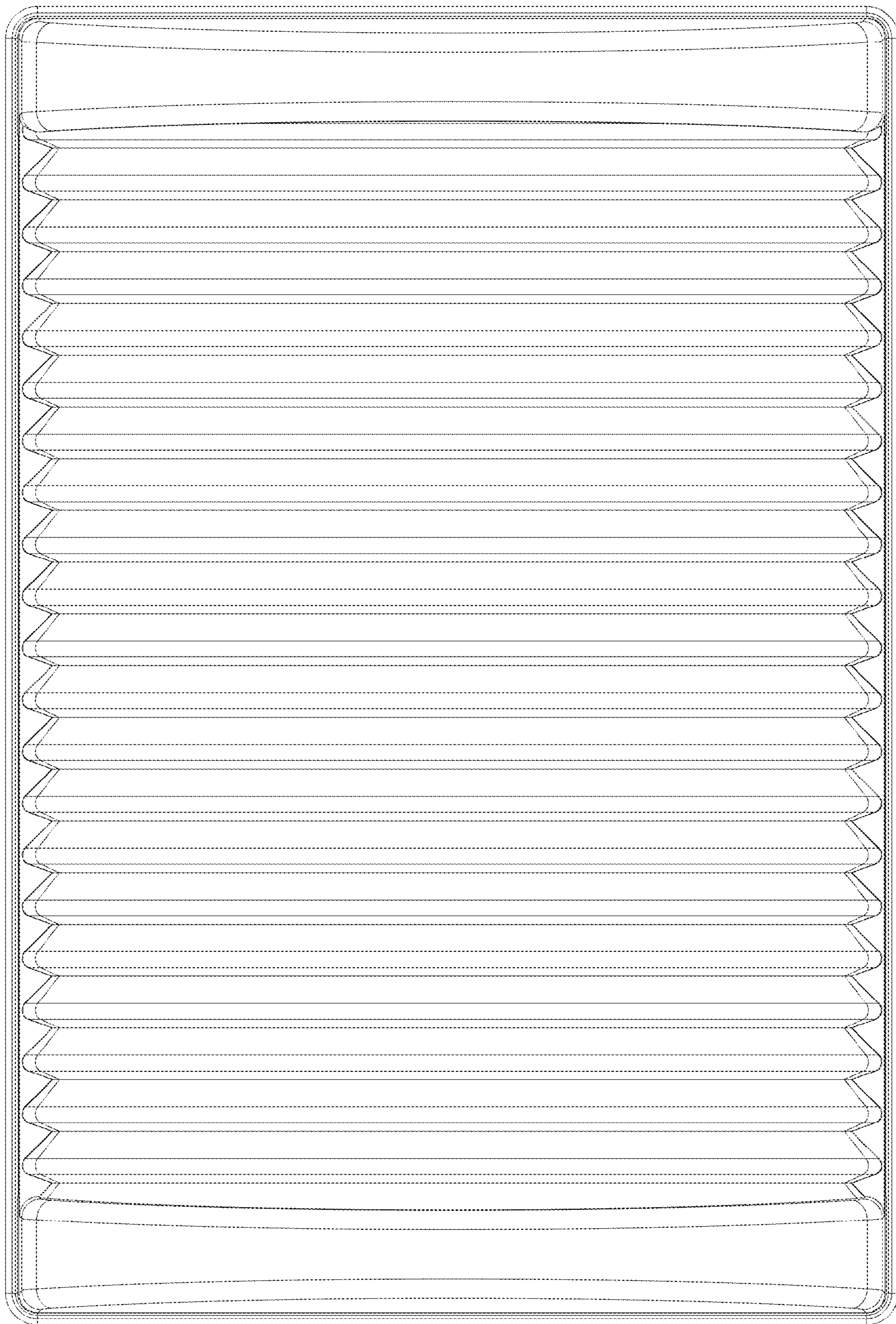

Fig. 3

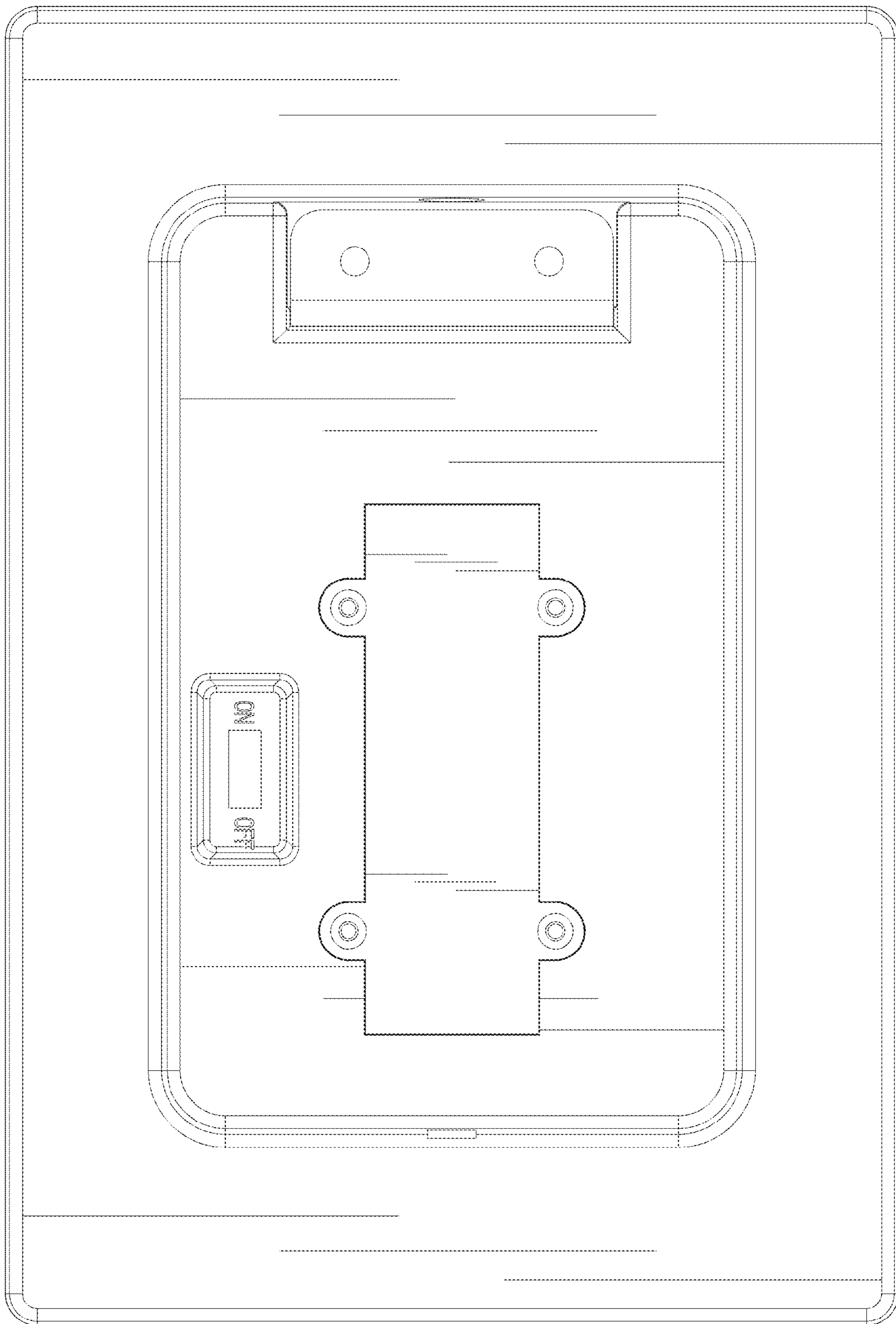

Fig. 4

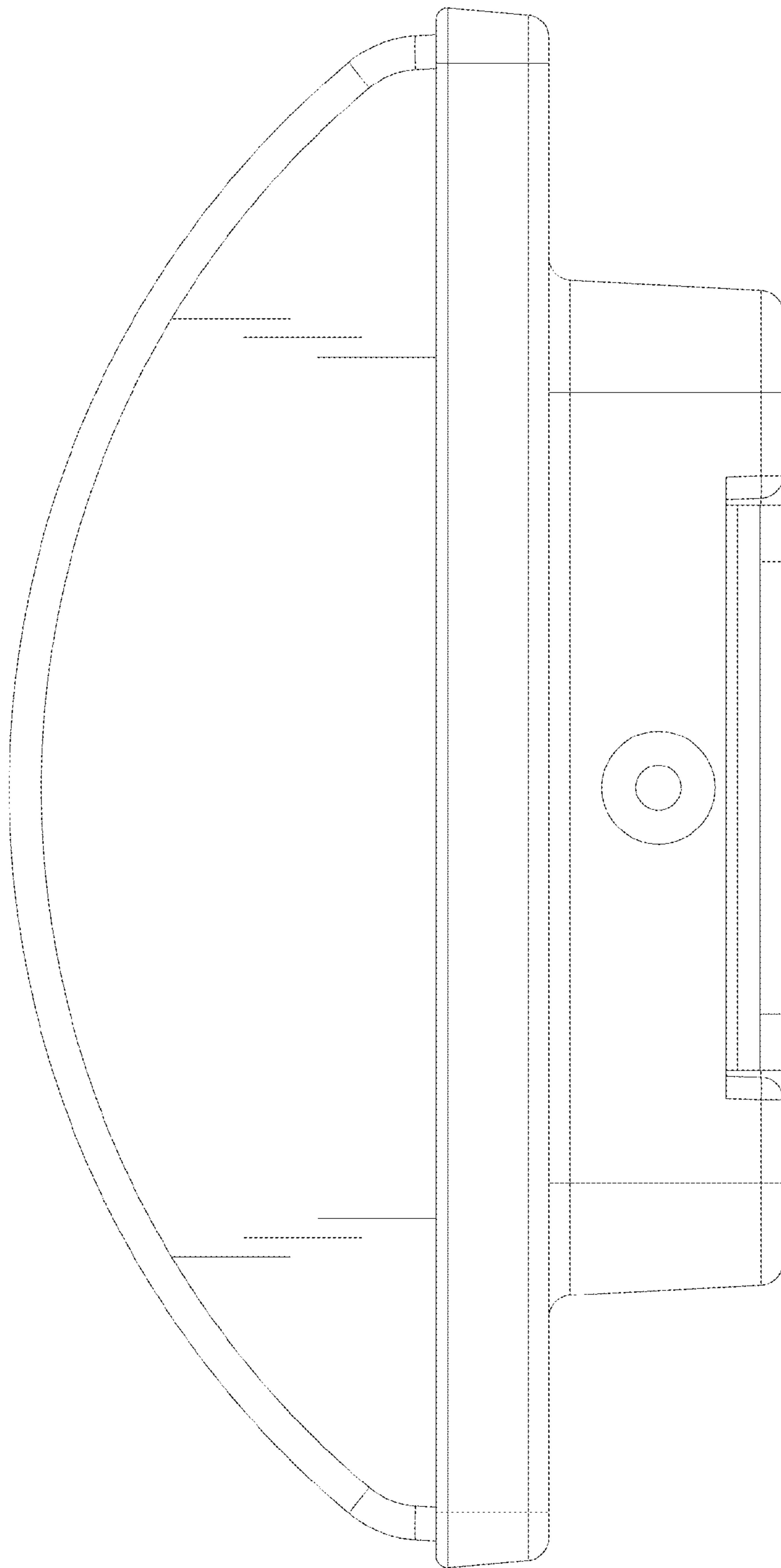

Fig. 5

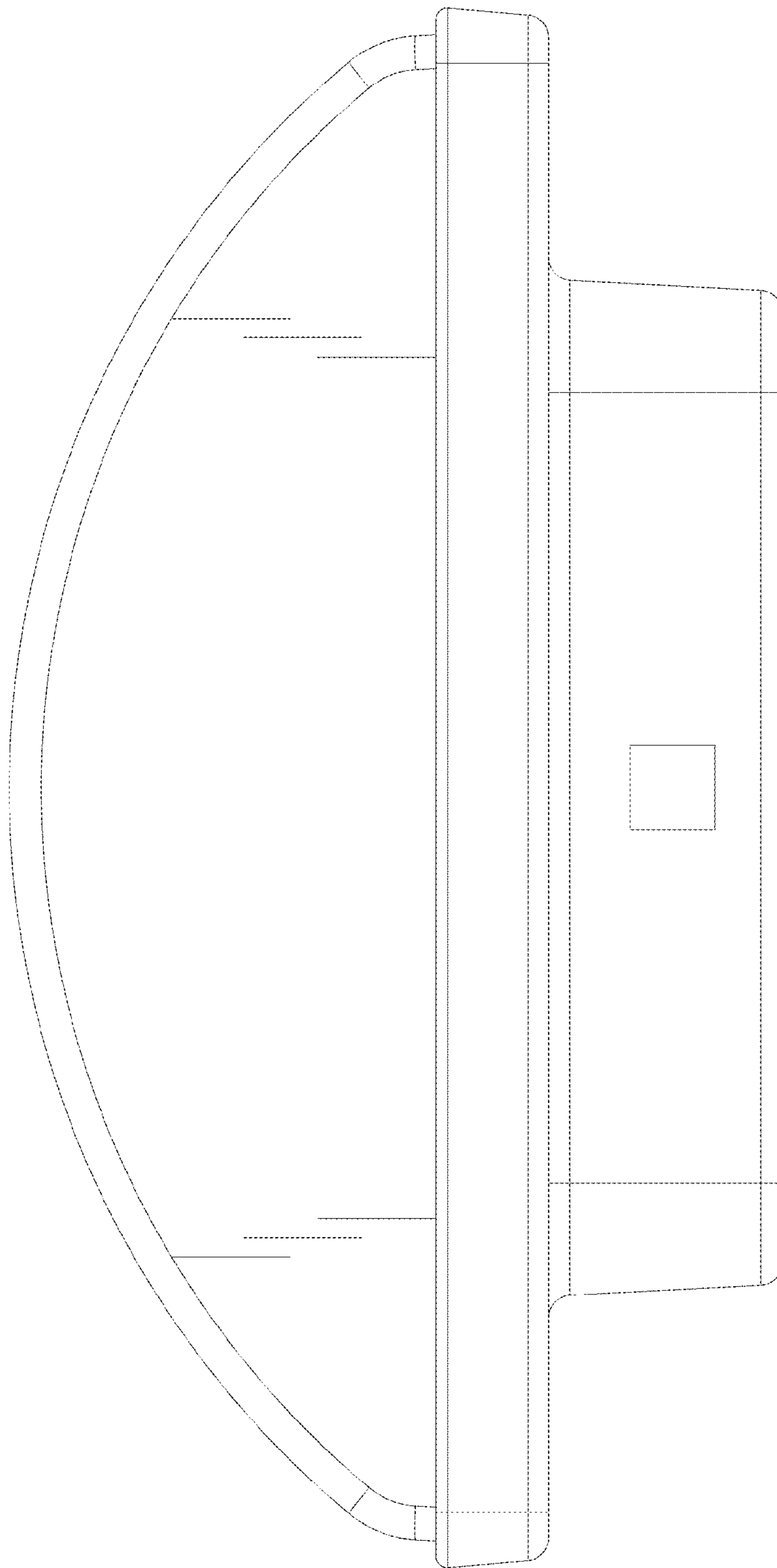

Fig. 6

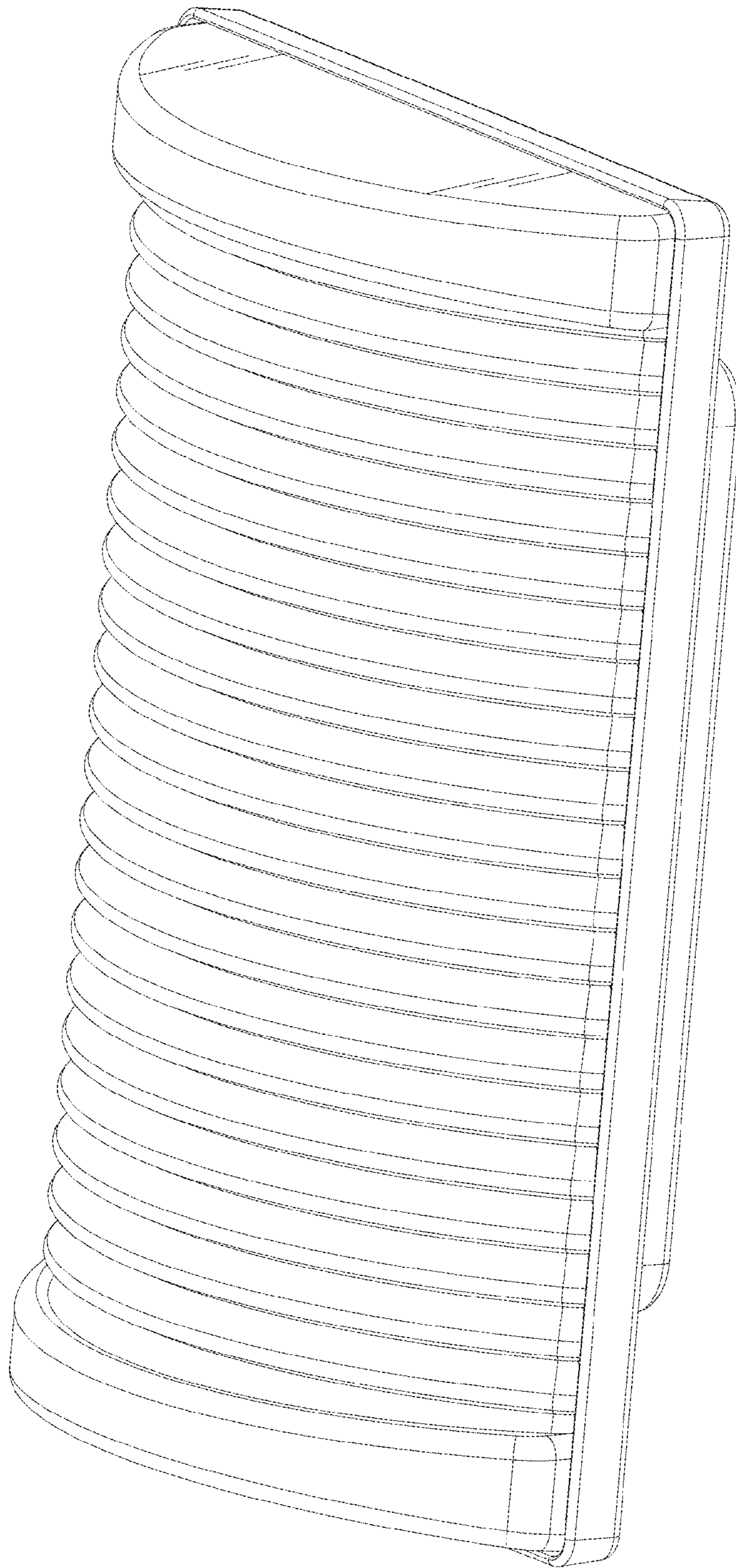

Fig. 7

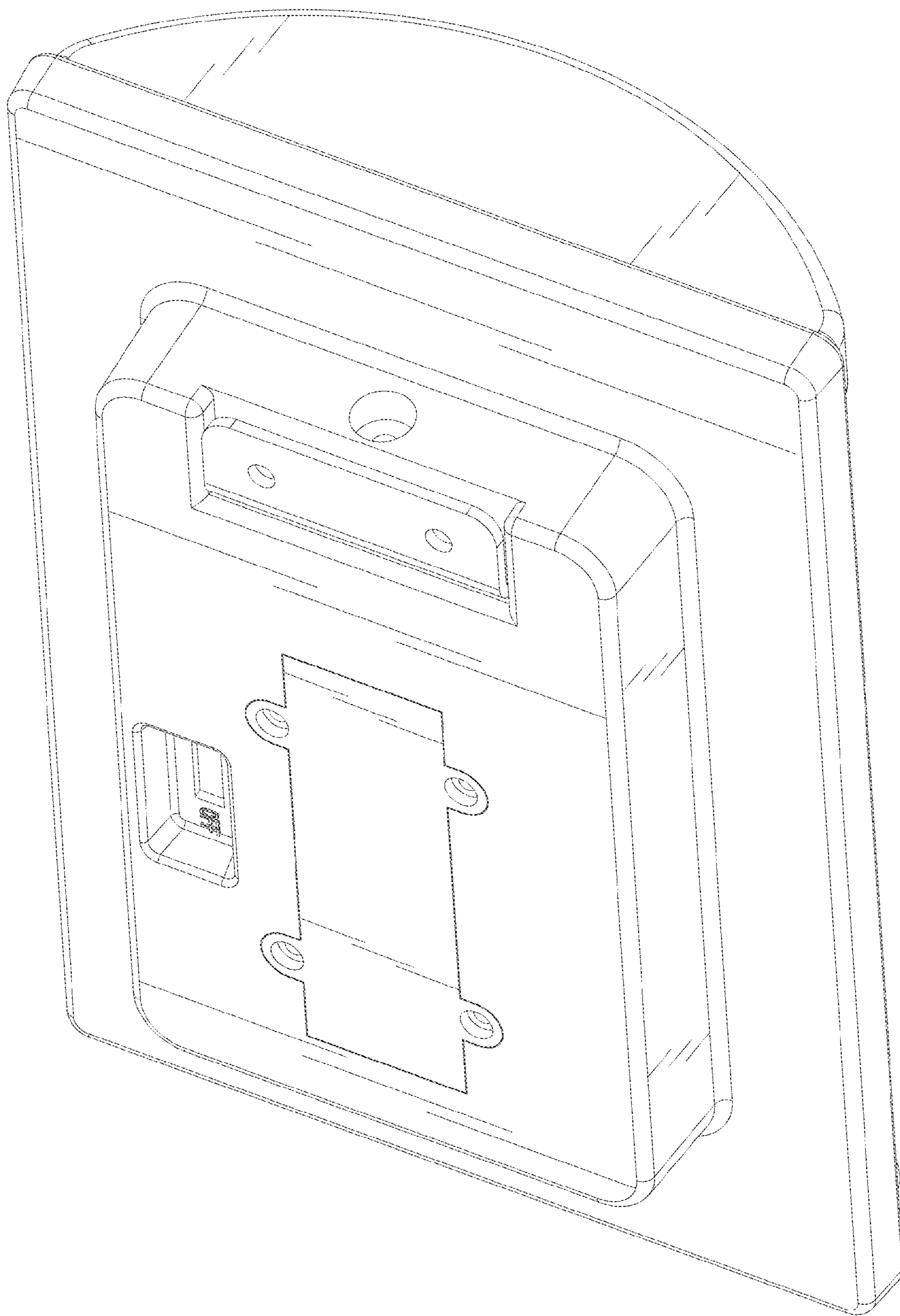

Fig. 8