



US00D927755S

(12) **United States Design Patent**
Liang

(10) **Patent No.:** **US D927,755 S**

(45) **Date of Patent:** **** Aug. 10, 2021**

- (54) **SOLAR WALL LIGHT**
- (71) Applicant: **Qinghui Liang**, Fujian (CN)
- (72) Inventor: **Qinghui Liang**, Fujian (CN)
- (**) Term: **15 Years**
- (21) Appl. No.: **29/686,378**
- (22) Filed: **Apr. 4, 2019**
- (51) **LOC (13) Cl.** **26-05**
- (52) **U.S. Cl.**
USPC **D26/72**
- (58) **Field of Classification Search**
USPC D10/111–115; D26/24, 26, 28, 34, 44,
D26/51, 58, 60, 61, 63, 67, 72, 75, 76,
D26/78, 80, 85, 87, 88, 89, 113, 118,
D26/121, 135
CPC F21S 8/00; F21S 8/02; F21S 8/03; F21S
8/04; F21S 8/033; F21S 8/08; F21S 8/36;
F21S 8/037; F21S 8/043; F21S 9/03;
F21S 9/022; F21S 9/037
See application file for complete search history.

- D375,180 S * 10/1996 Lyons D10/114.1
- D435,131 S * 12/2000 Szymanek D26/75
- 6,484,455 B1 * 11/2002 Poole E04F 17/06
405/284
- 7,395,636 B2 * 7/2008 Blomberg E04D 13/03
359/591
- D672,908 S * 12/2012 Wilcox F21V 23/009
D26/118
- D761,482 S * 7/2016 Largent D26/118
- D784,599 S * 4/2017 Sibitzky D26/118
- D861,947 S * 10/2019 Ma D26/72
- 2013/0271988 A1 * 10/2013 Lin F21V 29/507
362/249.02

* cited by examiner

Primary Examiner — Kevin K Rudzinski
Assistant Examiner — Richard Kearney

(57) **CLAIM**

The ornamental design for a solar wall light, as shown and described.

DESCRIPTION

FIG. 1 is a front elevational view of a solar wall light showing my new design;
FIG. 2 is a rear elevational view thereof;
FIG. 3 is a left side view thereof;
FIG. 4 is a right side view thereof;
FIG. 5 is a top plan view thereof;
FIG. 6 is a bottom plan view thereof;
FIG. 7 is a perspective view thereof; and,
FIG. 8 is another perspective view thereof.

1 Claim, 8 Drawing Sheets

(56) **References Cited**

U.S. PATENT DOCUMENTS

- 2,694,775 A * 11/1954 Florence F21S 8/04
362/222
- D247,725 S * 4/1978 Seymour D26/85
- D357,997 S * 5/1995 Wegrzyn D26/72

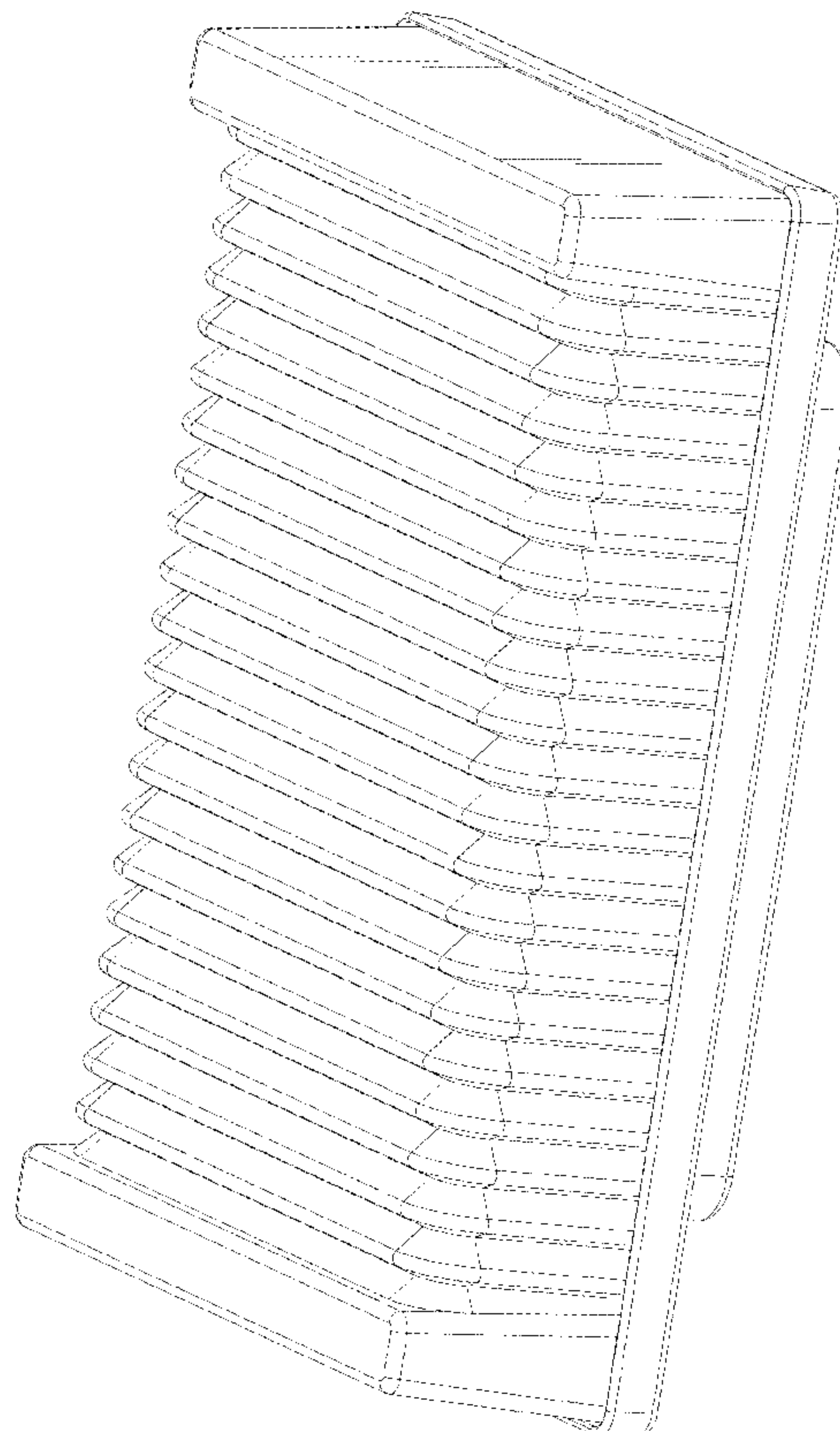

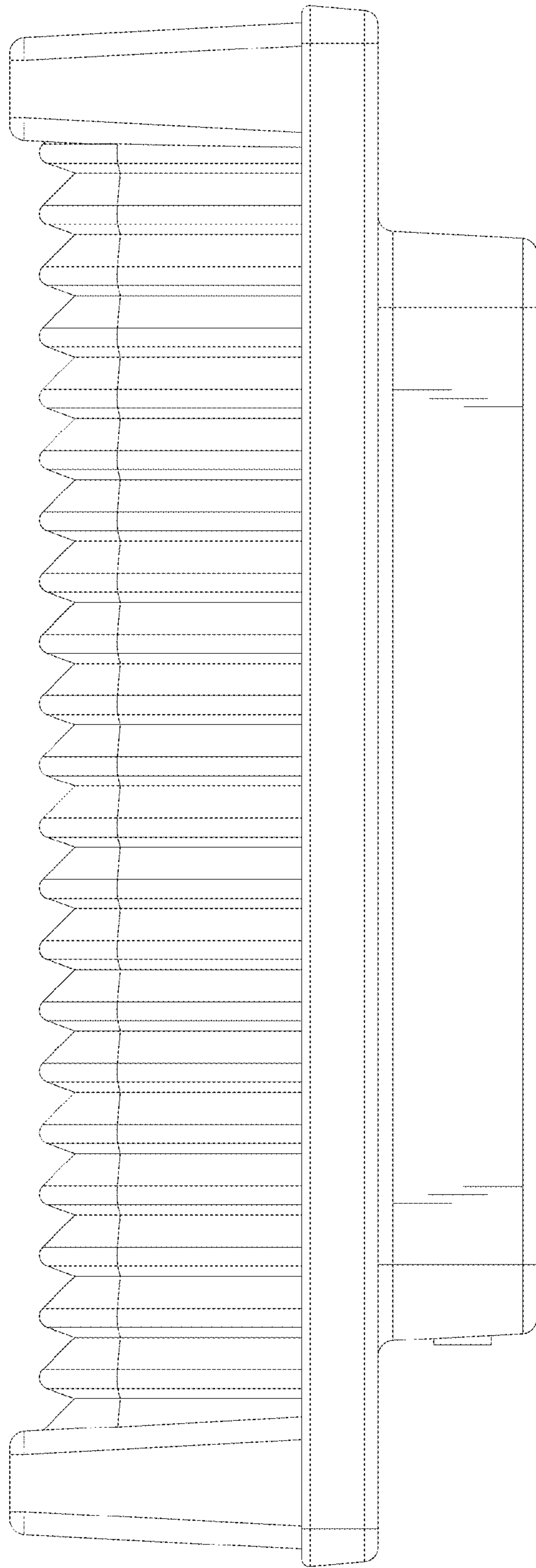

Fig. 1

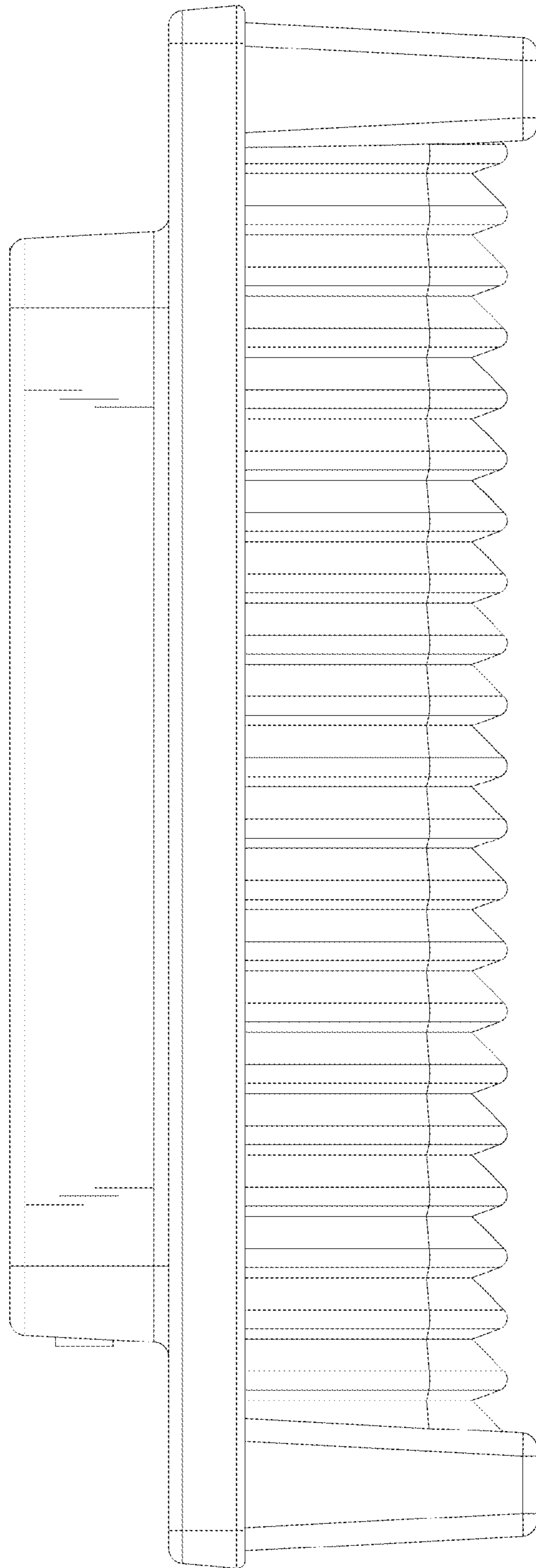

Fig. 2

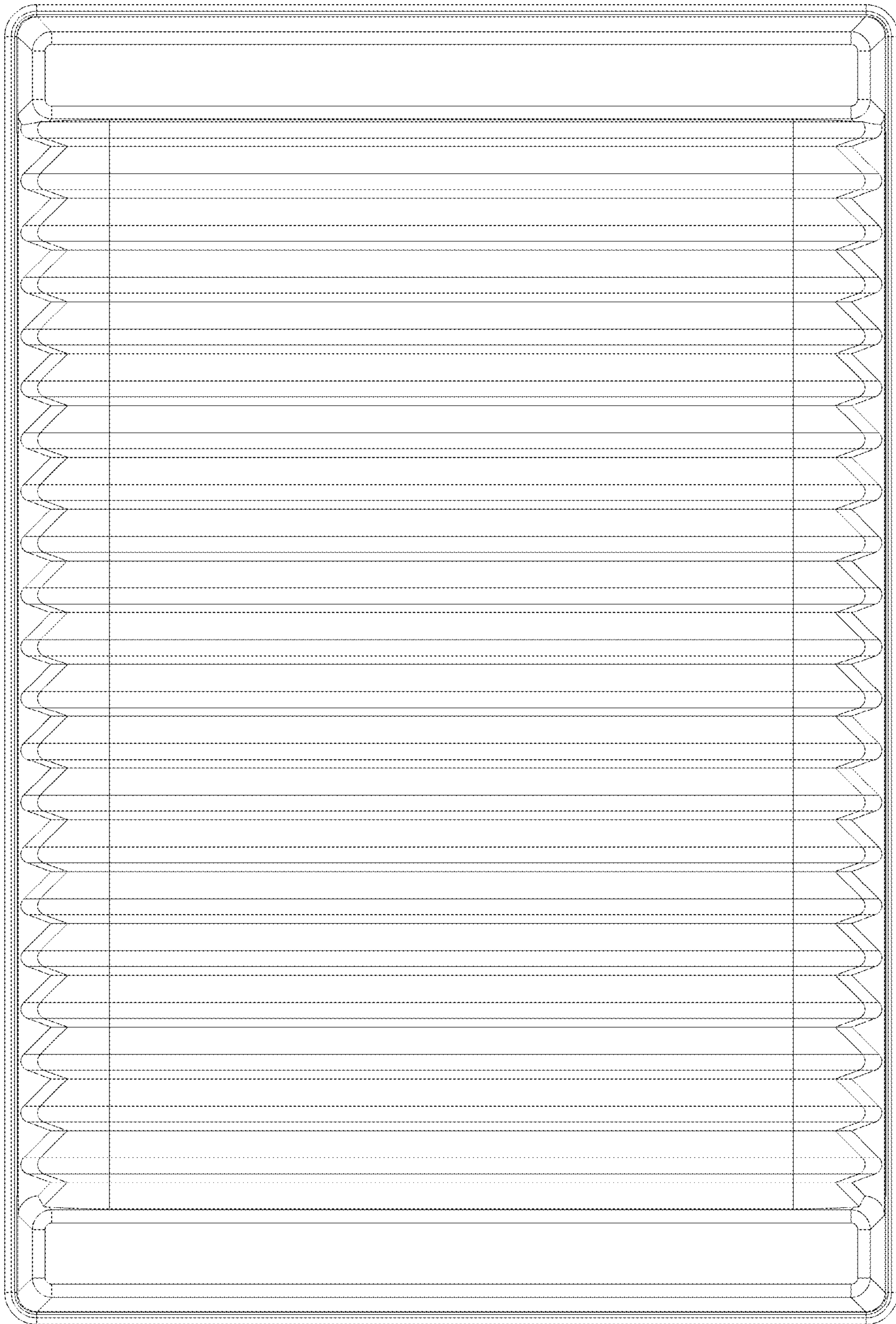

Fig. 3

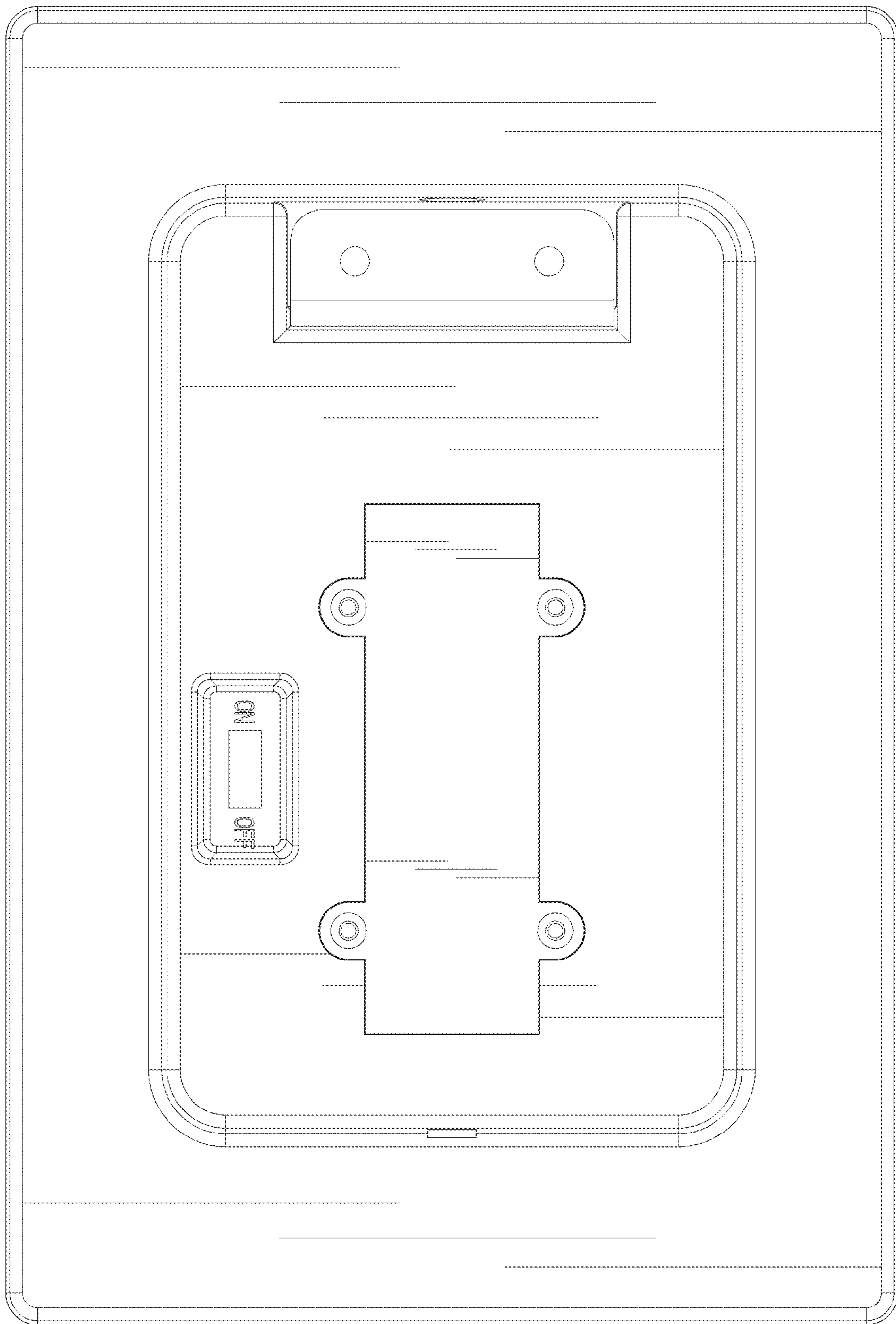

Fig. 4

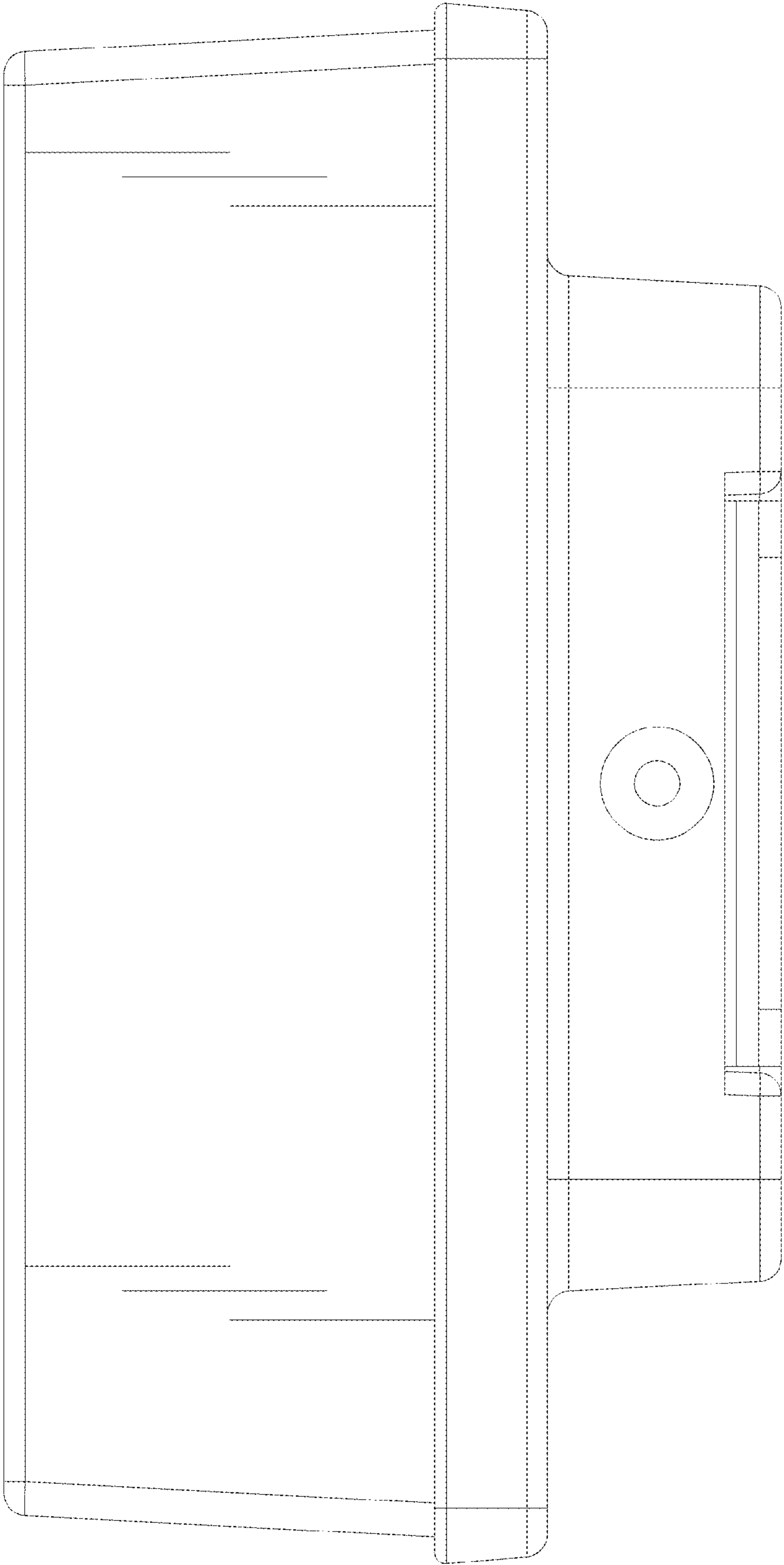

Fig. 5

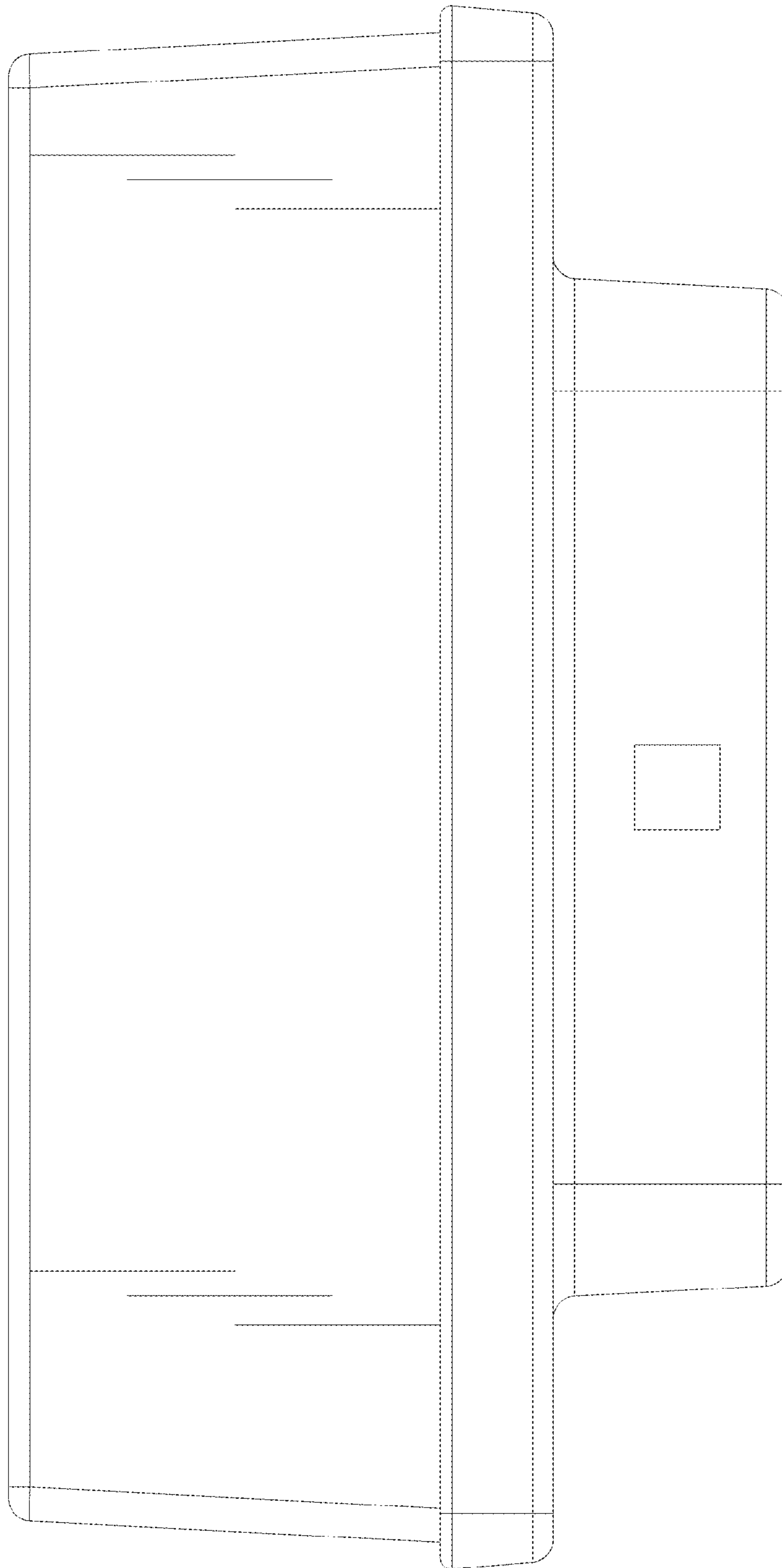

Fig. 6

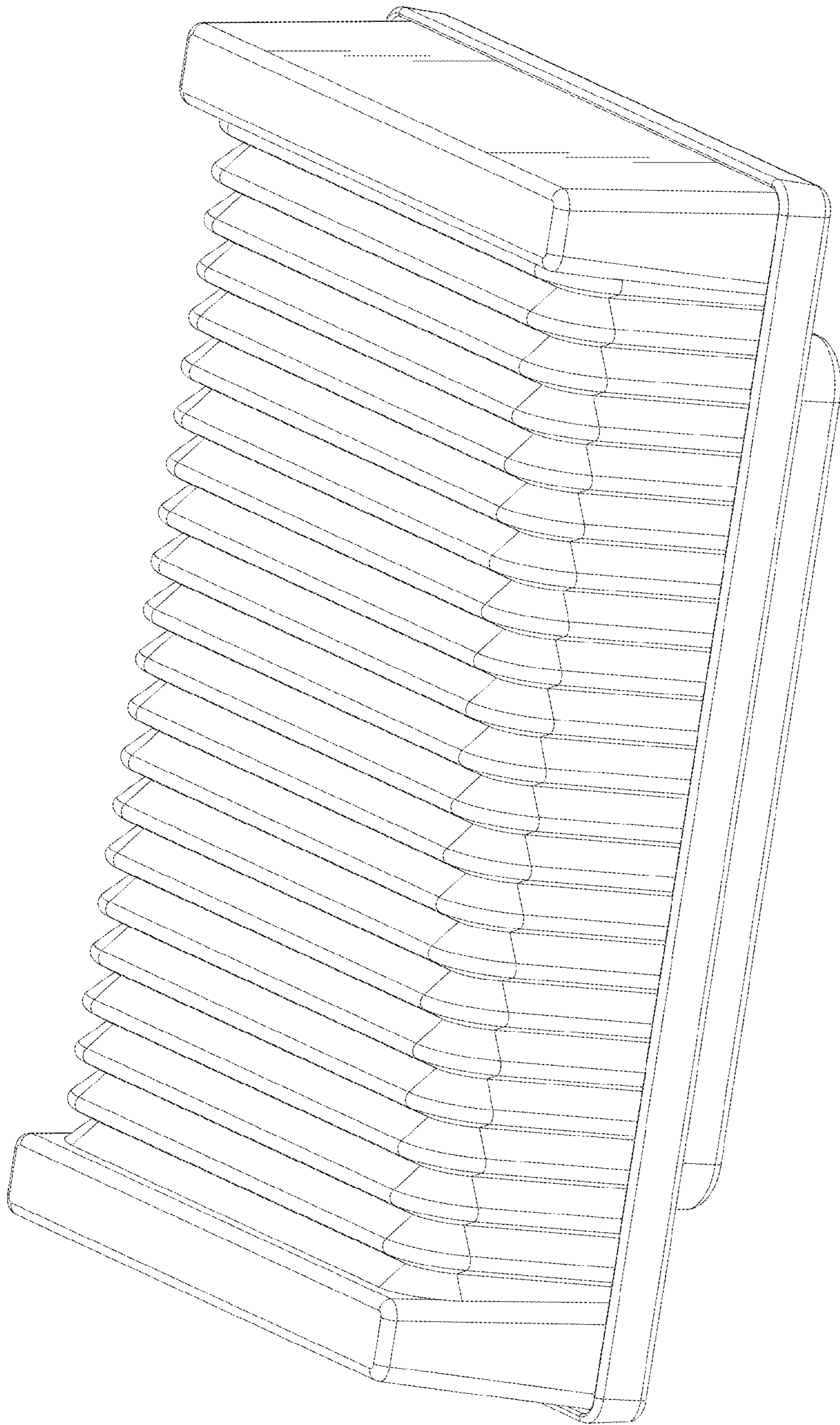

Fig. 7

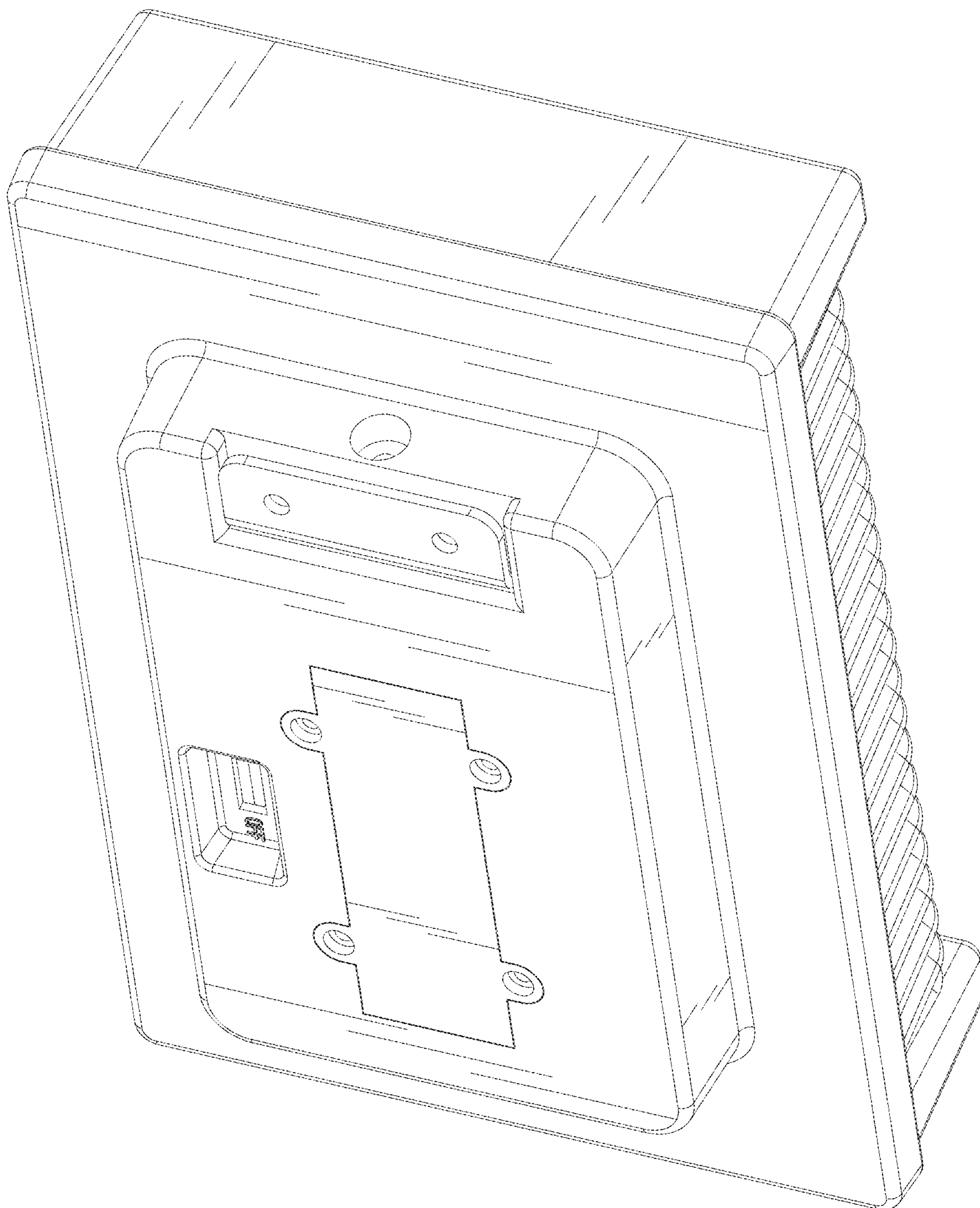

Fig. 8