



US00D927749S

(12) **United States Design Patent** (10) **Patent No.:** **US D927,749 S**
Dai (45) **Date of Patent:** **** Aug. 10, 2021**

- (54) **WORK LIGHT**
- (71) Applicant: **Ruiding Dai**, Zhejiang (CN)
- (72) Inventor: **Ruiding Dai**, Zhejiang (CN)
- (73) Assignee: **Ruiding Dai**, Ningbo (CN)
- (**) Term: **15 Years**
- (21) Appl. No.: **29/716,194**
- (22) Filed: **Dec. 6, 2019**
- (51) **LOC (13) Cl.** **26-02**
- (52) **U.S. Cl.**
USPC **D26/37**
- (58) **Field of Classification Search**
USPC D26/37-51
CPC F21L 2003/00; F21L 4/005; F21L 13/00;
F21L 13/08; F21L 14/02; F21L 19/00;
F21L 2/00; F21L 4/00-4/085; F21L
15/00-15/14; F21L 2001/00; F21L
2005/00; F21L 25/00
See application file for complete search history.

D742,568 S *	11/2015	Abernethy	D26/42
D753,855 S *	4/2016	Cacciabeve	D26/37
D757,971 S *	5/2016	Kovacik	D26/37
D767,184 S *	9/2016	Fitch	D26/44
D816,876 S *	5/2018	Bao	D26/37
D818,166 S *	5/2018	Bao	D26/44
D836,229 S *	12/2018	Jeon	D26/44
D889,714 S *	7/2020	Green	D26/43
D899,648 S *	10/2020	Qiu	D26/49

* cited by examiner

Primary Examiner — Michelle E. Wilson

(74) *Attorney, Agent, or Firm* — Dragon Sun Law Firm, PC; Jinggao Li Esq.

(57) **CLAIM**

The ornamental design for a work light, as shown and described.

DESCRIPTION

FIG. 1 is a front, left and top perspective view of a work light showing my new design;
 FIG. 2 is a rear and right perspective view thereof;
 FIG. 3 is a front elevation view thereof;
 FIG. 4 is a rear elevation view thereof;
 FIG. 5 is a left side elevation view thereof;
 FIG. 6 is a right side elevation view thereof;
 FIG. 7 is a top plan view thereof; and,
 FIG. 8 is a bottom plan view thereof.
 The broken lines show portions of the article which form no part of the claimed design.

1 Claim, 8 Drawing Sheets

(56) **References Cited**

U.S. PATENT DOCUMENTS

D502,276 S *	2/2005	Kovacik	D26/44
D549,374 S *	8/2007	Yuen	D26/45
D604,435 S *	11/2009	Kingston	D26/37
D648,054 S *	11/2011	Zhuang	D26/37
D677,412 S *	3/2013	Smith	D26/37
D695,434 S *	12/2013	Shen	D26/41
D712,080 S *	8/2014	Trude	D26/37

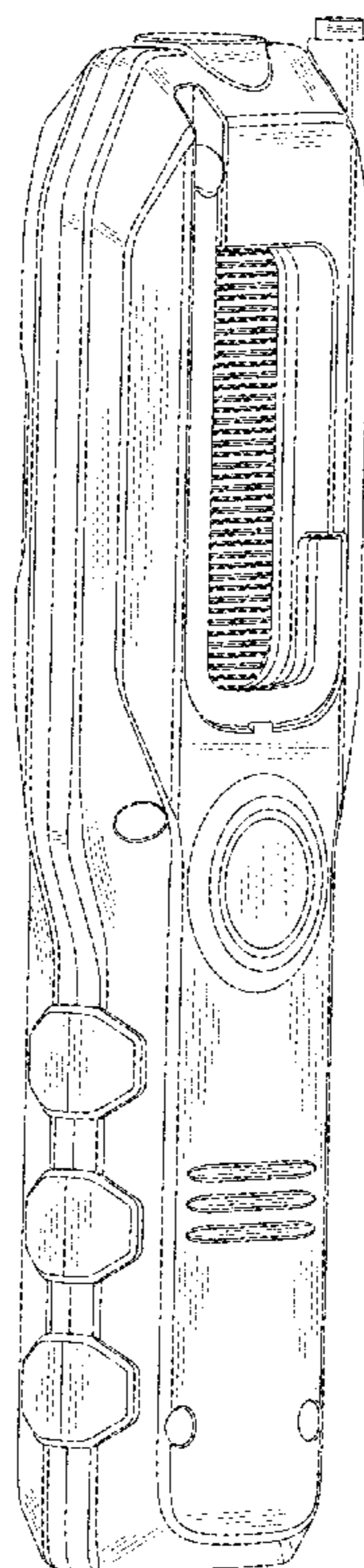

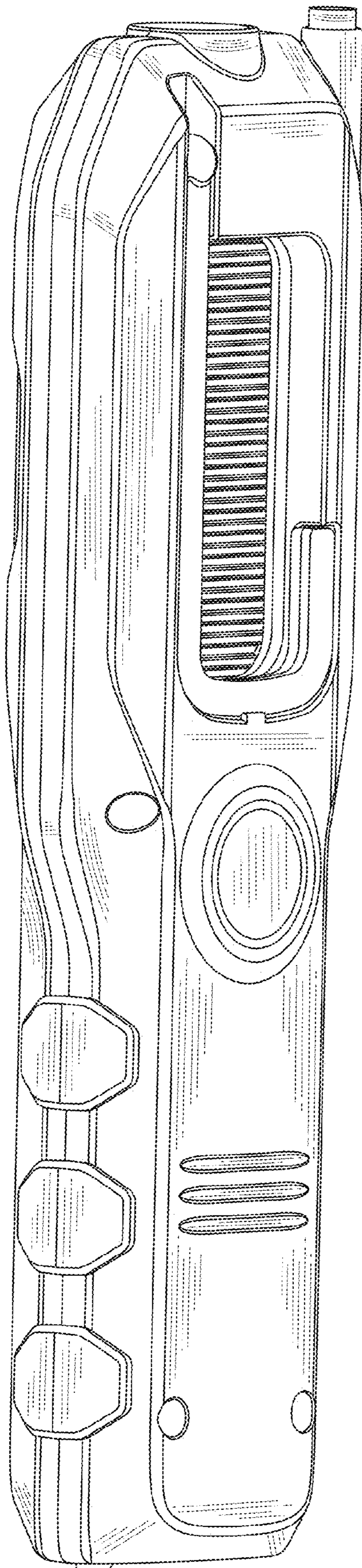

FIG. 1

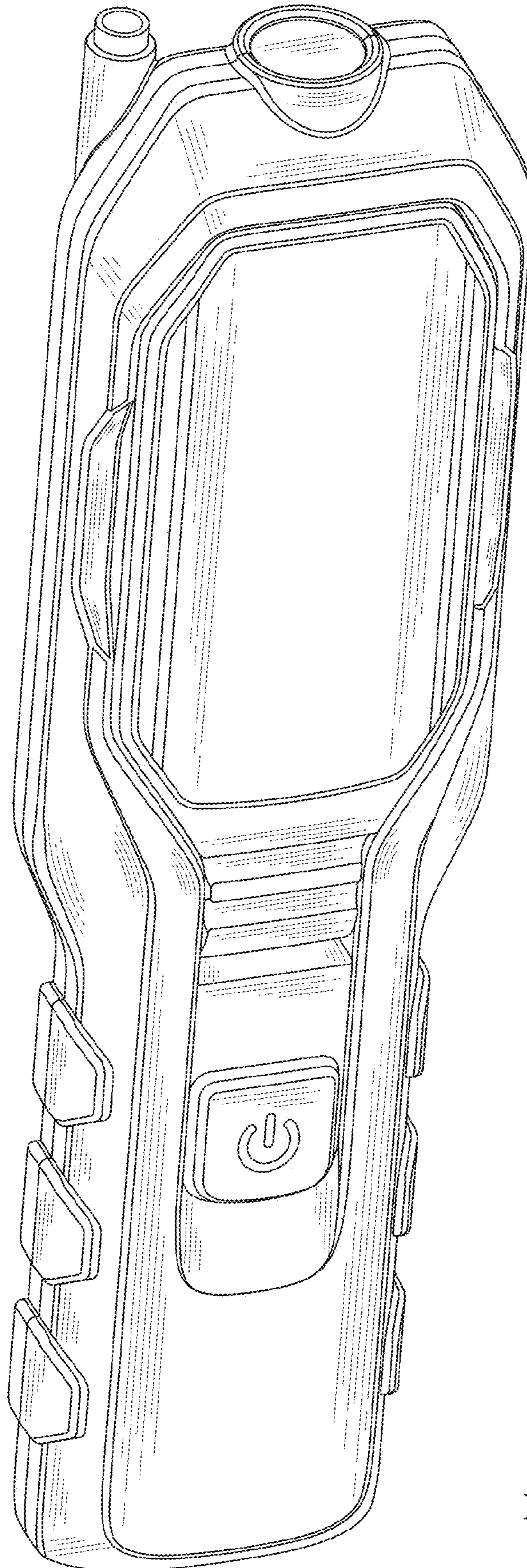

FIG. 2

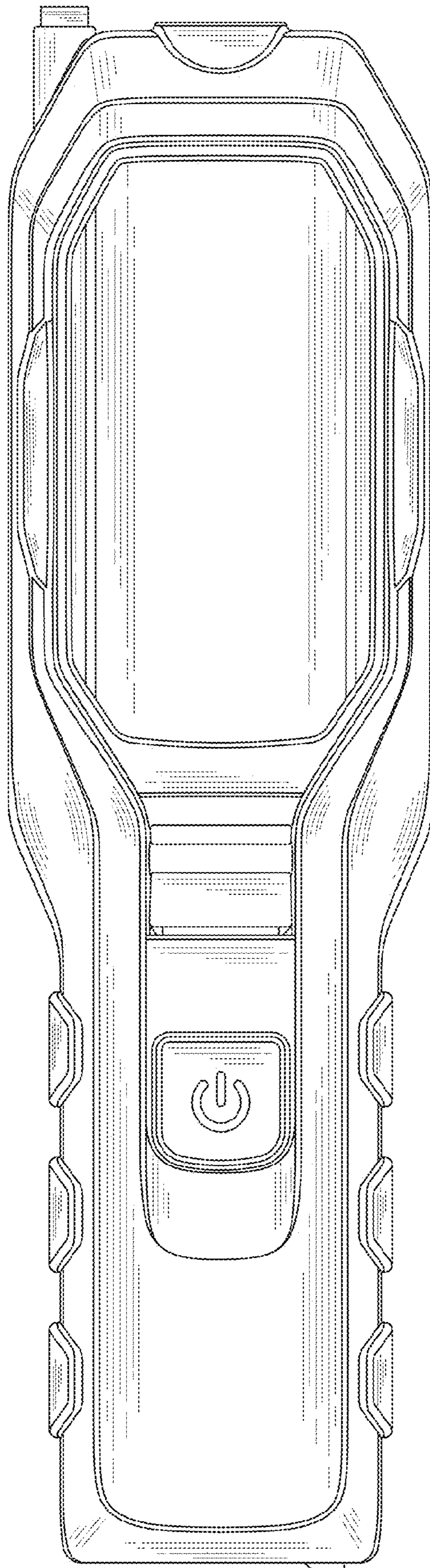

FIG. 3

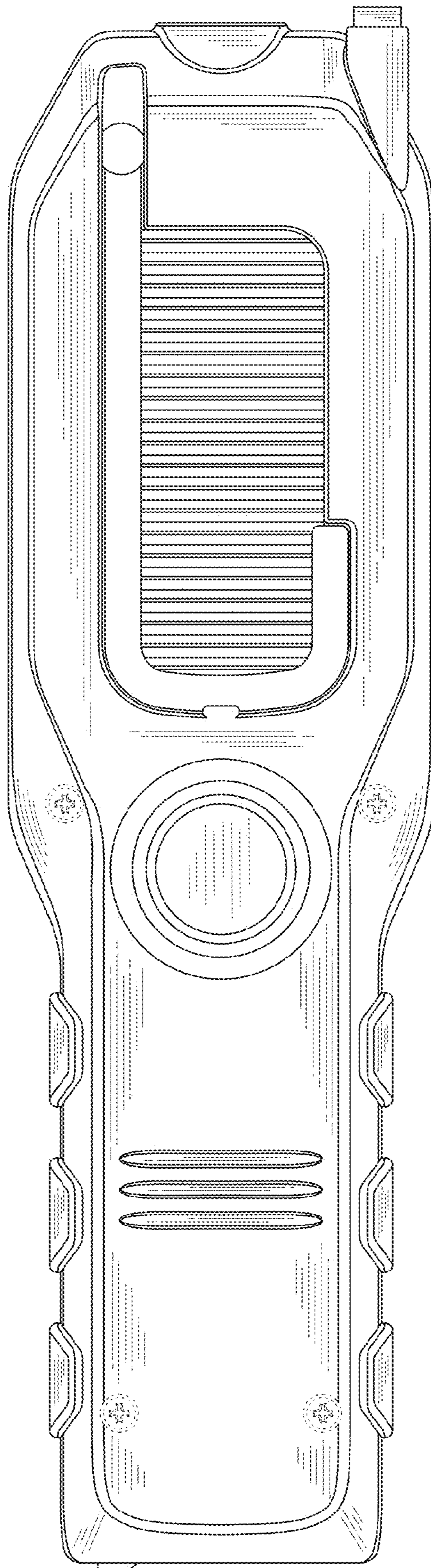

FIG. 4

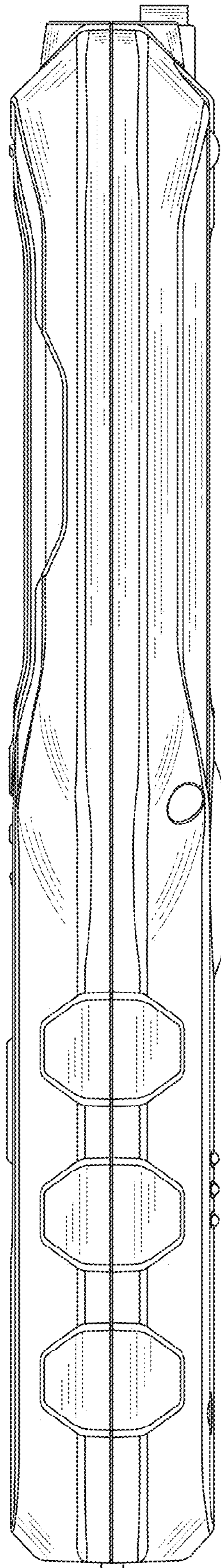

FIG. 5

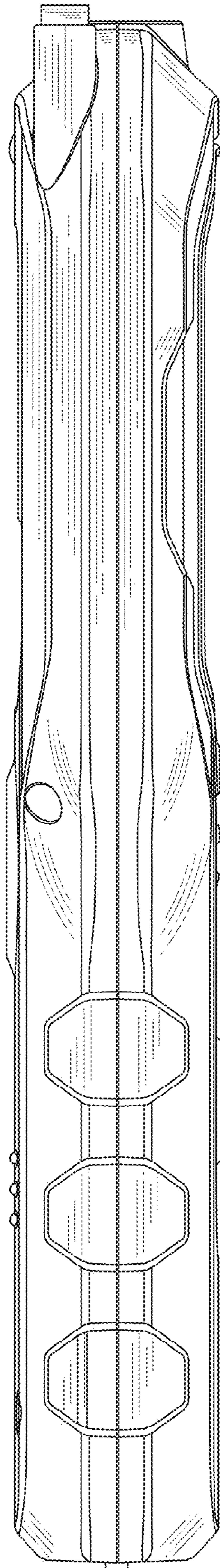

FIG. 6

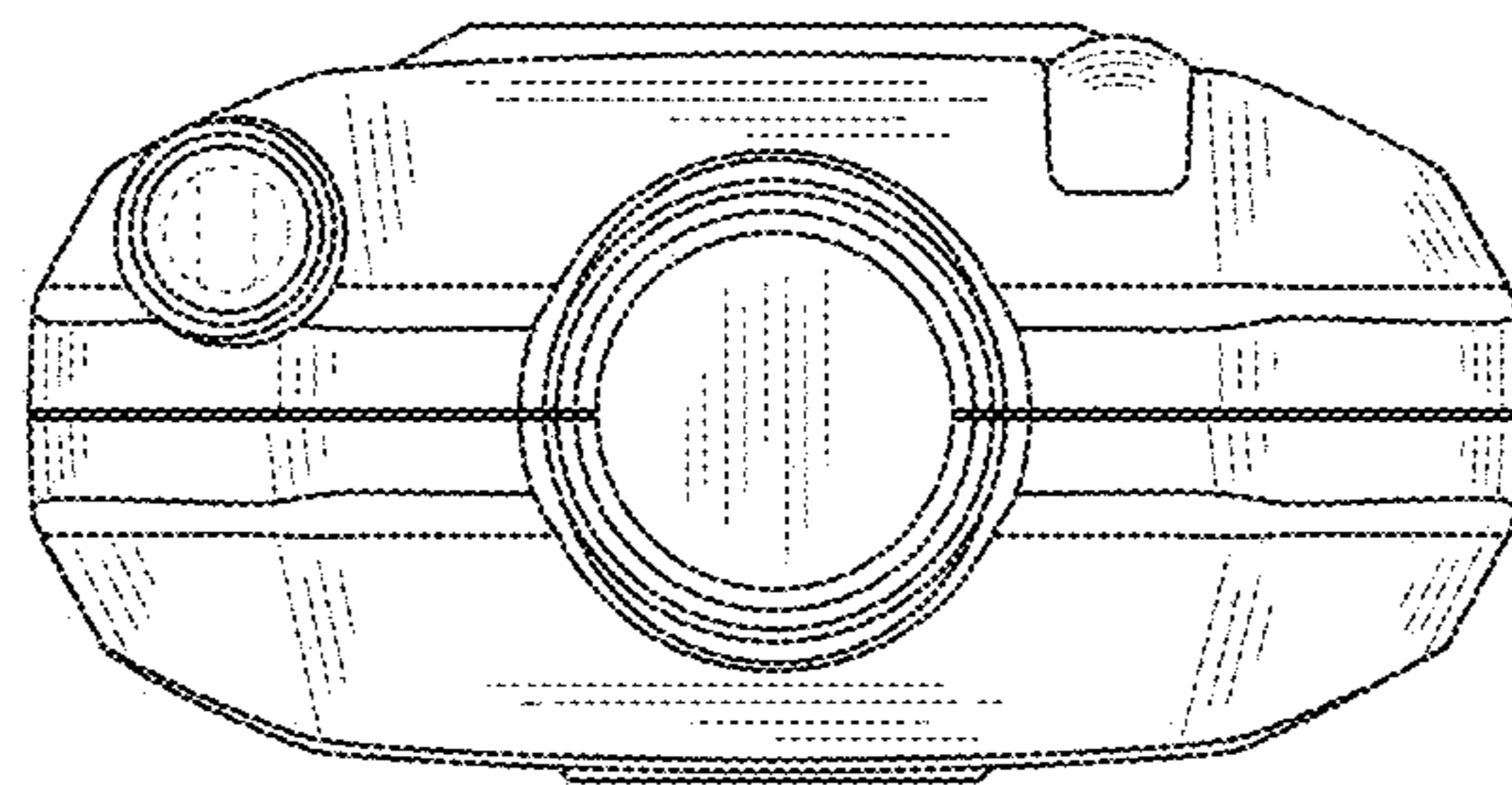

FIG. 7

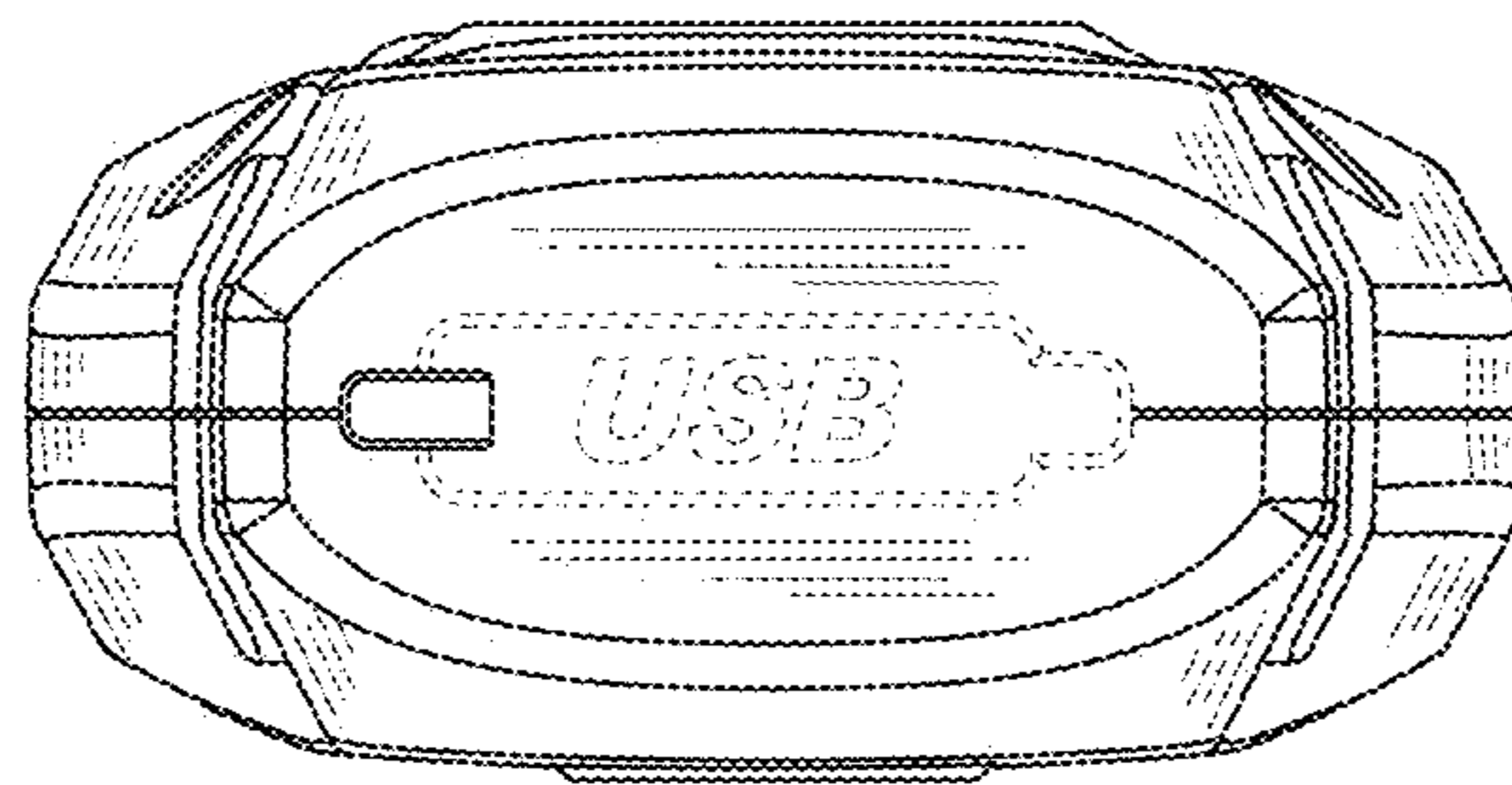

FIG. 8