



US00D927630S

(12) **United States Design Patent**  
**Hsu**

(10) **Patent No.:** **US D927,630 S**

(45) **Date of Patent:** **\*\* Aug. 10, 2021**

(54) **INFLATABLE PILLOW-BACKED LOUNGE  
FLOAT**

(71) Applicant: **Intex Marketing Ltd.**, Tortola (VG)

(72) Inventor: **Kun Chao Hsu**, Fujian (CN)

(73) Assignee: **Intex Marketing Ltd.**, Tortola (VG)

(\*\*) Term: **15 Years**

(21) Appl. No.: **29/713,355**

(22) Filed: **Nov. 15, 2019**

(30) **Foreign Application Priority Data**

Jun. 4, 2019 (CN) ..... 201930285163.2

(51) **LOC (13) Cl.** ..... **21-01**

(52) **U.S. Cl.**  
USPC ..... **D21/803**

(58) **Field of Classification Search**  
USPC ..... D6/597-599, 601; D12/316; D21/803,  
D21/805-806, 808, 809  
CPC .. A63B 21/4005; A47C 15/006; A47C 15/008  
See application file for complete search history.

(56) **References Cited**

**U.S. PATENT DOCUMENTS**

- D397,740 S \* 9/1998 Georgevich ..... D20/29
- D473,769 S \* 4/2003 Kelleghan ..... D8/18
- D538,875 S 3/2007 Rockstad
- D585,727 S \* 2/2009 Kelleghan ..... D8/356
- D603,926 S 11/2009 Merker
- D626,192 S 10/2010 Hunter
- D654,245 S \* 2/2012 School ..... D99/5
- D656,280 S \* 3/2012 St. Clair ..... D30/129
- D661,456 S \* 6/2012 Couttenye ..... D1/107
- D676,202 S \* 2/2013 Hansen ..... D30/199
- D693,862 S \* 11/2013 Wirth, Jr. .... D15/140
- D759,339 S \* 6/2016 Smith ..... D99/5

(Continued)

**FOREIGN PATENT DOCUMENTS**

- CN 304695509 S 6/2018
- CN 304695512 S 6/2018
- CN 304822075 S 9/2018

**OTHER PUBLICATIONS**

“Intex Bear Paw Glitter Lounge” Jun. 23, 2020, site visited Mar. 22, 2021: <https://www.walmart.com/ip/Intex-Bear-Paw-Glitter-Lounge/726266950> (Year: 2020).\*

(Continued)

*Primary Examiner* — Michael C Stout

*Assistant Examiner* — Melvin L Davis

(74) *Attorney, Agent, or Firm* — Faegre Drinker Biddle & Reath LLP

(57) **CLAIM**

The ornamental design for an inflatable pillow-backed lounge float, as shown and described.

**DESCRIPTION**

FIG. 1 is a front perspective view of an inflatable pillow-backed lounge float showing my new design; FIG. 2 is a front elevational view thereof; FIG. 3 is a rear elevational view thereof; FIG. 4 is a left side elevational view thereof; FIG. 5 is a right side elevational view thereof; FIG. 6 is a top plan view thereof; FIG. 7 is a bottom plan view thereof; and, FIG. 8 is another front perspective view thereof. The speckling in the drawings depicts confetti-like objects that are visible through transparent surfaces and loosely carried within the interior of the inflatable pillow-backed lounge float. The broken lines in the drawings depict portions of the inflatable pillow-backed lounge float that form no part of the claimed design.

**1 Claim, 8 Drawing Sheets**

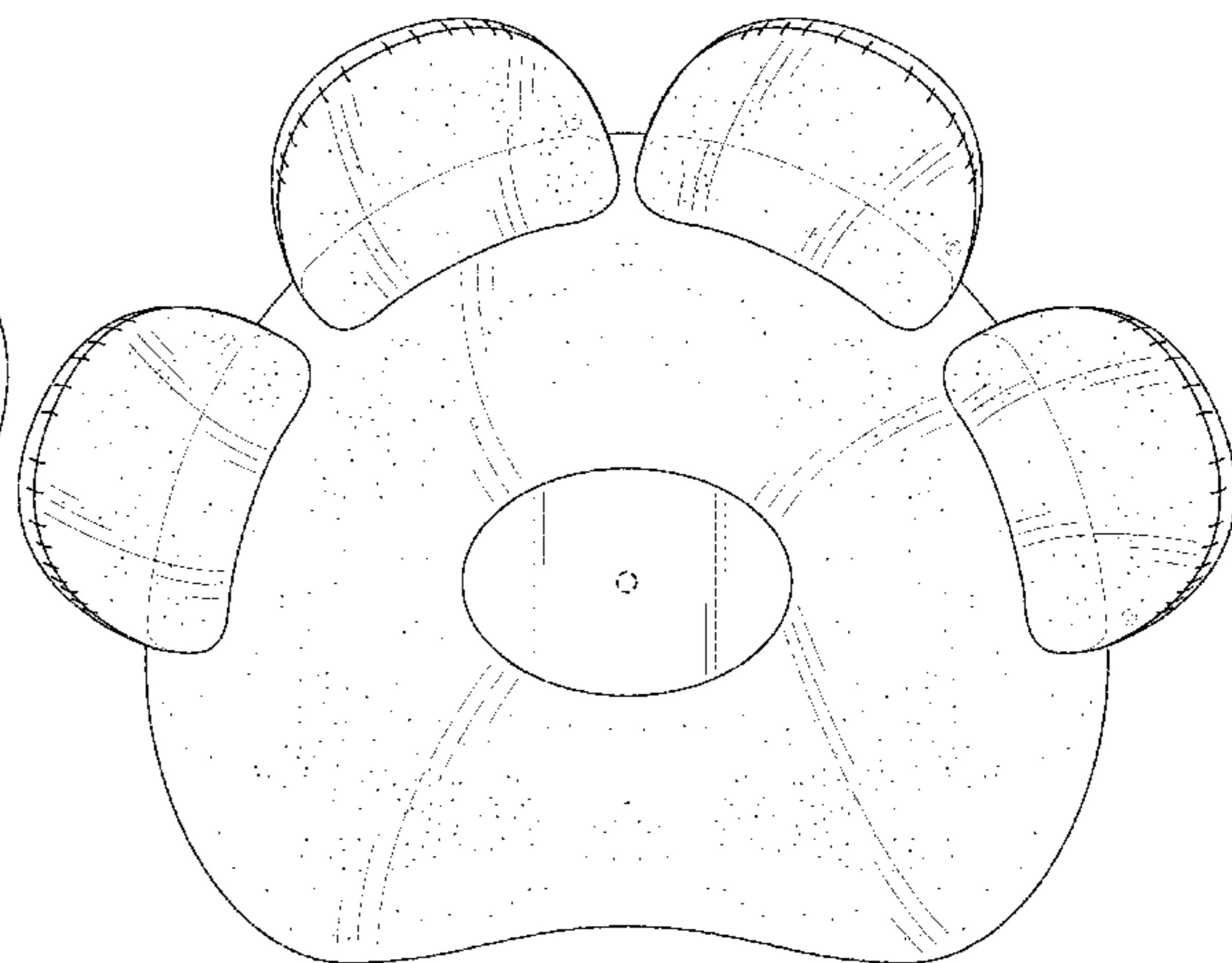
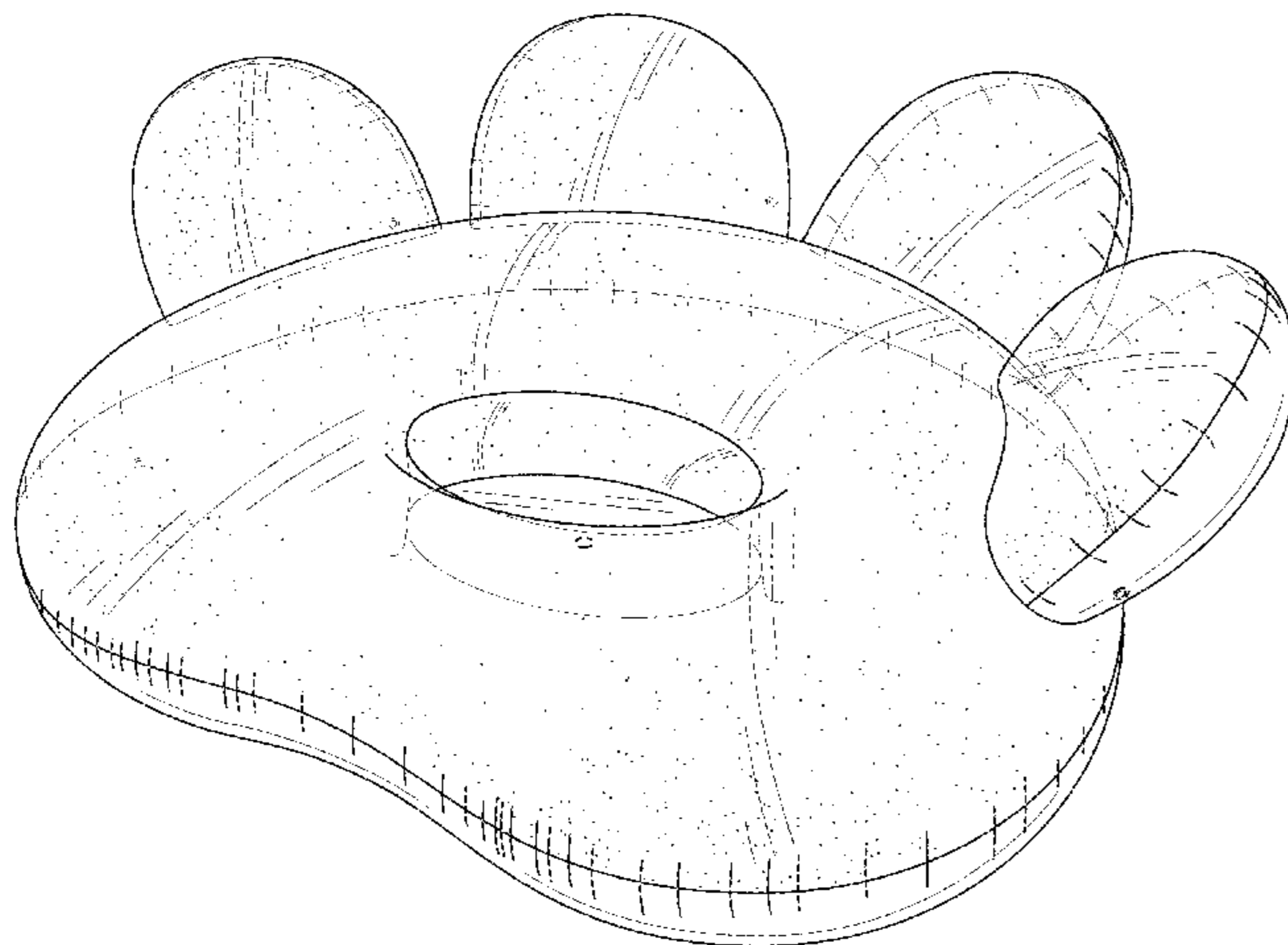

(56)

**References Cited**

U.S. PATENT DOCUMENTS

D785,120	S	4/2017	Wampold	
D790,021	S	6/2017	Su	
D793,513	S	8/2017	George et al.	
D796,953	S *	9/2017	Katopis .....	D9/451
D812,594	S *	3/2018	Katopis .....	D14/223
D819,901	S *	6/2018	Bone .....	D30/199
D859,776	S *	9/2019	Khan .....	D99/5
D869,817	S *	12/2019	White .....	D1/109
D874,273	S *	2/2020	Katopis .....	D9/451
D902,504	S *	11/2020	Katopis .....	D30/159
2012/0068396	A1 *	3/2012	Wirth, Jr. ....	B23Q 1/032 269/289 R

OTHER PUBLICATIONS

Kooltail Paw Dog Pool Float Large Inflatable Raft for Pets 49"x46"x3.5". Website visited Nov. 13, 2019, copyright 2019, publication date unknown. Available online at <http://www.offdeziqn.com/swimming-ring/kooltail-paw-dog-pool-float-large-inflatable-raft-for-pets-49-x-46-x-3.5-b07b9pxz8k.html>. 1 page.

\* cited by examiner

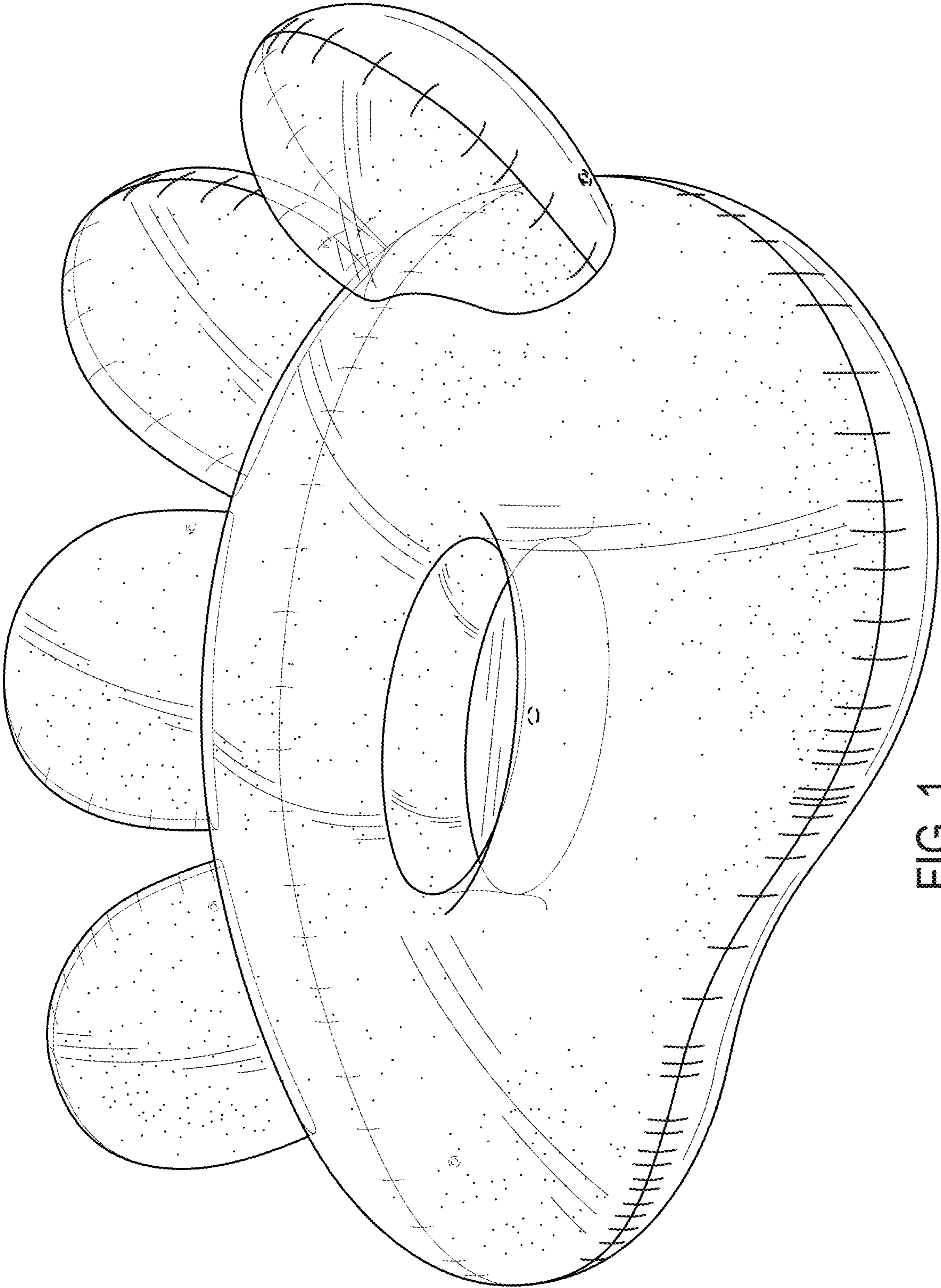

FIG. 1

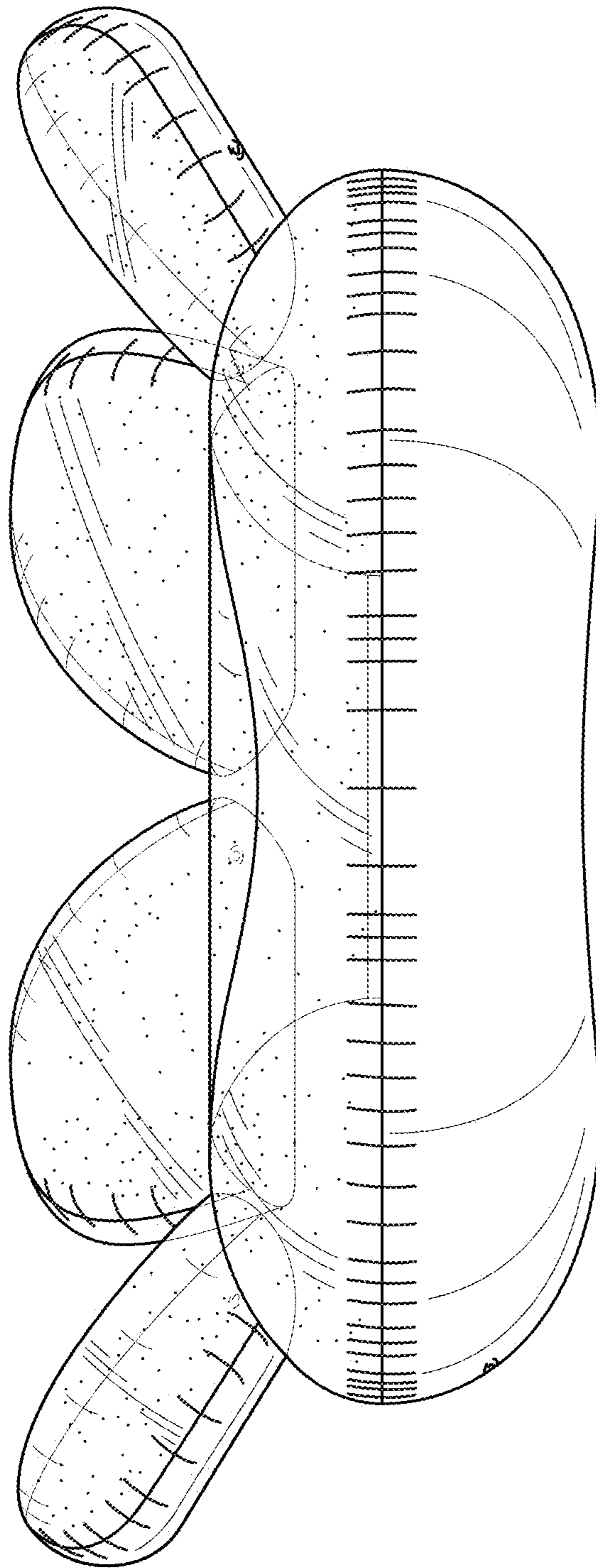

FIG. 2

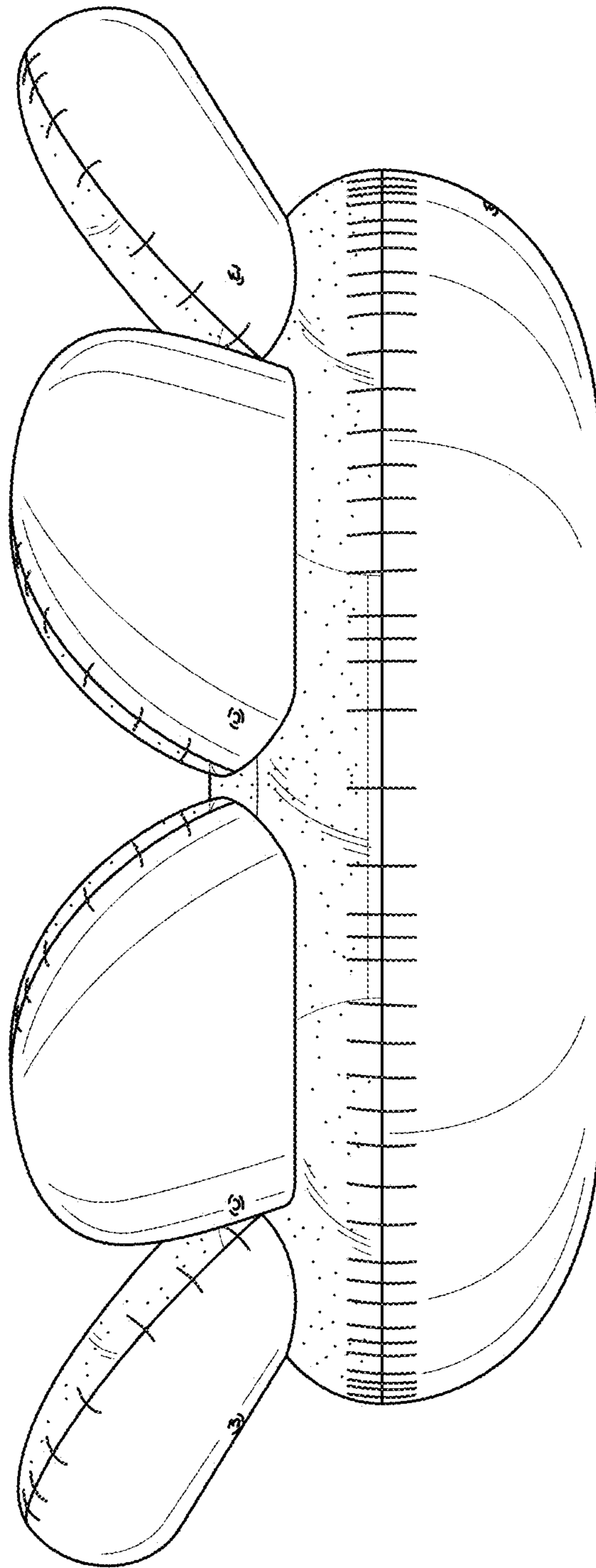

FIG. 3

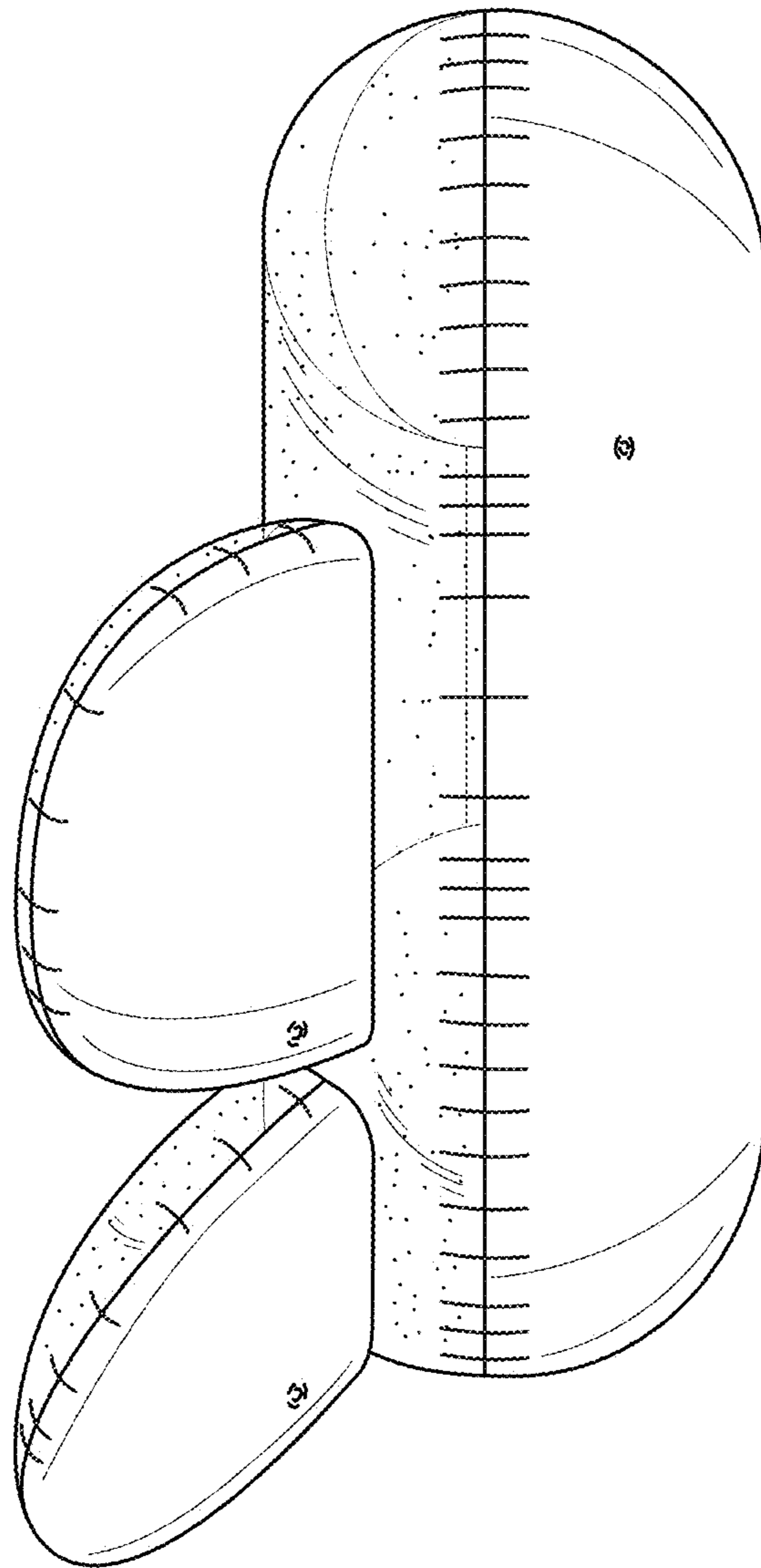

FIG. 4

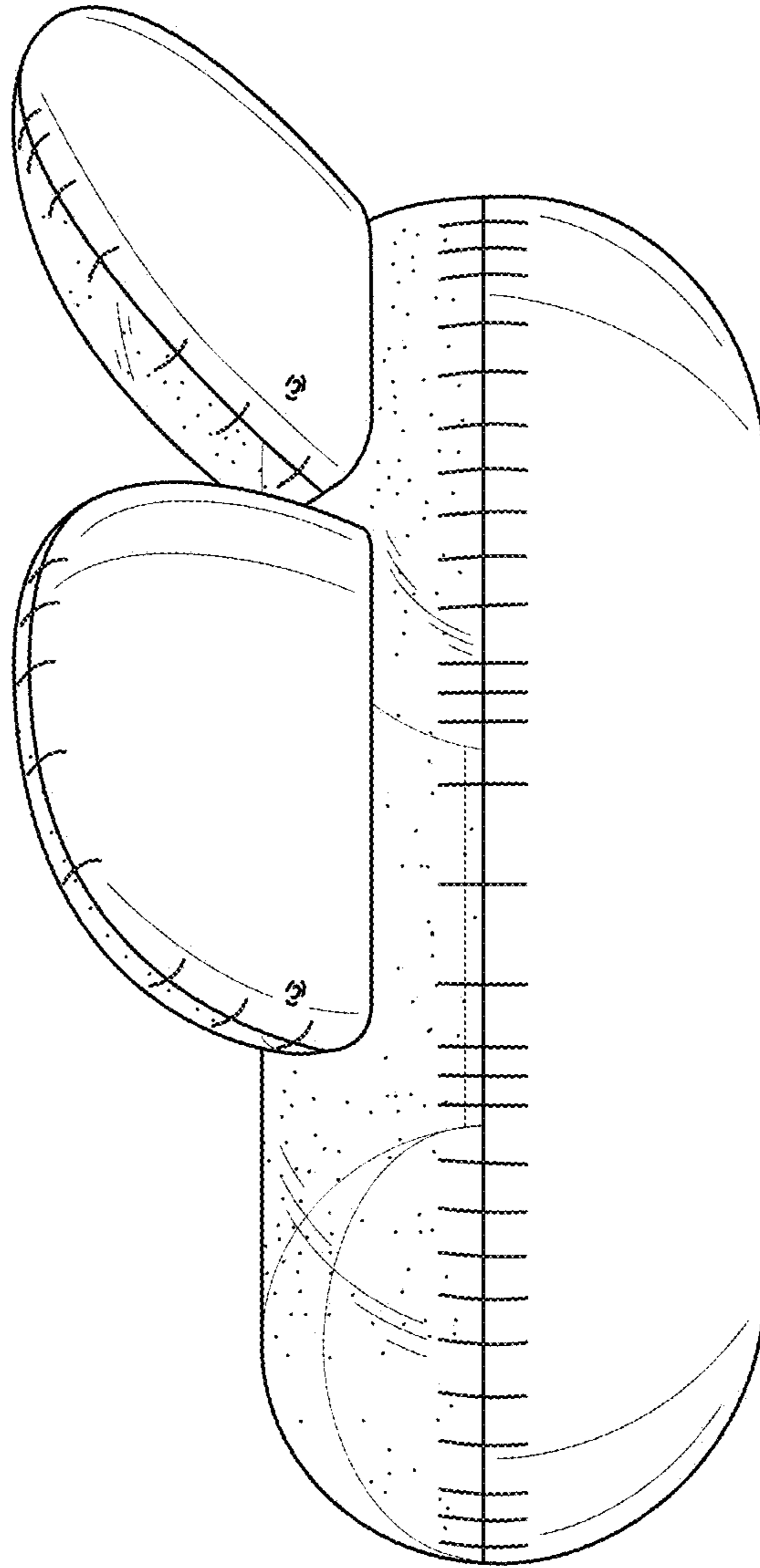

FIG. 5

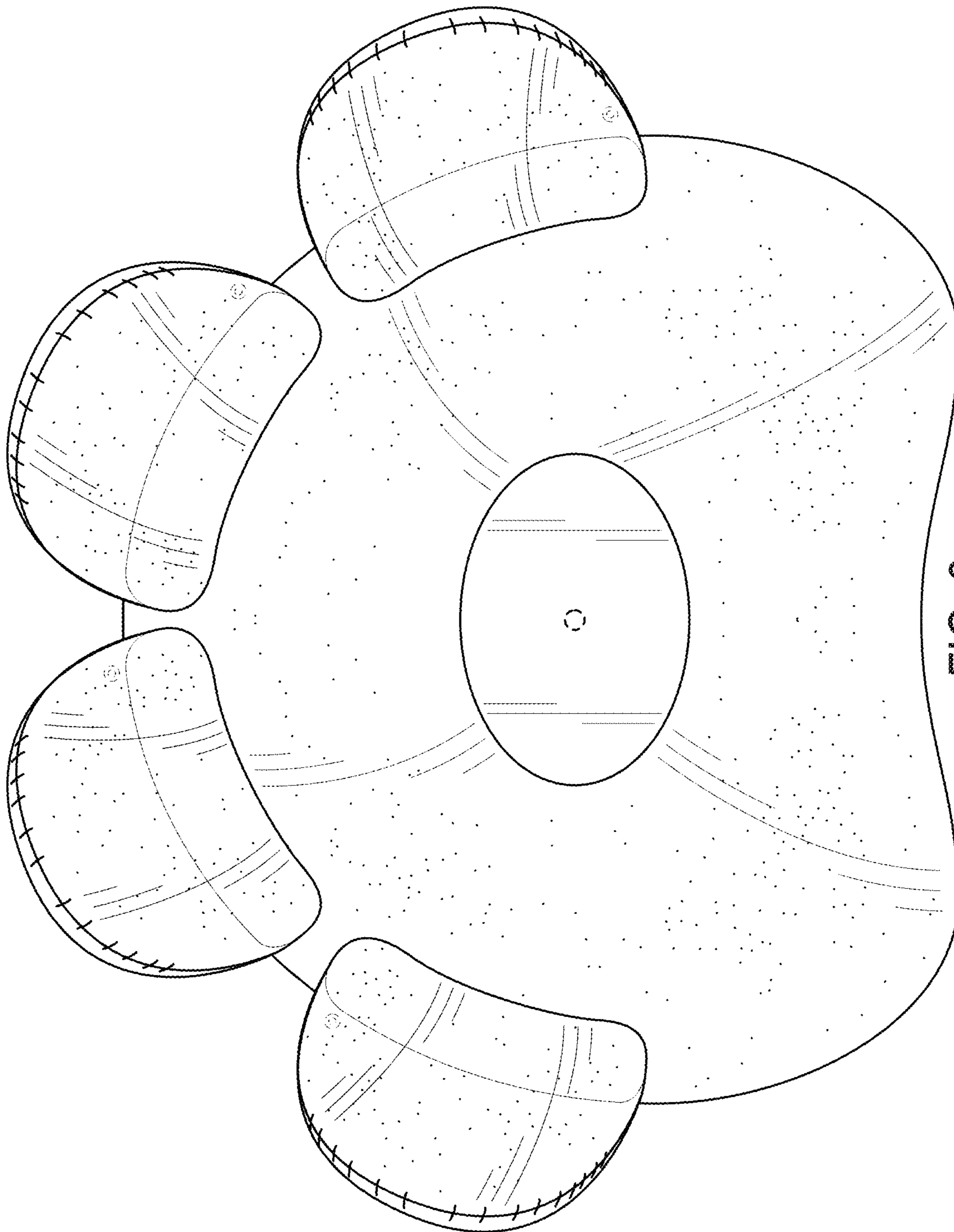

FIG. 6



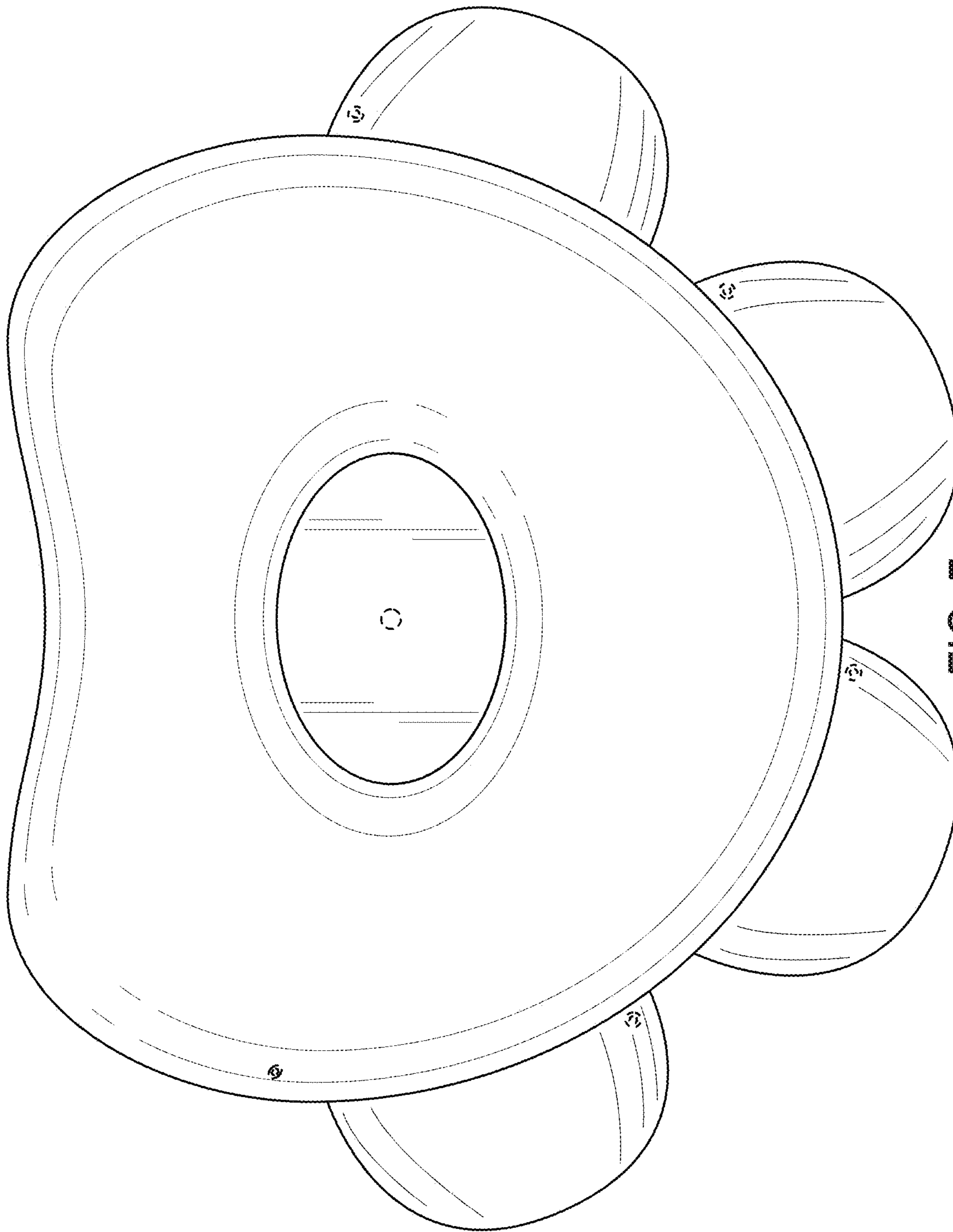

FIG. 7

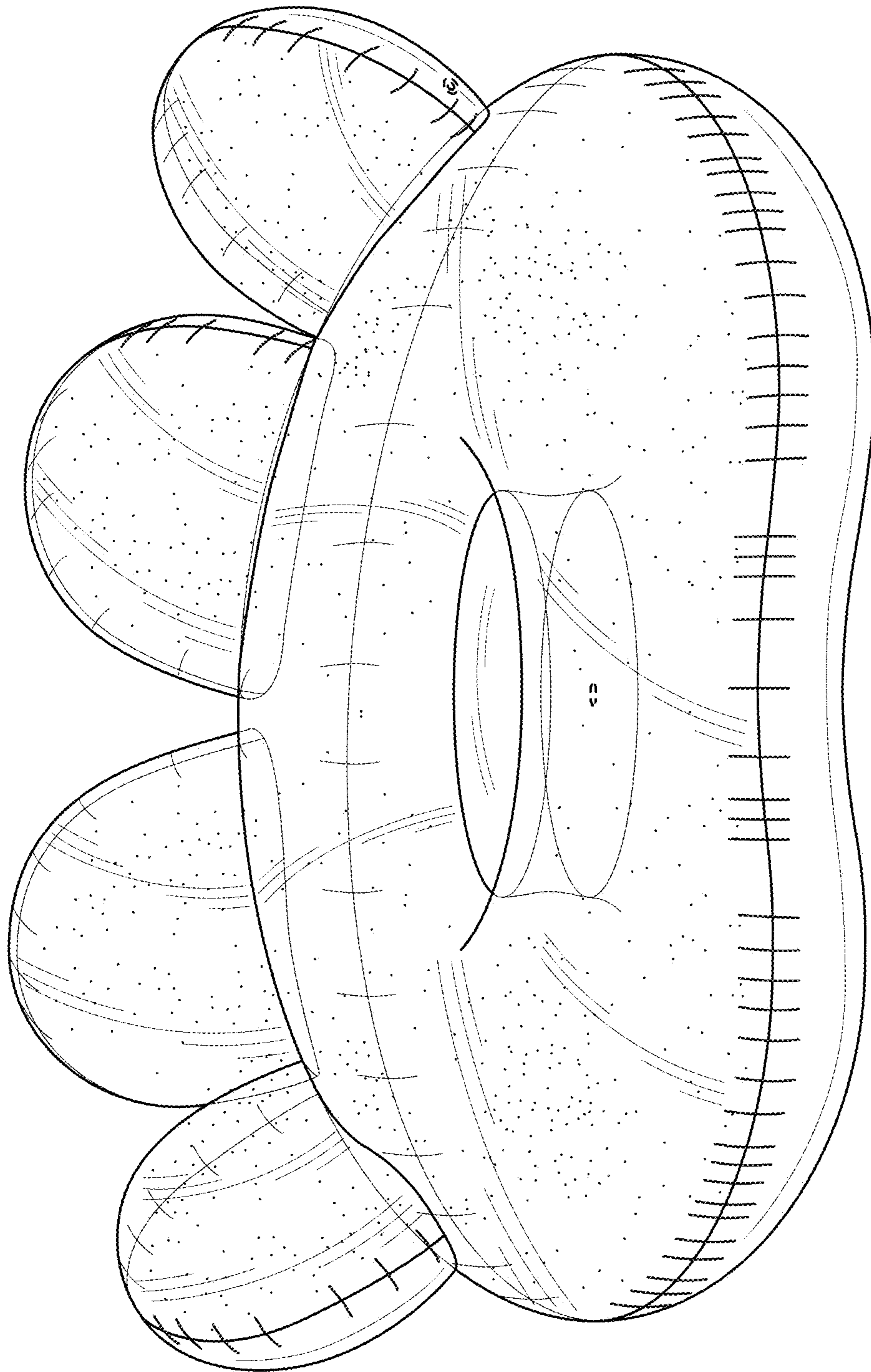

FIG. 8