



US00D927625S

(12) **United States Design Patent** (10) **Patent No.:** **US D927,625 S**
Liu (45) **Date of Patent:** **** Aug. 10, 2021**

(54) **GOLF KNIFE**
(71) Applicant: **Fuxiang Liu, Huili (CN)**
(72) Inventor: **Fuxiang Liu, Huili (CN)**
(**) Term: **15 Years**
(21) Appl. No.: **29/709,737**
(22) Filed: **Oct. 17, 2019**
(51) **LOC (13) Cl.** **21-02**
(52) **U.S. Cl.**
USPC **D21/793**
(58) **Field of Classification Search**
USPC D8/14, 51, 82, 83, 84, 85, 86, 88, 89,
D8/105, 107, 98, 99; D21/684, 793;
D26/49; D22/118, 117
CPC B25G 1/05; B25G 1/046; B25B 15/02;
B26B 15/04; B25F 1/02; B08B 1/01;
A63B 57/60; B63B 2210/58; B63B
2210/54
See application file for complete search history.

(56) **References Cited**
U.S. PATENT DOCUMENTS
1,250,328 A * 12/1917 Langford B25B 15/007
81/436
D190,333 S * 5/1961 Gunderson D4/118
D308,109 S * 5/1990 Maglica D26/49
D377,745 S * 2/1997 Laun D8/107
5,611,615 A * 3/1997 Jang A63B 29/08
362/109
5,638,566 A * 6/1997 Wu B25F 1/02
401/18
D407,289 S * 3/1999 Swenson, Jr. D8/82
D416,777 S * 11/1999 Swenson, Sr. D8/107
D455,511 S * 4/2002 Chang D26/46
D476,874 S * 7/2003 Kim D22/117
7,255,028 B1 * 8/2007 Di Bitonto B25B 15/02
81/439
D572,333 S * 7/2008 Heap D21/795

D645,718 S * 9/2011 Crystal D8/98
D653,722 S * 2/2012 Morris, Jr. D21/796
D653,927 S * 2/2012 Barnhart D8/89
D675,358 S * 1/2013 Brands D26/49
D704,368 S * 5/2014 Opolka D26/49
8,757,830 B2 * 6/2014 Gross F21V 33/0076
362/102
D736,975 S * 8/2015 Tang D26/38
D744,807 S * 12/2015 Hicks D8/98
D770,071 S * 10/2016 Windom D26/49
D856,447 S * 8/2019 Dunahay D21/684
D887,243 S * 6/2020 Su D8/85
D895,870 S * 9/2020 Huang D26/49
2008/0109976 A1 * 5/2008 Sanabia A63B 57/207
15/106

(Continued)

Primary Examiner — Philip S Hyder

(57) **CLAIM**

The ornamental design for a golf knife, as shown and described.

DESCRIPTION

FIG. 1 is a perspective view of a golf knife showing my new design;
FIG. 2 is a front view thereof;
FIG. 3 is a back view thereof;
FIG. 4 is a left side view thereof;
FIG. 5 is a right side view thereof;
FIG. 6 is a top view thereof;
FIG. 7 is a bottom view thereof;
FIG. 8 is a perspective view of an exploded state of the golf knife;
FIG. 9 is an enlarged view of the selected portion in FIG. 1; and,
FIG. 10 is an enlarged view of the selected portion in FIG. 2.
The broken lines shown in the drawings depict portions of the golf knife in which the design is embodied that form no part of the claimed design.

1 Claim, 10 Drawing Sheets

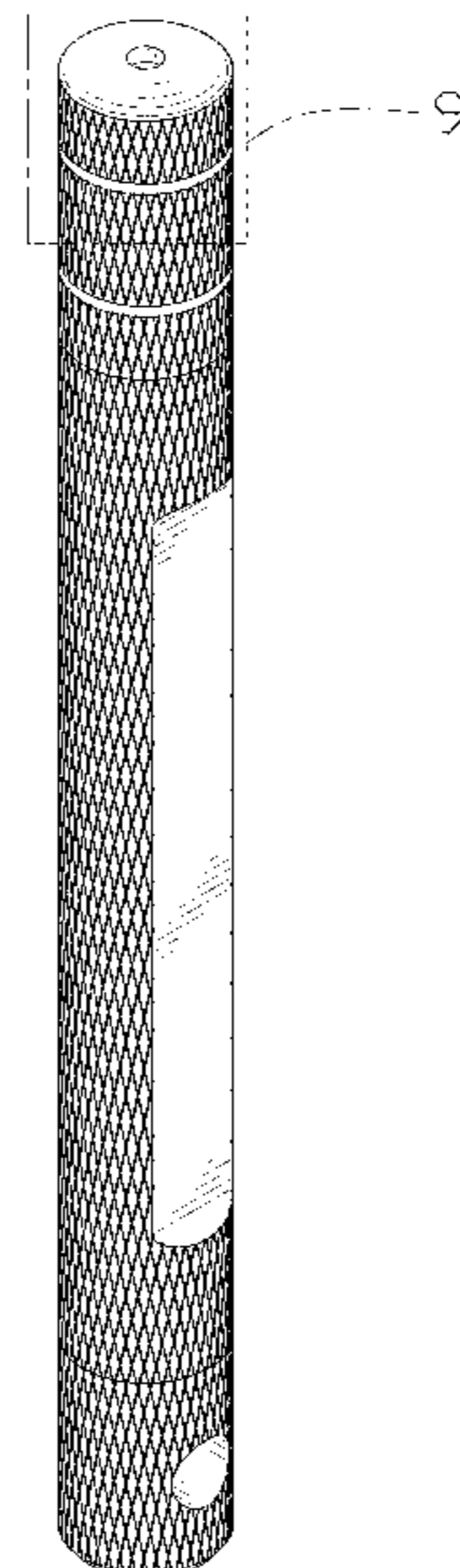

(56)

References Cited

U.S. PATENT DOCUMENTS

2010/0064467 A1* 3/2010 Lopes A63B 57/60
15/236.01
2012/0227198 A1* 9/2012 Blaszczyk A46B 5/0012
15/160
2017/0028445 A1* 2/2017 Lim B08B 1/00

* cited by examiner

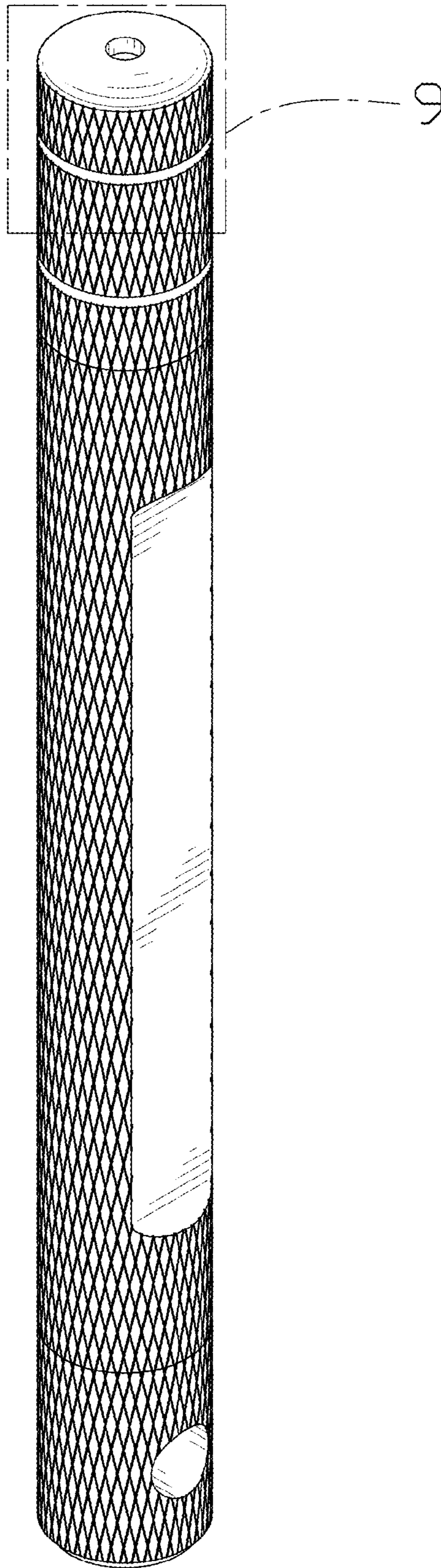

FIG. 1

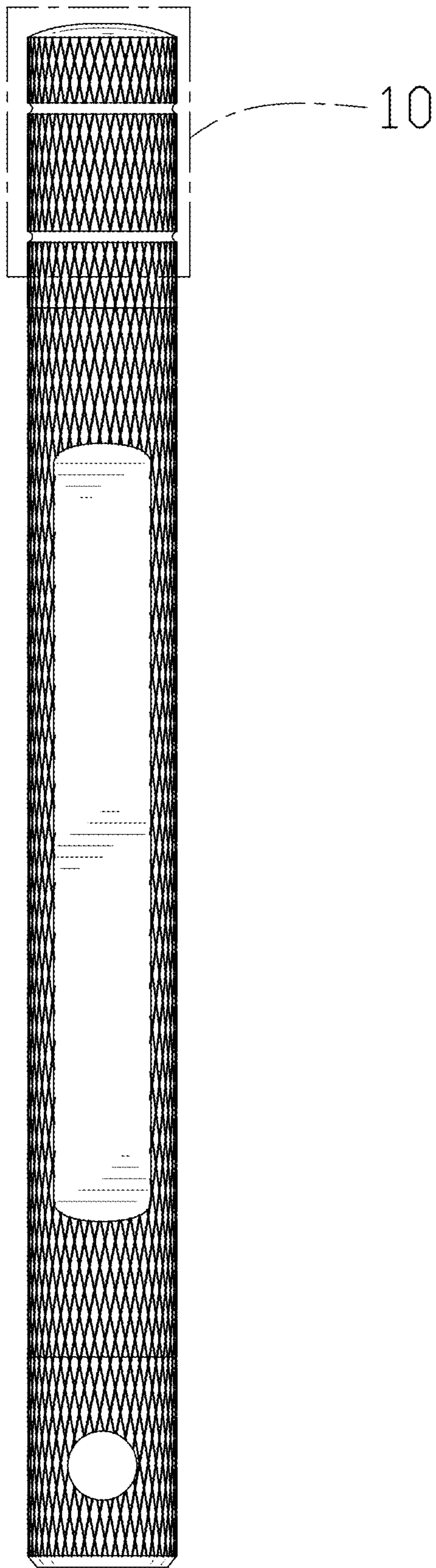

FIG. 2

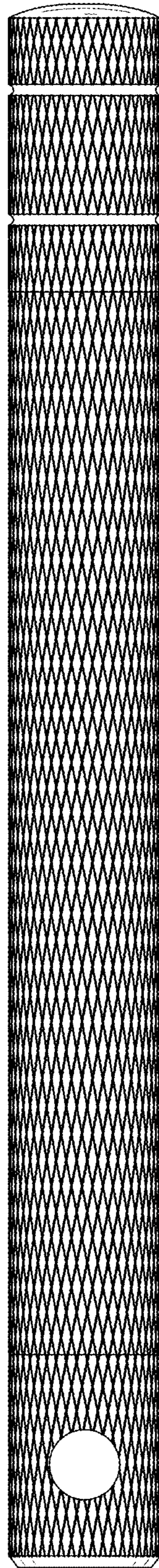

FIG. 3

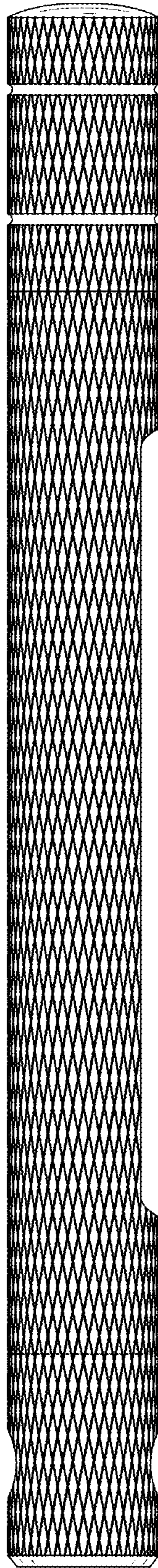

FIG. 4

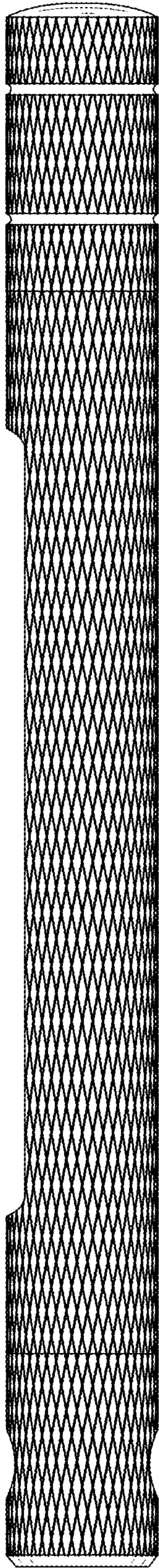

FIG. 5

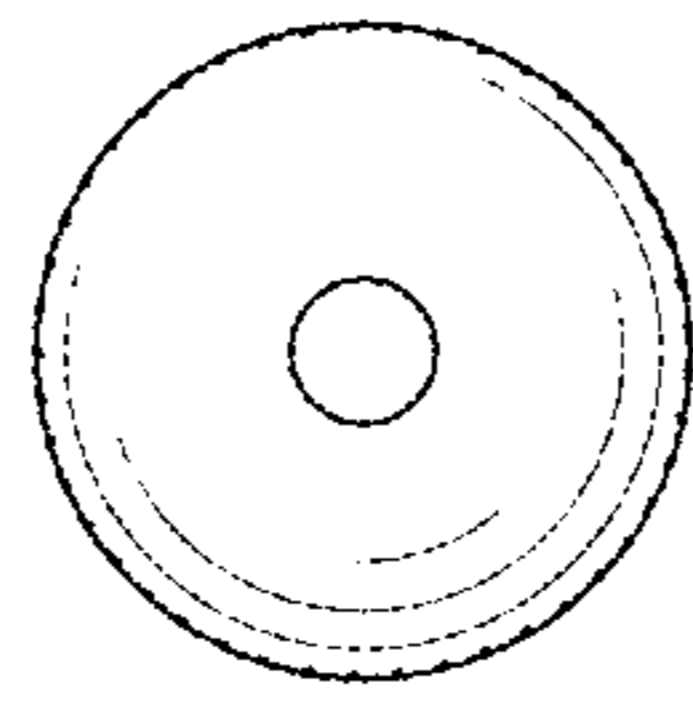

FIG. 6

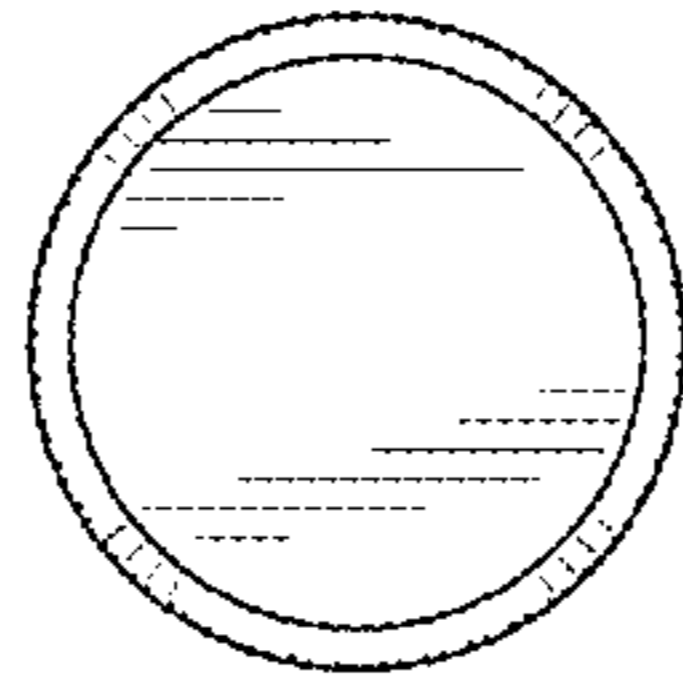

FIG. 7

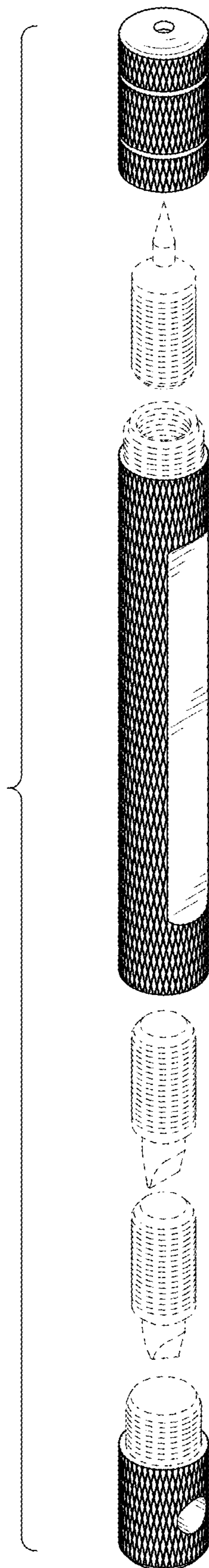

FIG. 8

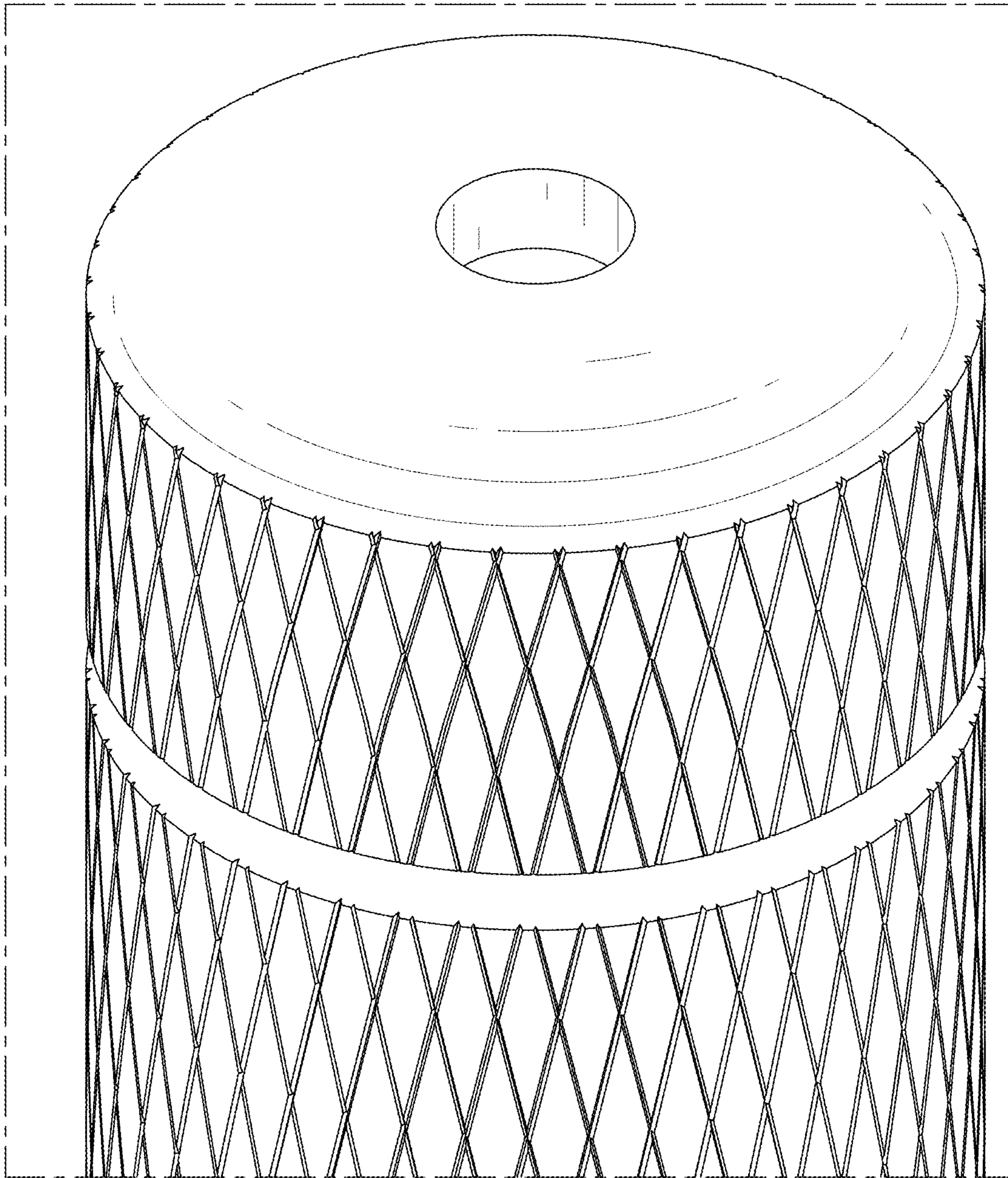

FIG. 9

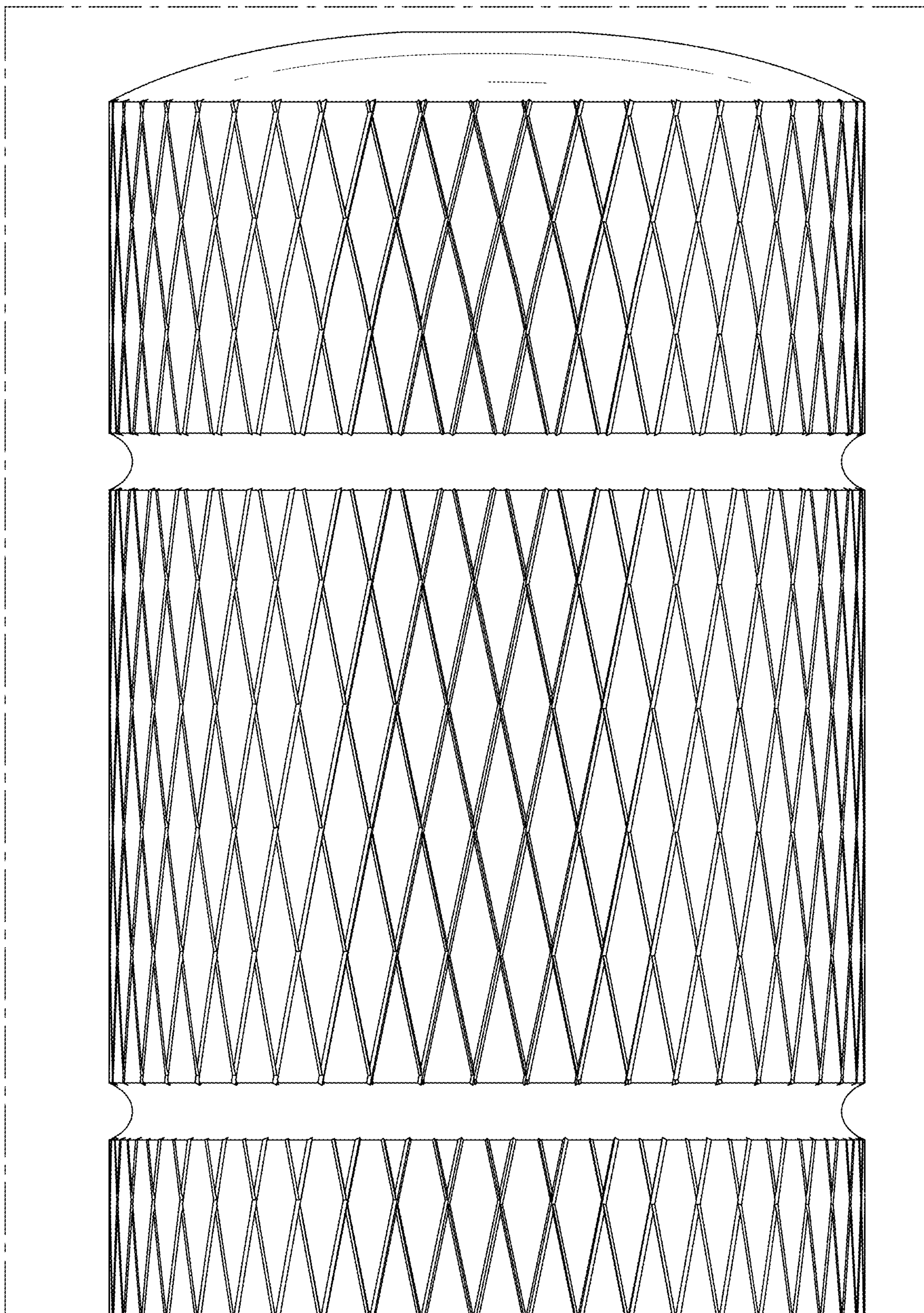

FIG. 10