



US00D927620S

(12) **United States Design Patent**
Nicolette et al.

(10) **Patent No.:** **US D927,620 S**
(45) **Date of Patent:** **** Aug. 10, 2021**

(54) **GOLF CLUB HEAD**

- (71) Applicant: **PARSONS XTREME GOLF, LLC**,
Scottsdale, AZ (US)
- (72) Inventors: **Michael R. Nicolette**, Scottsdale, AZ
(US); **Bradley D. Schweigert**, Cave
Creek, AZ (US)
- (73) Assignee: **PARSONS XTREME GOLF, LLC**,
Scottsdale, AZ (US)
- (**) Term: **15 Years**
- (21) Appl. No.: **29/712,736**
- (22) Filed: **Nov. 11, 2019**

Related U.S. Application Data

- (63) Continuation-in-part of application No. 29/700,964,
filed on Aug. 7, 2019, now abandoned, and a
continuation-in-part of application No. 29/695,080,
filed on Jun. 14, 2019, now abandoned.
- (51) **LOC (13) Cl.** **21-02**
- (52) **U.S. Cl.**
USPC **D21/747**
- (58) **Field of Classification Search**
USPC D21/747-751, 759
CPC A63B 53/00; A63B 53/02; A63B 53/04;
A63B 53/047; A63B 53/0475; A63B
(Continued)

(56) **References Cited**

U.S. PATENT DOCUMENTS

- 1,133,129 A 3/1915 Govan
 - D164,469 S 9/1951 Behrendt
 - 3,020,048 A 2/1962 Carroll
- (Continued)

OTHER PUBLICATIONS

International Search Report and Written Opinion Issued in connection with corresponding application No. PCT/US2015/016666, dated May 14, 2015 (7 Pages).

(Continued)

Primary Examiner — Mitchell I. Siegel

(57) **CLAIM**

The ornamental design for a golf club head, as shown and described.

DESCRIPTION

FIG. 1 is a top perspective view of a golf club head;
 FIG. 2 is a bottom perspective view of the golf club head of FIG. 1;
 FIG. 3 is a front elevational view of the golf club head of FIG. 1;
 FIG. 4 is a rear elevational view of the golf club head of FIG. 1;
 FIG. 5 is a top view of the golf club head of FIG. 1;
 FIG. 6 is a bottom view of the golf club head of FIG. 1;
 FIG. 7 is a left side view of the golf club head of FIG. 1;
 FIG. 8 is a right side view of the golf club head of FIG. 1;
 FIG. 9 is a top perspective view of a second embodiment of the golf club head;
 FIG. 10 is a bottom perspective view of the golf club head of FIG. 9;
 FIG. 11 is a front elevational view of the golf club head of FIG. 9;
 FIG. 12 is a rear elevational view of the golf club head of FIG. 9;
 FIG. 13 is a top view of the golf club head of FIG. 9;
 FIG. 14 is a bottom view of the golf club head of FIG. 9;
 FIG. 15 is a left side view of the golf club head of FIG. 9;
 and,
 FIG. 16 is a right side view of the golf club head of FIG. 9.
 The broken lines shown form no part of the claimed design.

1 Claim, 8 Drawing Sheets

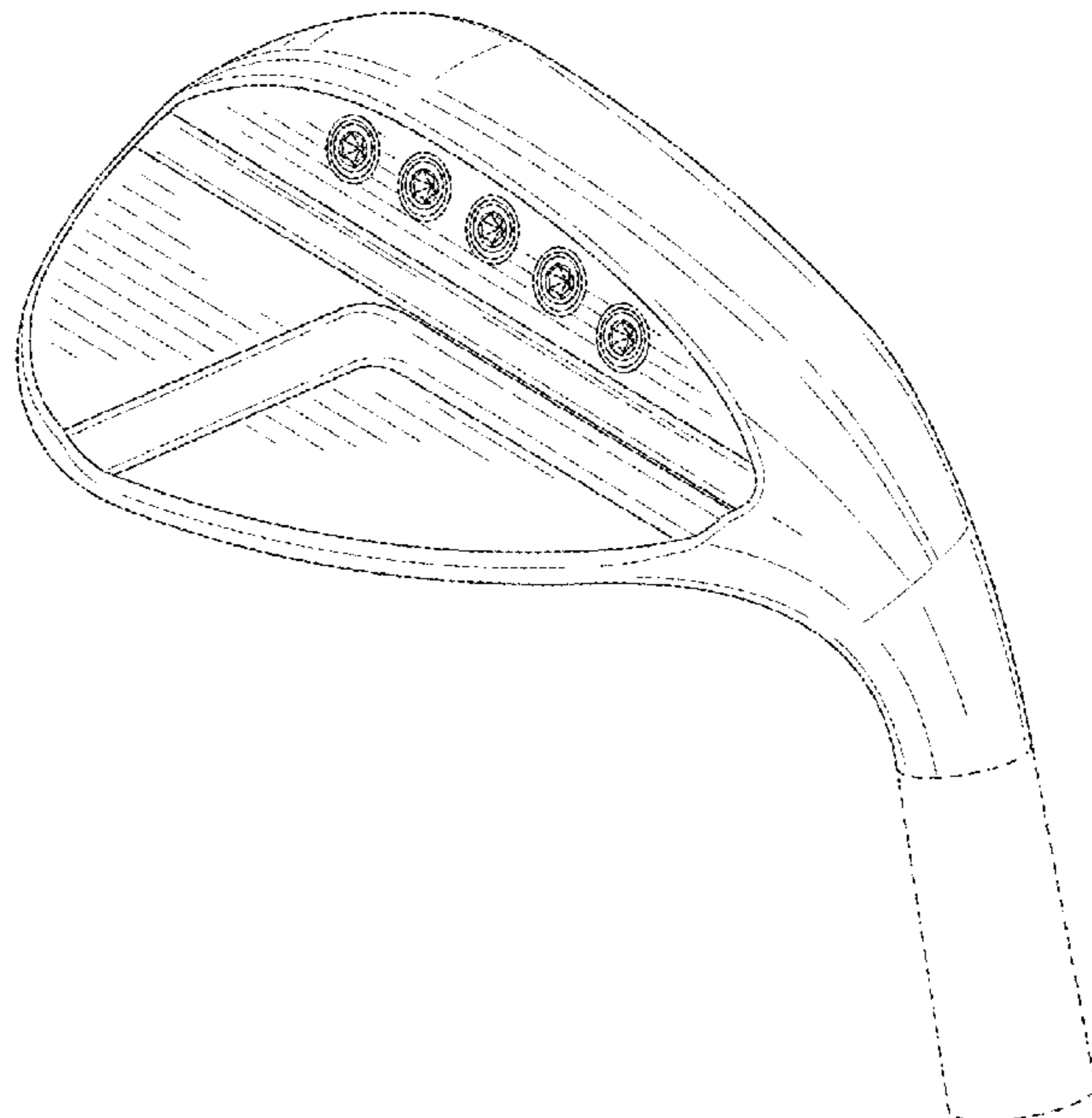
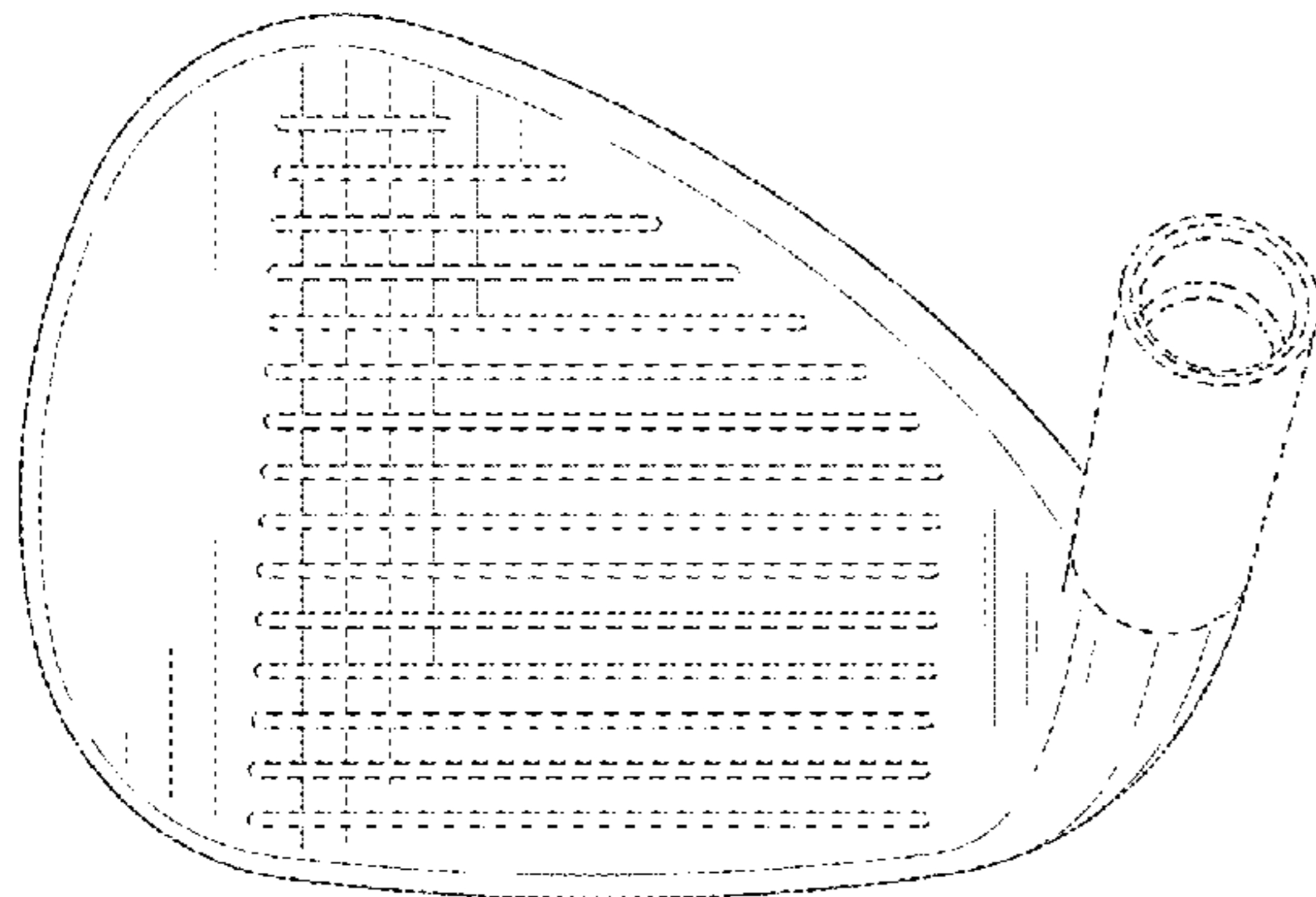

(58) **Field of Classification Search**
 CPC 2053/0479; A63B 2053/0483; A63B
 2053/0445; A63B 60/00; A63B 60/46
 See application file for complete search history.

(56) **References Cited**
 U.S. PATENT DOCUMENTS

D203,936 S 3/1966 Long
 D215,101 S 9/1969 Sabat
 D234,963 S 4/1975 Hirata
 D239,550 S 4/1976 Timbrook
 D240,054 S 5/1976 Meissler
 D244,792 S 6/1977 Gelinas
 D250,136 S 10/1978 Gelinas
 D261,167 S 10/1981 Swanson
 D294,617 S * 3/1988 Perkins D21/749
 4,754,977 A * 7/1988 Sahm A63B 53/047
 473/337
 4,824,116 A 4/1989 Nagamoto
 4,988,104 A 1/1991 Shiotani
 5,158,296 A * 10/1992 Lee A63B 53/04
 473/327
 5,176,384 A 1/1993 Sata
 5,213,328 A 5/1993 Long
 D336,672 S 6/1993 Gorman
 D353,862 S 12/1994 Saito
 D357,520 S 4/1995 Schmidt
 5,419,560 A 5/1995 Bamber
 5,425,535 A 6/1995 Gee
 D361,358 S 8/1995 Simmons
 5,447,311 A 9/1995 Viollaz
 5,451,056 A 9/1995 Manning
 D362,884 S 10/1995 Sheeley
 D362,885 S 10/1995 Sheeley
 D362,887 S 10/1995 Sheeley
 D370,514 S 6/1996 Sheeley
 5,540,437 A 7/1996 Bamber
 D379,106 S 5/1997 Maltby
 5,637,045 A 6/1997 Igarashi
 5,669,830 A 9/1997 Bamber
 D389,540 S 1/1998 Mendenhall
 D389,541 S 1/1998 Huan-Chiang
 D395,476 S 6/1998 Pond et al.
 5,766,091 A 6/1998 Humphrey
 5,766,092 A 6/1998 Mimeur
 D399,277 S 10/1998 Ezaki
 5,827,132 A 10/1998 Bamber
 D408,485 S 4/1999 Kenji
 5,899,821 A 5/1999 Hsu
 5,935,016 A 8/1999 Antonious
 D414,535 S 9/1999 Mertens
 D421,080 S * 2/2000 Chen D21/747
 D426,276 S 6/2000 Besnard et al.
 D426,476 S 6/2000 Goss
 6,077,171 A * 6/2000 Yoneyama A63B 60/00
 473/291
 D442,659 S 5/2001 Solheim
 D443,008 S 5/2001 Kubica
 D445,862 S 7/2001 Ford
 6,290,609 B1 9/2001 Takeda
 D449,866 S 10/2001 Miller
 D457,211 S 5/2002 Bakke
 D458,328 S 6/2002 Solheim
 D469,833 S 2/2003 Roberts
 D473,605 S 4/2003 Petersen
 D475,107 S 5/2003 Madore
 D476,048 S 6/2003 Cleveland
 D478,949 S 8/2003 De La Cruz
 6,638,182 B2 10/2003 Kosmatka
 6,695,714 B1 2/2004 Bliss
 6,702,693 B2 3/2004 Bamber
 D488,201 S 4/2004 Wahl
 D492,376 S 6/2004 Schweigert
 D494,240 S 8/2004 Schweigert
 D494,648 S 8/2004 Schweigert
 6,780,123 B2 8/2004 Hasebe

D497,963 S 11/2004 Toulon
 6,811,496 B2 11/2004 Wahl
 D499,779 S 12/2004 Mahaffey
 D500,350 S 12/2004 Schweigert
 D500,351 S 12/2004 Schweigert
 D502,237 S 2/2005 Schweigert
 D502,975 S 3/2005 Schweigert
 D503,204 S 3/2005 Nicolette et al.
 D504,925 S 5/2005 Schweigert
 D505,171 S 5/2005 Solheim
 D507,320 S 7/2005 Roberts et al.
 D507,614 S 7/2005 Schweigert
 D508,099 S 8/2005 Solheim
 D508,545 S 8/2005 Roberts et al.
 6,923,733 B2 8/2005 Chen
 D514,183 S 1/2006 Schweigert
 D516,650 S 3/2006 Stone
 D518,863 S 4/2006 Masafumi
 D523,501 S 6/2006 Schweigert
 D523,917 S 6/2006 Roberts
 D524,889 S 7/2006 Kim
 D530,759 S 10/2006 Solheim
 D530,760 S 10/2006 Solheim
 7,121,956 B2 * 10/2006 Lo A63B 53/0466
 473/335
 7,128,663 B2 10/2006 Bamber
 D531,688 S 11/2006 Wahl
 D532,849 S 11/2006 Solheim
 D534,228 S 12/2006 Solheim
 D534,595 S * 1/2007 Hasebe D21/747
 D534,597 S 1/2007 Solheim
 7,156,751 B2 1/2007 Wahl
 D536,759 S 2/2007 Nicolette
 D537,494 S 2/2007 Solheim
 7,182,698 B2 2/2007 Tseng
 D538,366 S 3/2007 Nicolette
 D539,864 S 4/2007 Solheim
 D540,898 S 4/2007 Solheim
 D541,360 S 4/2007 Solheim
 7,207,900 B2 4/2007 Nicolette
 D543,601 S * 5/2007 Kawami D21/759
 D544,056 S 6/2007 Solheim
 D547,410 S 7/2007 Solheim
 D555,219 S * 11/2007 Lin D21/759
 7,303,486 B2 12/2007 Imamoto
 D559,932 S 1/2008 Belmont
 D561,855 S 2/2008 Nicolette
 D562,925 S 2/2008 Nicolette
 7,351,164 B2 4/2008 Schweigert
 D570,435 S 6/2008 Sanchez
 D570,935 S 6/2008 Nicolette
 D570,936 S 6/2008 Nicolette
 D570,942 S 6/2008 Schweigert
 D571,422 S 6/2008 Nicolette
 D571,425 S 6/2008 Nicolette
 D571,427 S 6/2008 Schweigert
 D571,881 S 6/2008 Solheim
 D572,326 S 7/2008 Schweigert
 D572,329 S 7/2008 Solheim
 D573,219 S 7/2008 Schweigert
 7,396,299 B2 7/2008 Nicolette
 7,413,518 B2 8/2008 Cole
 D577,783 S 9/2008 Nicolette
 D578,590 S 10/2008 Nicolette
 D581,000 S 11/2008 Sanchez
 D581,004 S 11/2008 Chen
 D584,370 S 1/2009 Cleveland
 D585,103 S 1/2009 Tang
 D586,414 S 2/2009 Tang
 D587,327 S 2/2009 Wahl
 D594,518 S 6/2009 Schweigert
 D596,256 S 7/2009 Nicolette
 D596,257 S 7/2009 Nicolette
 D596,258 S 7/2009 Jertson
 D596,688 S 7/2009 Chen
 D597,158 S 7/2009 Nicolette
 D601,216 S 9/2009 Nicolette
 7,588,502 B2 9/2009 Nishino
 7,601,075 B2 10/2009 Cole

(56)

References Cited

U.S. PATENT DOCUMENTS

D604,783 S 11/2009 Solheim
 7,611,424 B2 11/2009 Nagai
 D606,605 S 12/2009 Ban
 D607,070 S 12/2009 Ban
 D607,071 S 12/2009 Ban
 7,658,686 B2 2/2010 Soracco
 D612,438 S 3/2010 Carlyle
 D612,439 S 3/2010 Carlyle
 D617,406 S 6/2010 Carlyle
 D618,293 S 6/2010 Foster et al.
 7,736,243 B2 6/2010 Sanchez
 7,744,484 B1 6/2010 Chao
 D621,893 S 8/2010 Nicolette
 D621,894 S 8/2010 Schweigert
 D621,895 S 8/2010 Schweigert
 7,798,917 B2 9/2010 Nguyen
 7,815,521 B2 10/2010 Ban
 D627,409 S 11/2010 Schweigert
 D627,410 S 11/2010 Nicolette et al.
 7,846,040 B2 12/2010 Ban
 D633,159 S 2/2011 Manwaring
 D633,967 S 3/2011 Carlyle
 D635,627 S 4/2011 Nicolette
 7,938,738 B2 5/2011 Roach
 D642,642 S 8/2011 Schweigert
 D643,488 S 8/2011 Manwaring
 D643,490 S 8/2011 Ban
 D643,491 S 8/2011 Solheim
 D643,492 S 8/2011 Nicolette
 D643,895 S 8/2011 Wieland
 D643,896 S 8/2011 Schweigert
 D647,582 S 10/2011 Nicolette
 D649,211 S 11/2011 Schweigert
 8,062,150 B2 11/2011 Gilbert
 D651,268 S 12/2011 Nicolette
 8,088,025 B2 1/2012 Wahl
 8,092,319 B1 1/2012 Cackett
 8,105,180 B1 1/2012 Cackett
 8,142,307 B2 3/2012 Sanchez
 D658,248 S 4/2012 Toulon
 8,221,262 B1 7/2012 Cackett
 8,246,487 B1 8/2012 Cackett
 D670,775 S 11/2012 Schweigert
 D672,417 S 12/2012 Schweigert
 8,328,662 B2 12/2012 Nakamura
 D673,633 S 1/2013 Schweigert
 D673,634 S 1/2013 Schweigert
 8,376,878 B2 2/2013 Bennett
 D680,603 S 4/2013 Nicolette
 D681,142 S 4/2013 Fossum et al.
 D681,143 S 4/2013 Nicolette
 8,414,422 B2 4/2013 Peralta
 8,506,420 B2 8/2013 Hocknell
 8,545,343 B2 10/2013 Boyd
 8,574,094 B2 11/2013 Nicolette
 8,657,700 B2 2/2014 Nicolette
 8,663,026 B2 3/2014 Blowers
 8,690,710 B2 4/2014 Nicolette
 D707,316 S 6/2014 Brunski
 D707,317 S 6/2014 Brunski
 8,753,230 B2 6/2014 Stokke
 D708,688 S 7/2014 Nicolette
 8,827,832 B2 9/2014 Breier
 8,827,833 B2 9/2014 Amano
 8,845,455 B2 9/2014 Ban
 D716,387 S 10/2014 Brunski
 D716,388 S 10/2014 Brunski
 D716,391 S 10/2014 Wee
 D722,352 S * 2/2015 Nicolette D21/747
 D723,120 S * 2/2015 Nicolette D21/747
 8,961,336 B1 * 2/2015 Parsons A63B 53/0475
 473/332
 D726,265 S * 4/2015 Nicolette D21/747
 9,199,143 B1 12/2015 Parsons
 D746,926 S * 1/2016 Parsons D21/747

D748,214 S * 1/2016 Nicolette D21/747
 D748,749 S * 2/2016 Nicolette D21/759
 D751,660 S * 3/2016 Greenlaw D21/759
 D756,471 S * 5/2016 Nicolette D21/747
 D764,610 S * 8/2016 Parsons D21/747
 9,421,437 B2 8/2016 Parsons
 9,427,634 B2 8/2016 Parsons
 D765,809 S * 9/2016 Peterson D21/759
 D767,057 S * 9/2016 Mickelson D21/747
 D773,575 S * 12/2016 Nicolette D21/747
 D802,068 S * 11/2017 Parsons D21/747
 D816,787 S * 5/2018 Nicolette D21/747
 D817,422 S * 5/2018 Noyes D21/759
 D825,891 S * 8/2018 Parsons D2/747
 D827,065 S * 8/2018 Nicolette D21/747
 D835,737 S * 12/2018 Parsons D21/747
 D852,302 S * 6/2019 Parsons D21/747
 D863,478 S * 10/2019 Parsons D21/747
 D864,326 S * 10/2019 Mickelson D21/747
 D893,647 S * 8/2020 Parsons D21/747
 D893,648 S * 8/2020 Parsons D21/747
 D894,302 S * 8/2020 Parsons D21/747
 10,729,948 B2 * 8/2020 Parsons A63B 53/047
 D898,143 S * 10/2020 Parsons D21/747
 D898,144 S * 10/2020 Parsons D21/747
 D898,145 S * 10/2020 Parsons D21/747
 2002/0107087 A1 8/2002 Fagot
 2003/0139226 A1 7/2003 Cheng
 2003/0176231 A1 9/2003 Hasebe
 2004/0204263 A1 10/2004 Fagot
 2005/0009632 A1 1/2005 Schweigert
 2005/0014573 A1 1/2005 Lee
 2005/0096148 A1 5/2005 Noble
 2005/0119066 A1 6/2005 Stites
 2005/0239569 A1 10/2005 Best
 2005/0277485 A1 * 12/2005 Hou A63B 60/54
 473/332
 2006/0111200 A1 5/2006 Poynor
 2007/0032308 A1 2/2007 Fagot
 2007/0225084 A1 9/2007 Schweigert
 2008/0058113 A1 3/2008 Nicolette
 2008/0188322 A1 8/2008 Anderson
 2008/0300065 A1 12/2008 Schweigert
 2009/0029790 A1 1/2009 Nicolette
 2010/0130306 A1 5/2010 Schweigert
 2010/0178999 A1 7/2010 Nicolette
 2011/0111683 A1 5/2011 Kelnhofer
 2011/0165963 A1 7/2011 Cackett
 2011/0269567 A1 11/2011 Ban
 2011/0294596 A1 12/2011 Ban
 2012/0267410 A1 10/2012 Loudenslager
 2013/0137532 A1 5/2013 Deshmukh
 2013/0225319 A1 8/2013 Kato
 2013/0281226 A1 10/2013 Ban
 2013/0288823 A1 10/2013 Hebreo
 2013/0303303 A1 11/2013 Ban
 2013/0310192 A1 11/2013 Wahl
 2014/0080621 A1 3/2014 Nicolette
 2014/0128175 A1 5/2014 Jertson
 2014/0274441 A1 9/2014 Greer
 2014/0274451 A1 9/2014 Knight
 2015/0136825 A1 5/2015 Kalck
 2015/0231454 A1 * 8/2015 Parsons A63B 53/06
 473/335
 2015/0231806 A1 * 8/2015 Parsons B29C 45/14467
 264/261

OTHER PUBLICATIONS

Kozuchowski, Zak, "Callaway Mack Daddy 2 PM Grind Wedges" (<http://golfwrz.com/276203/callaway-mack-daddy-2-pm-grind-wedges/>), www.golfwrz.com, Golfwrz Holdings, LLC, Published Jan. 21, 2015.
 Wall, Jonathan, "Details: Phil's Prototype Mack Daddy PM-Grind Wedge," (<http://www.pgatour.com/equipmentreport/2015/01/21/>)

(56)

References Cited

OTHER PUBLICATIONS

callaway-wedge.html),www.pgatour.com, PGA Tour, Inc., Published Jan. 21, 2015.

* cited by examiner

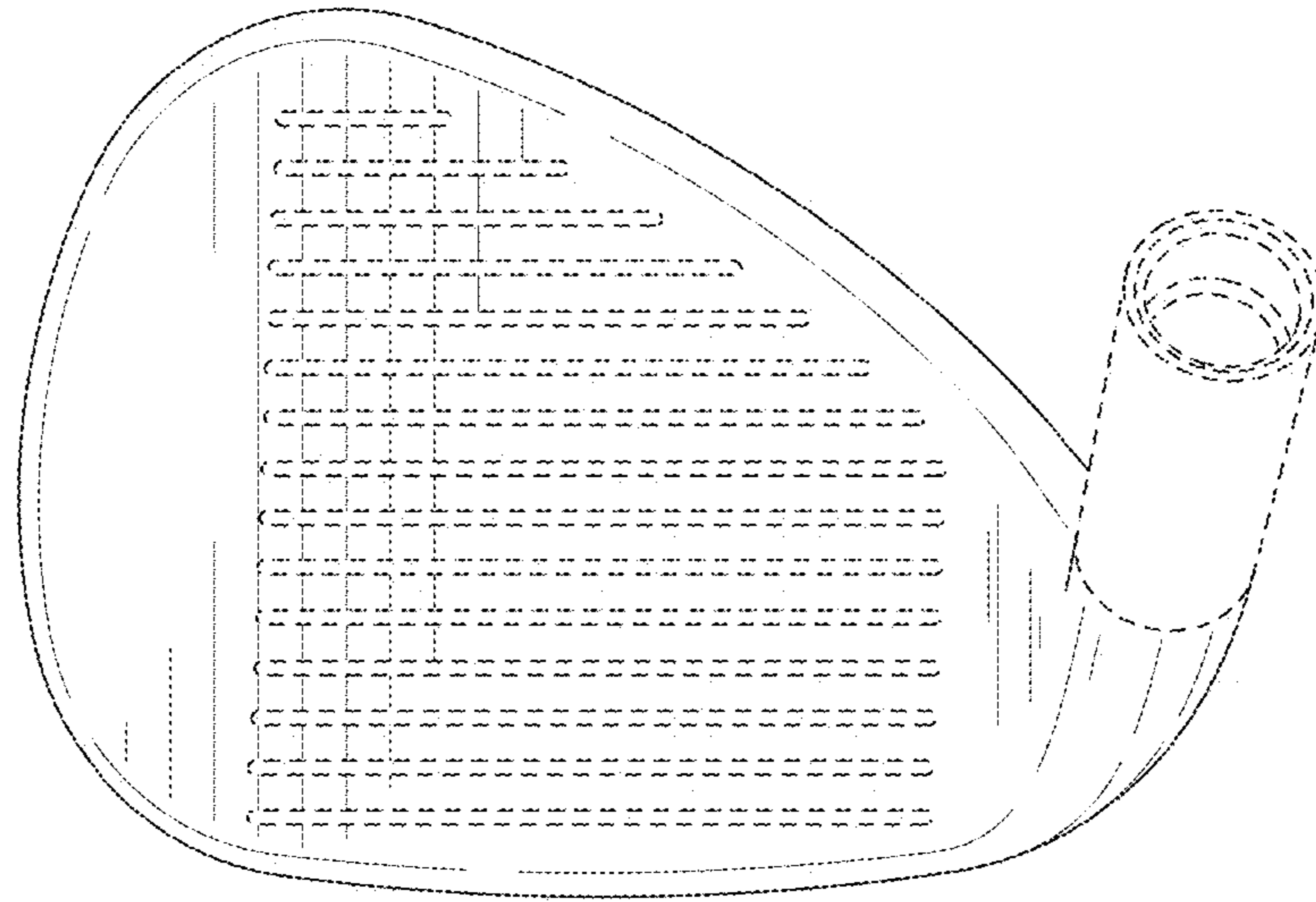

FIG. 1

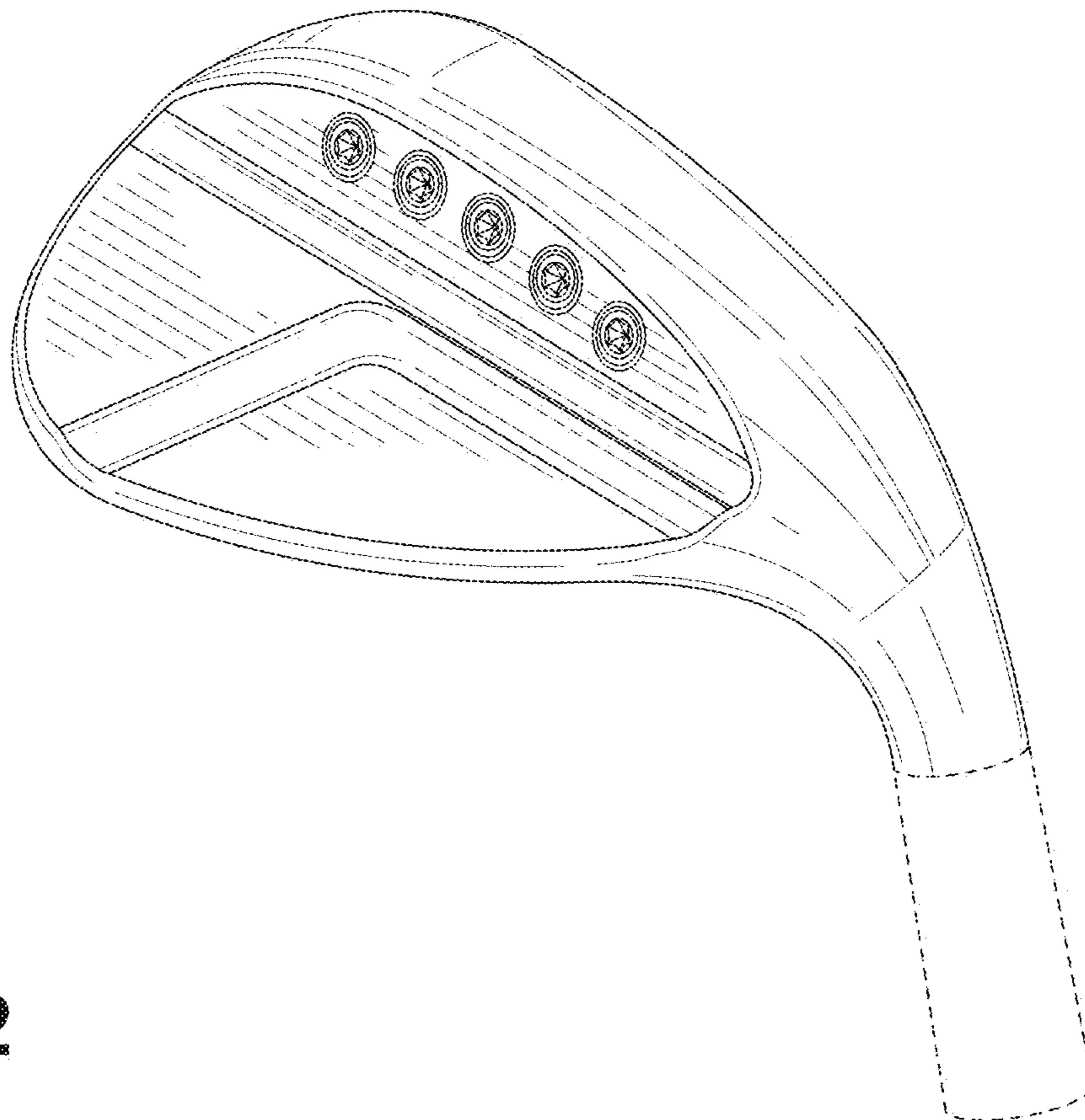

FIG. 2

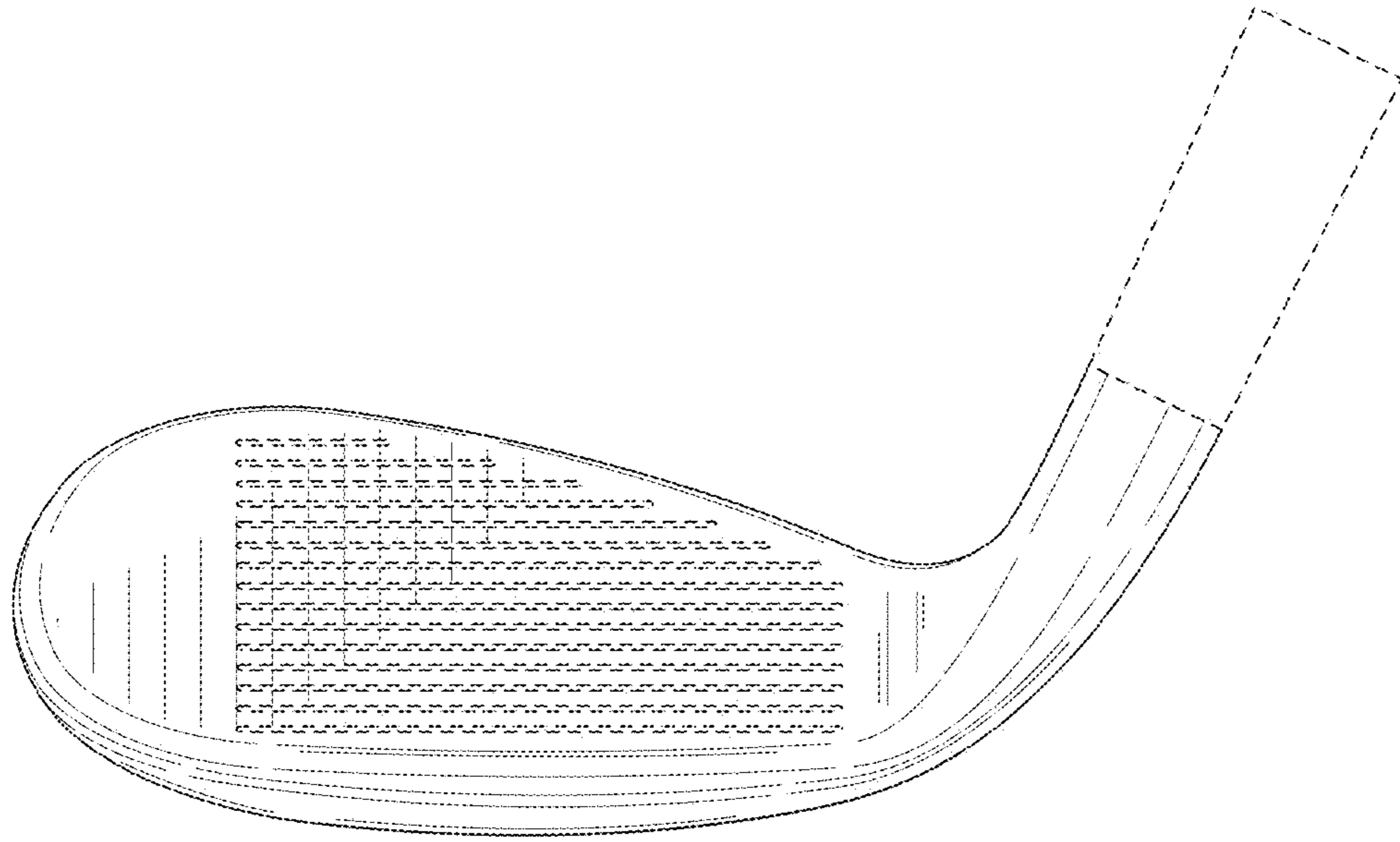

FIG. 3

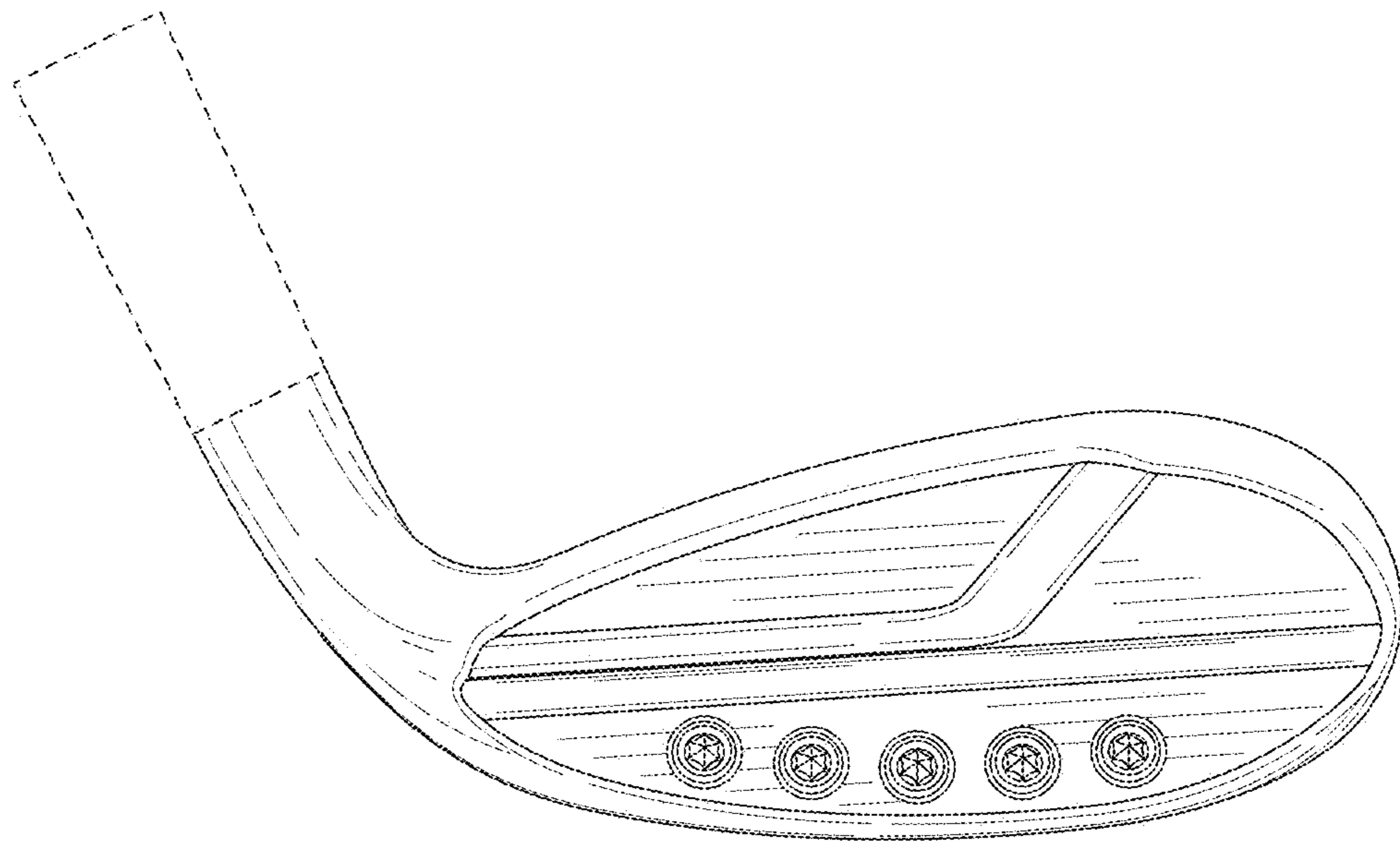

FIG. 4

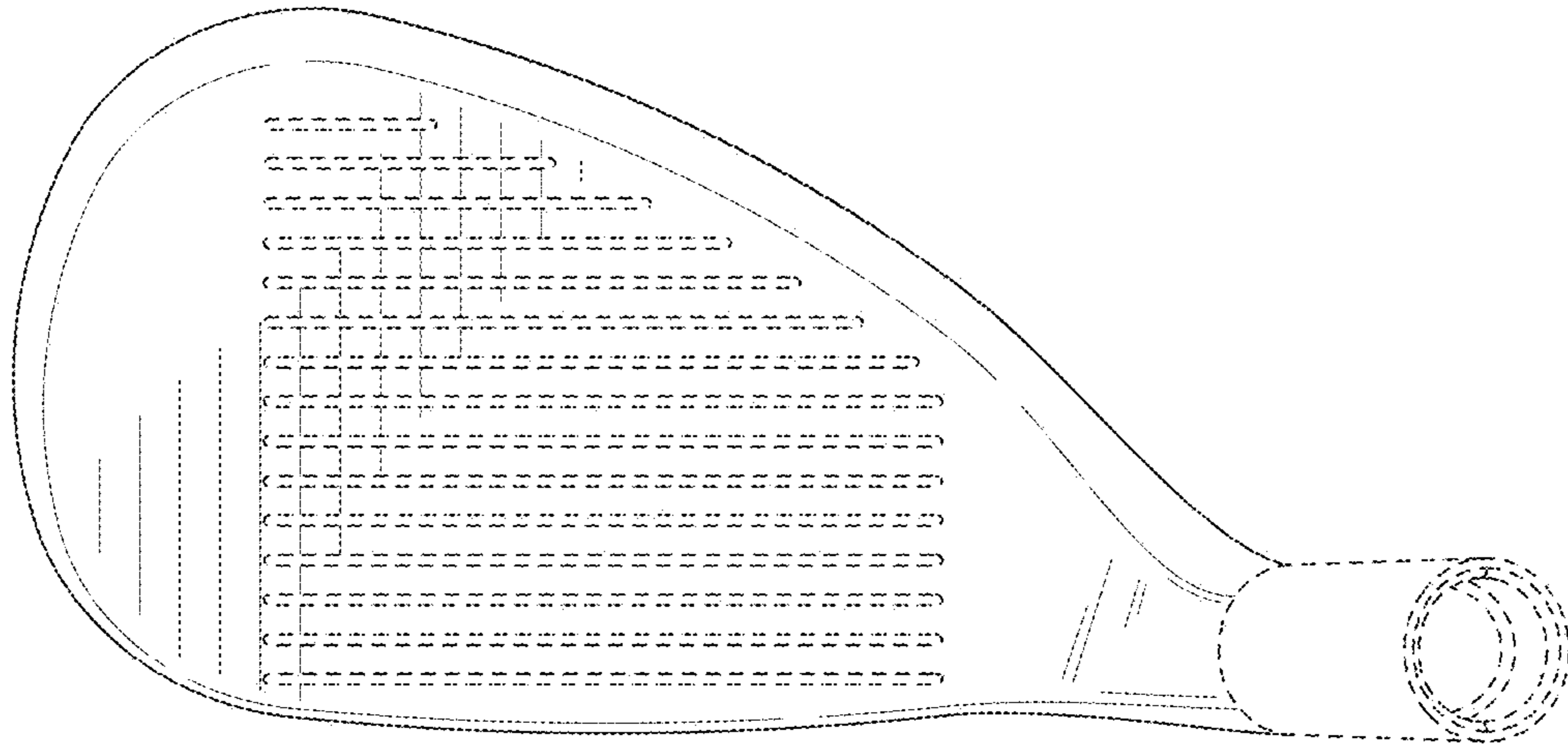

FIG. 5

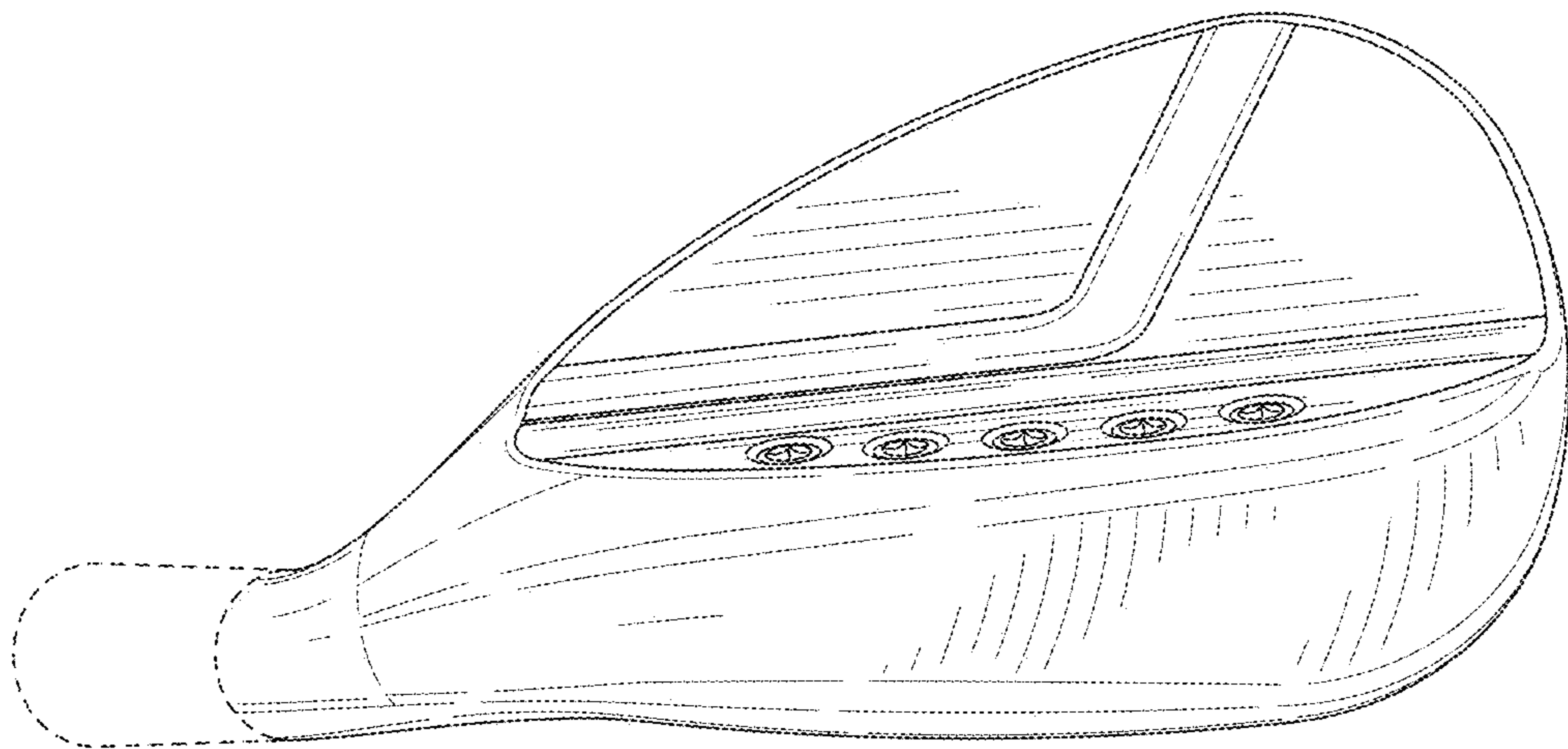

FIG. 6

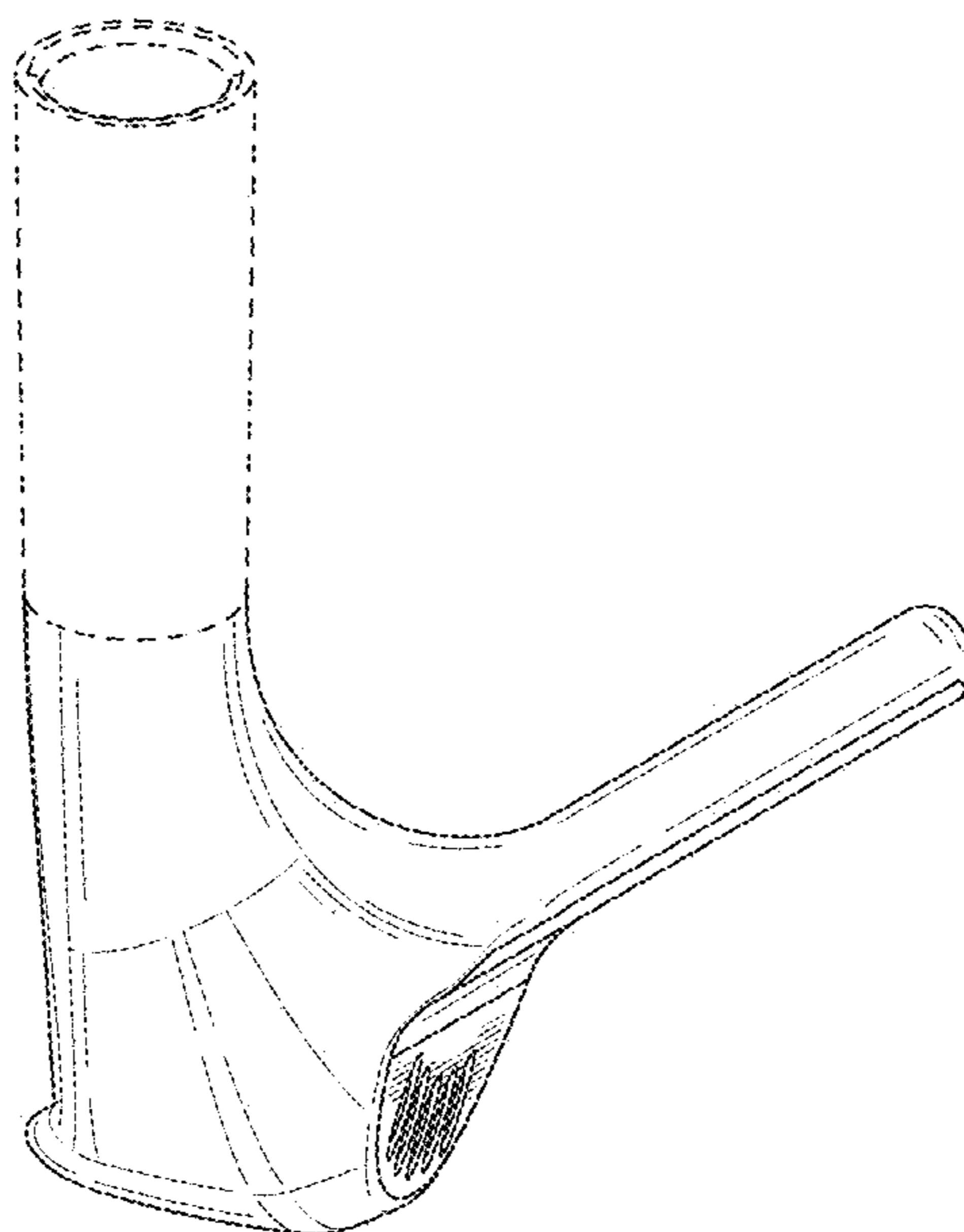

FIG. 7

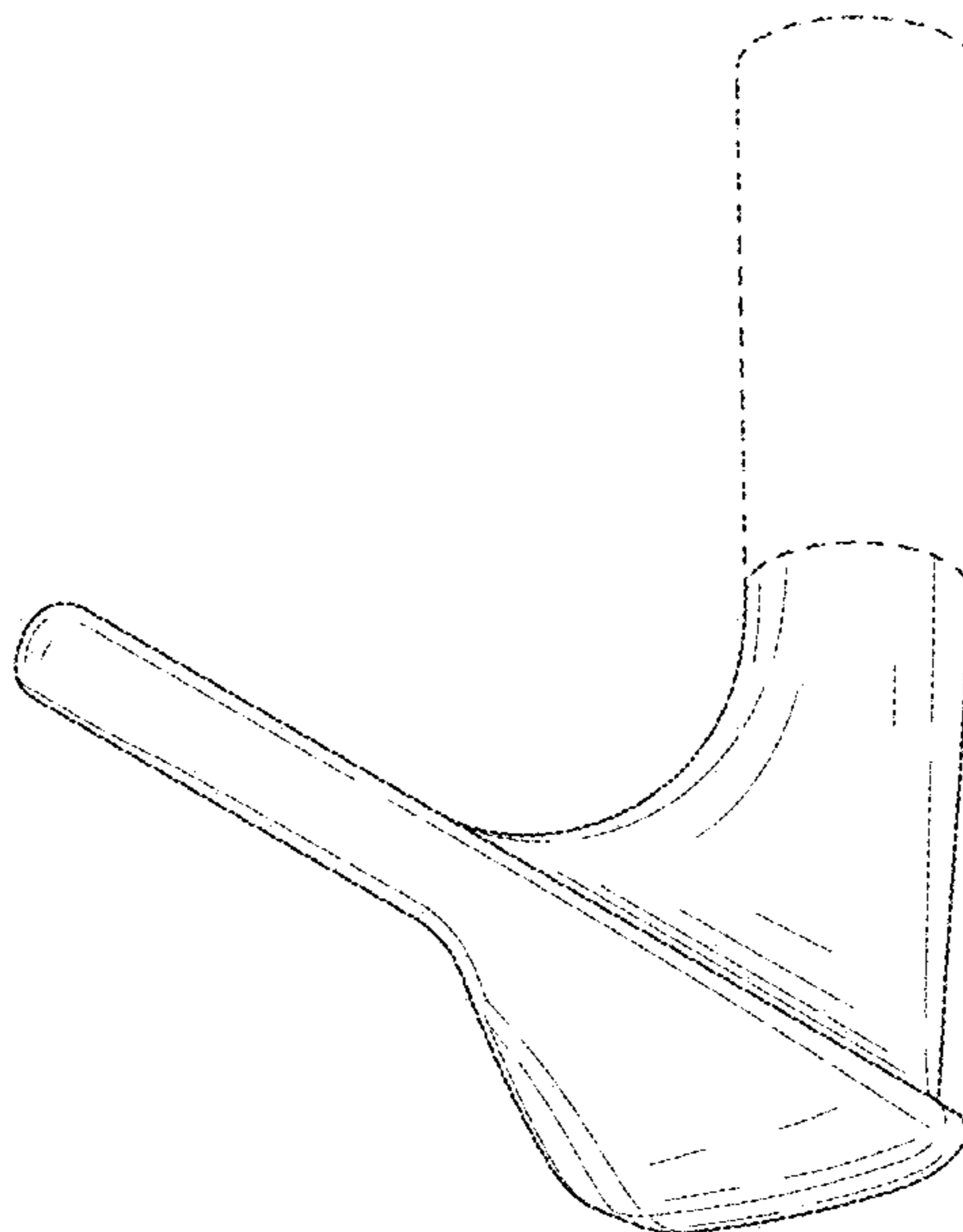

FIG. 8

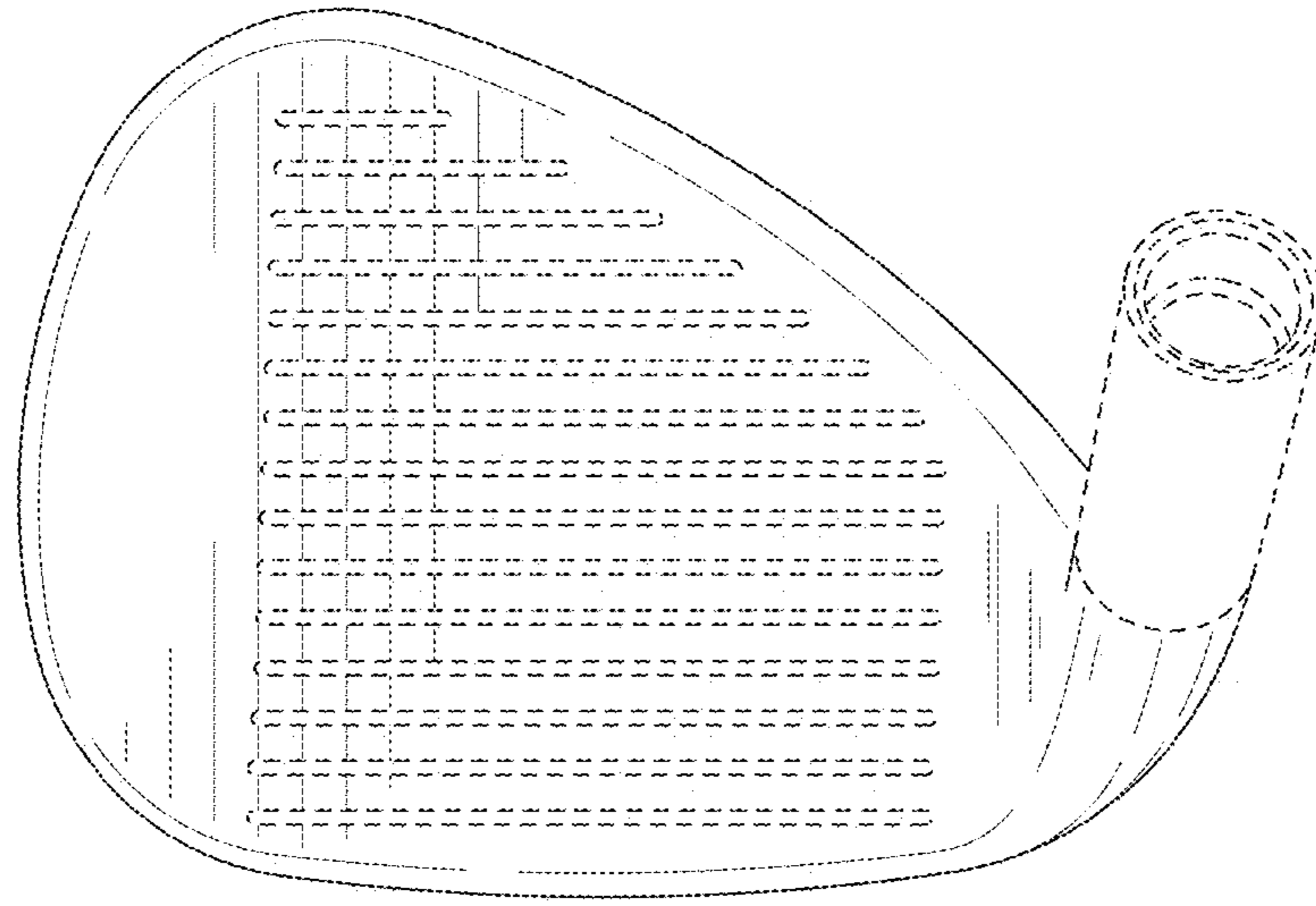

FIG. 9

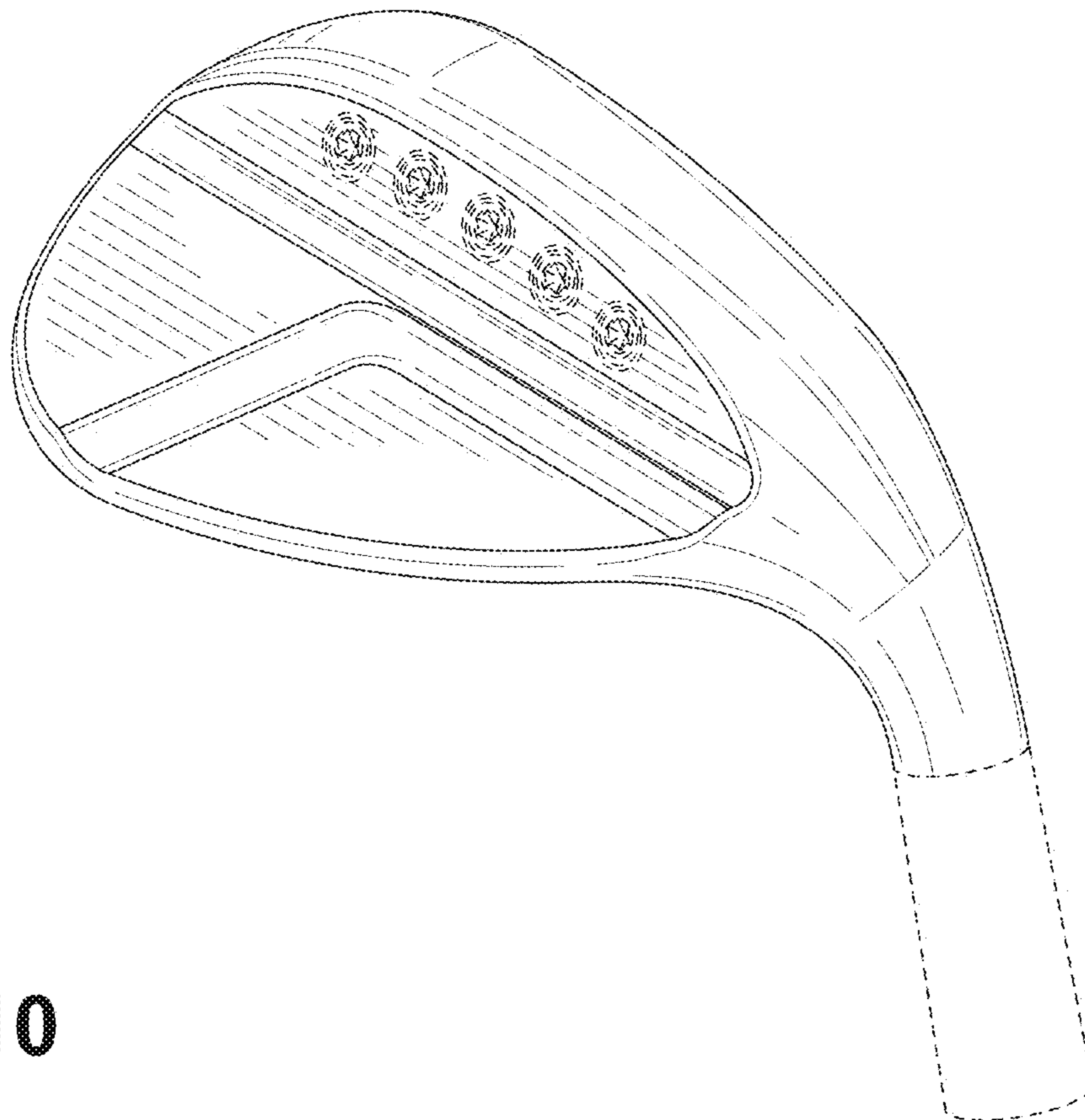

FIG. 10

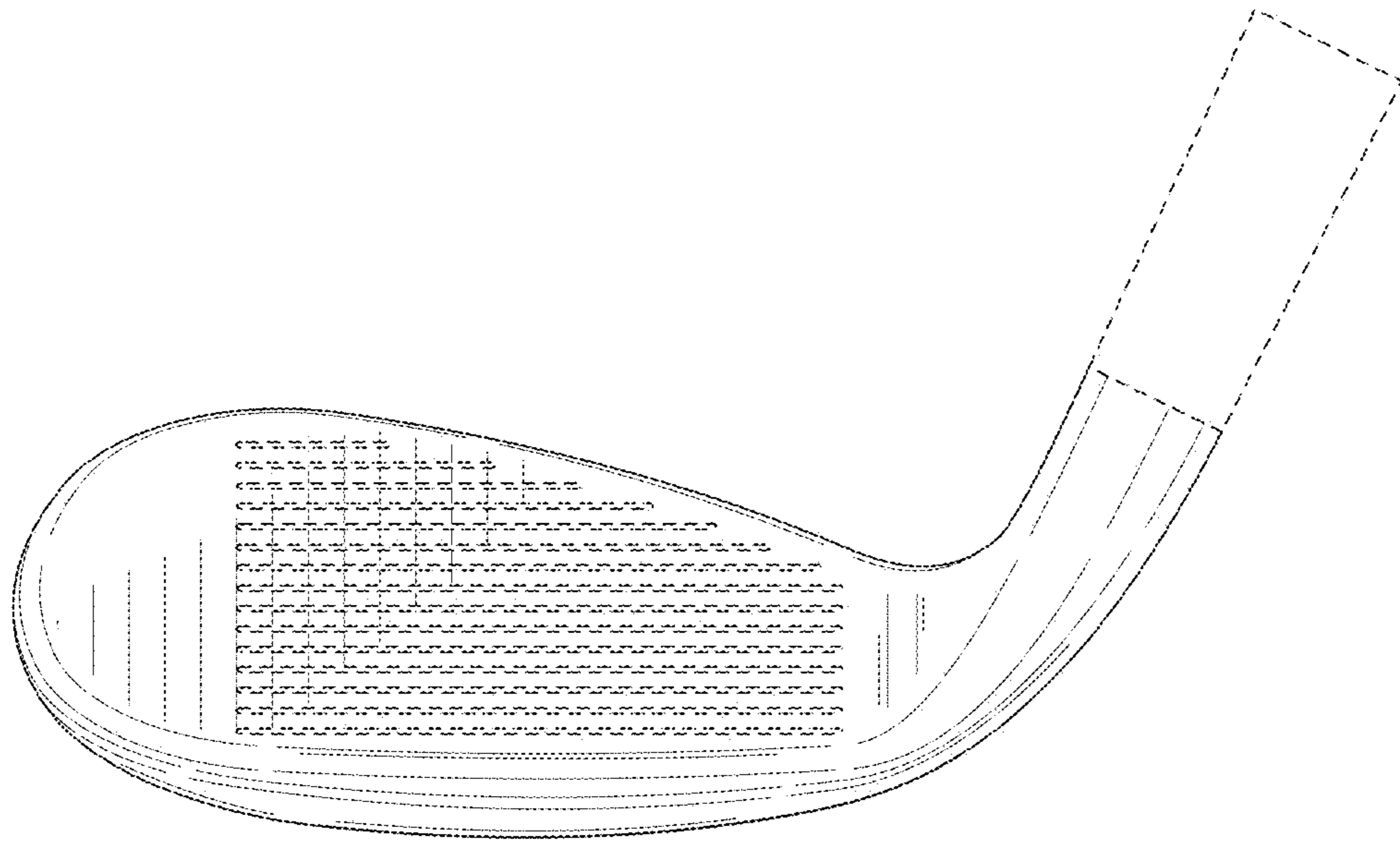

FIG. 11

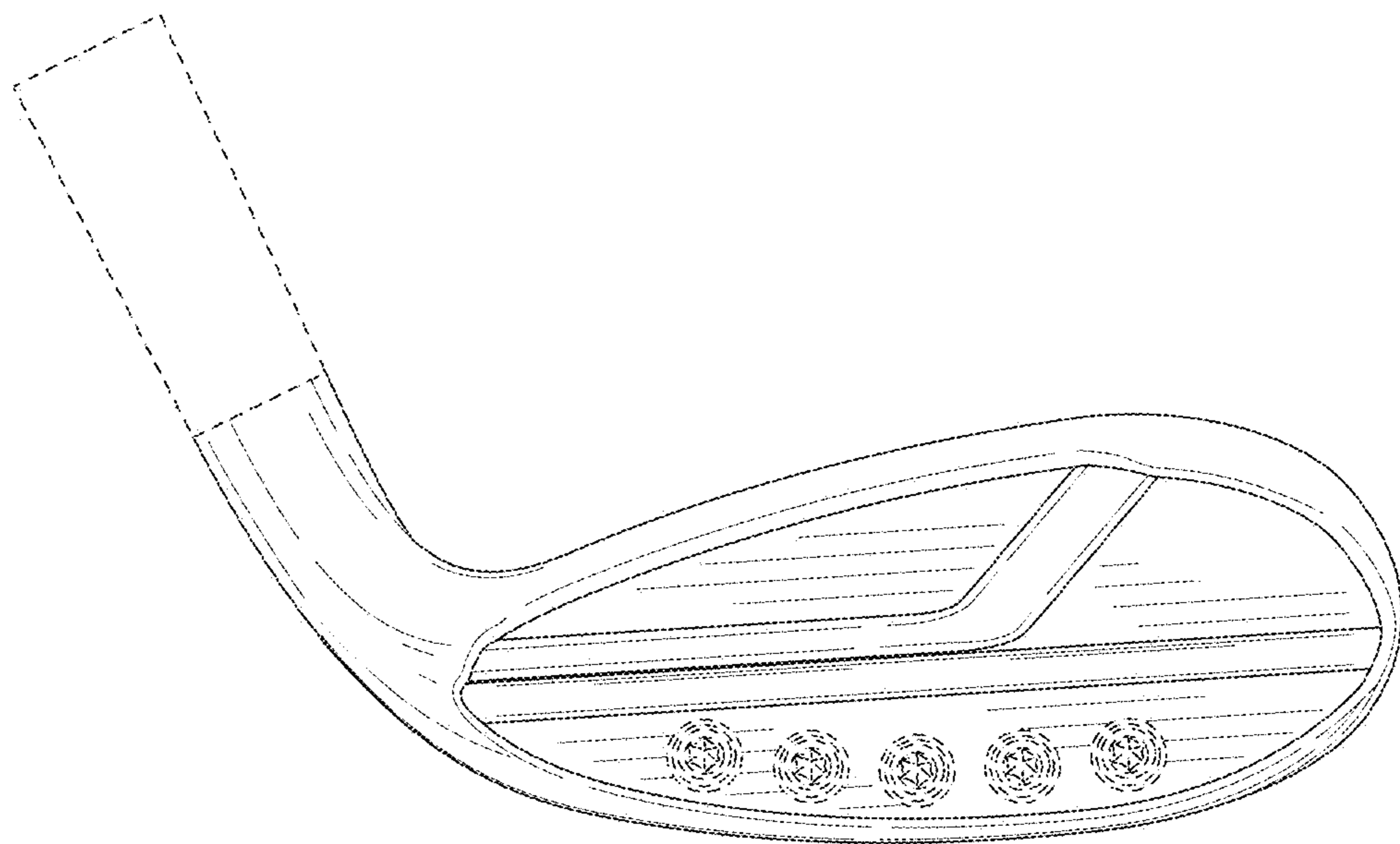

FIG. 12

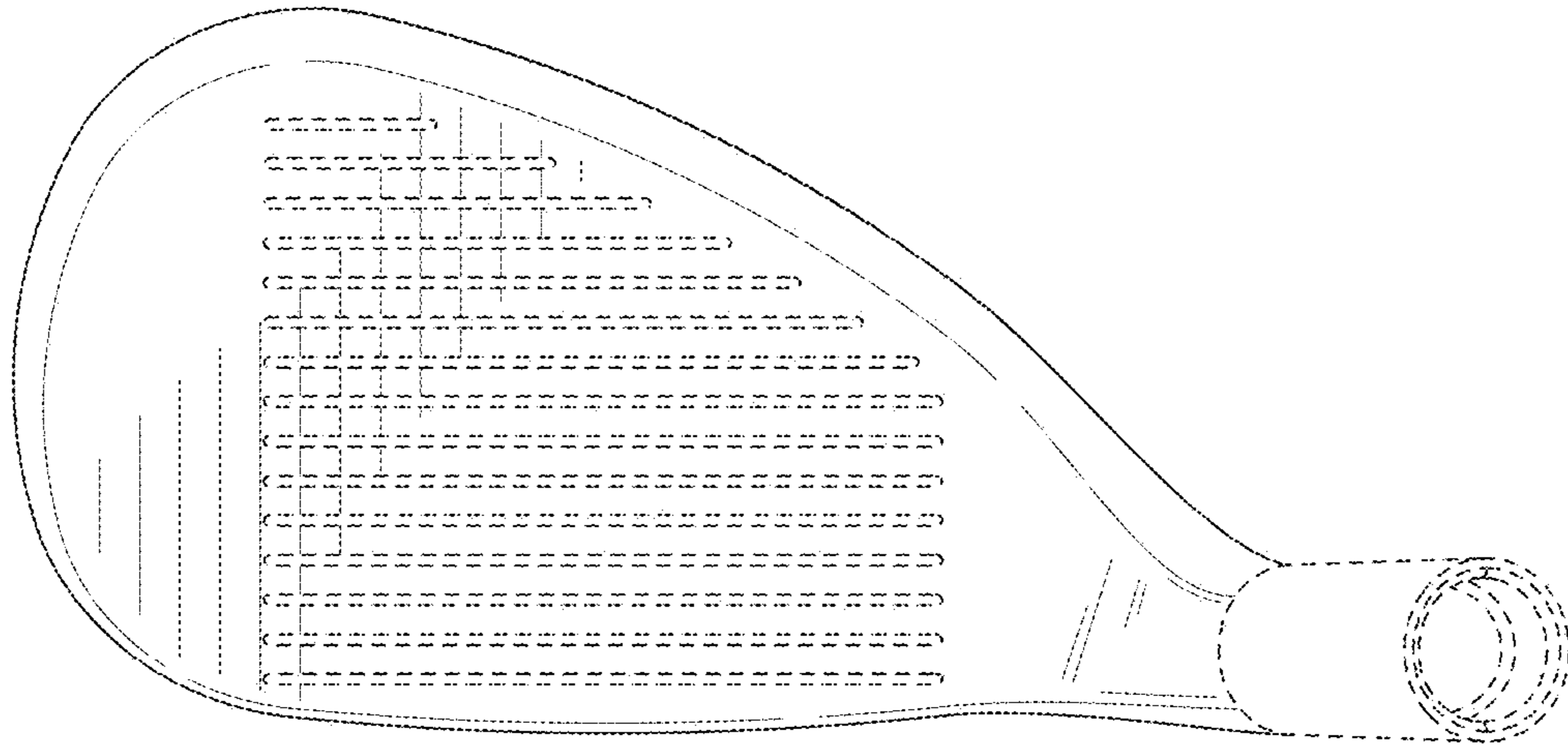

FIG. 13

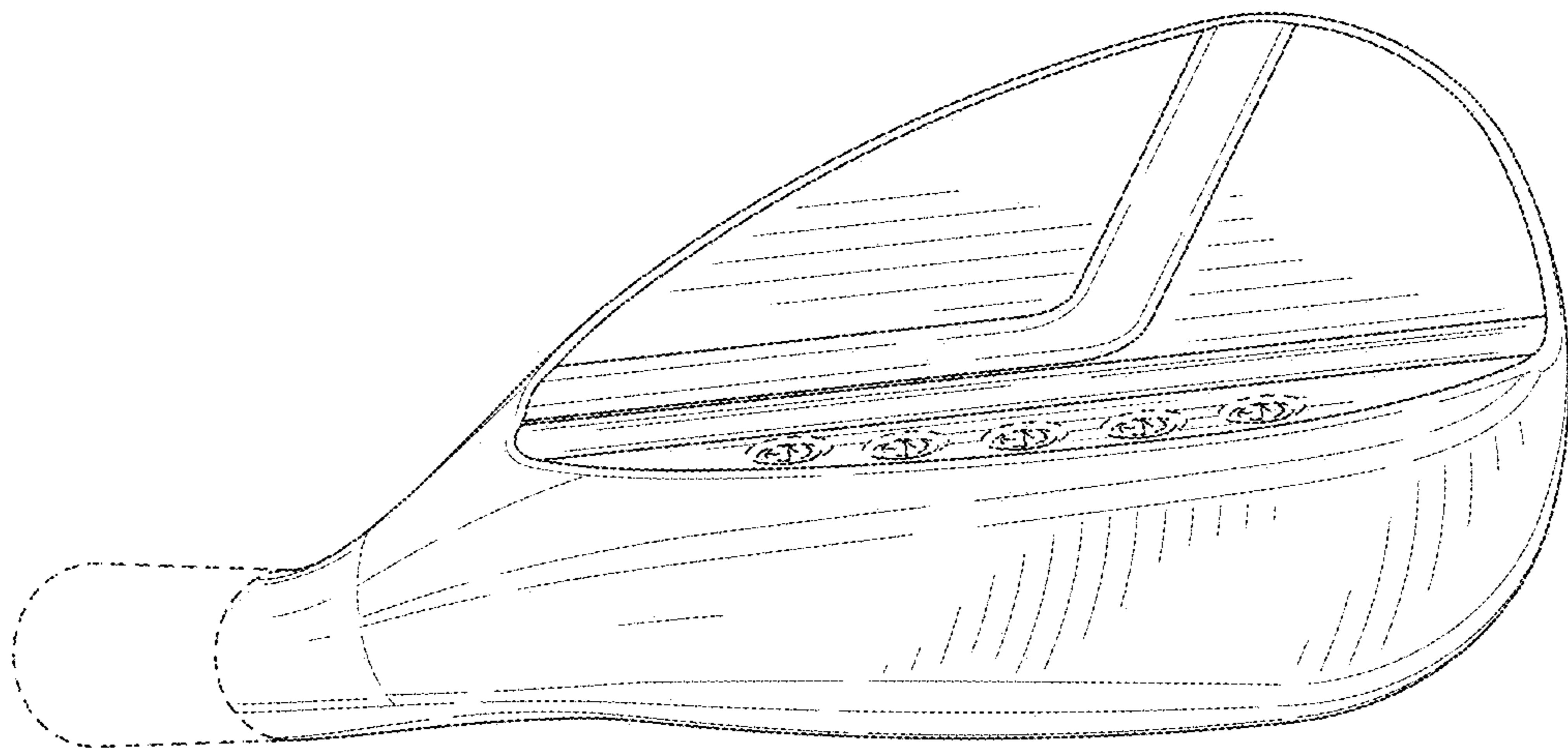

FIG. 14

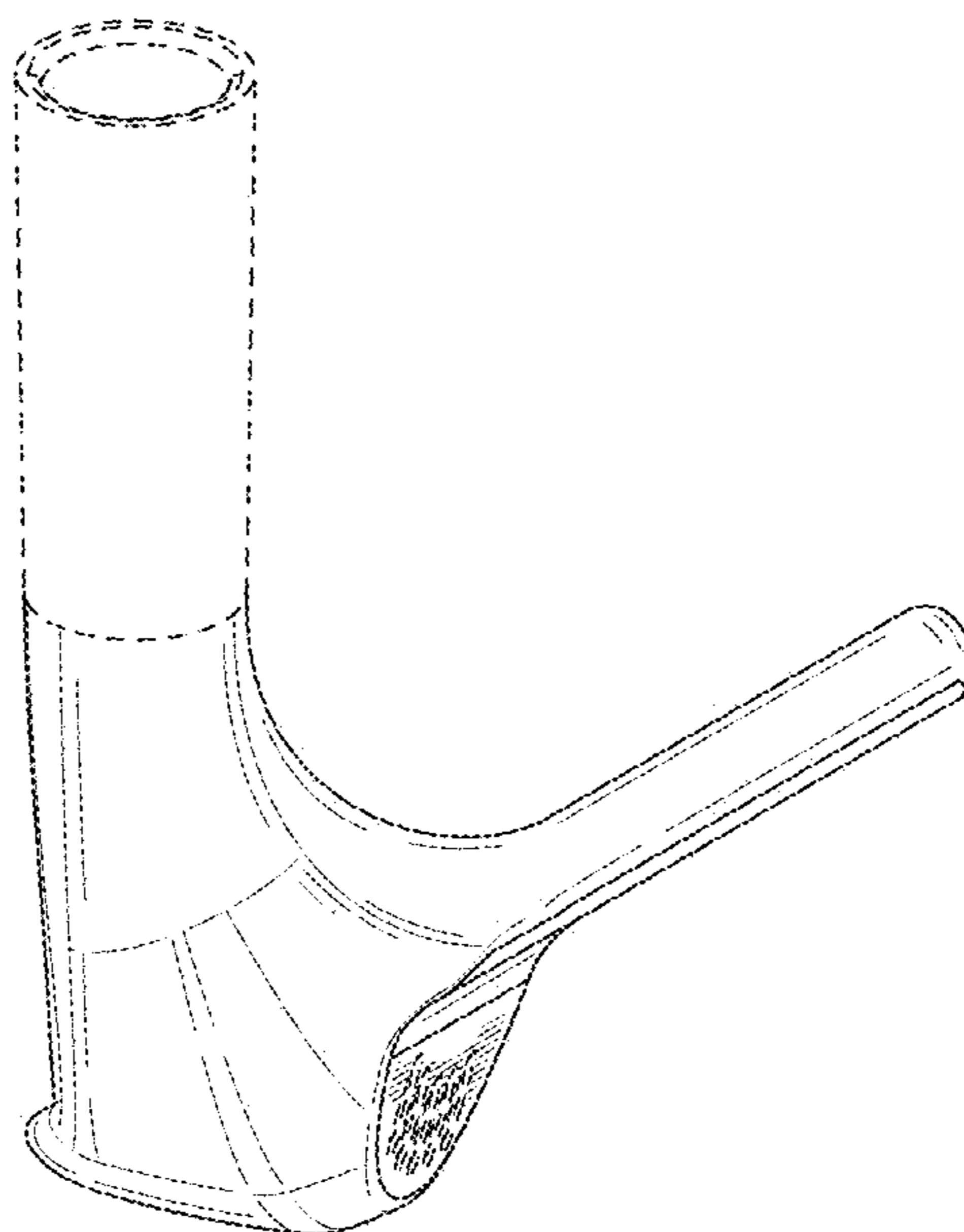

FIG. 15

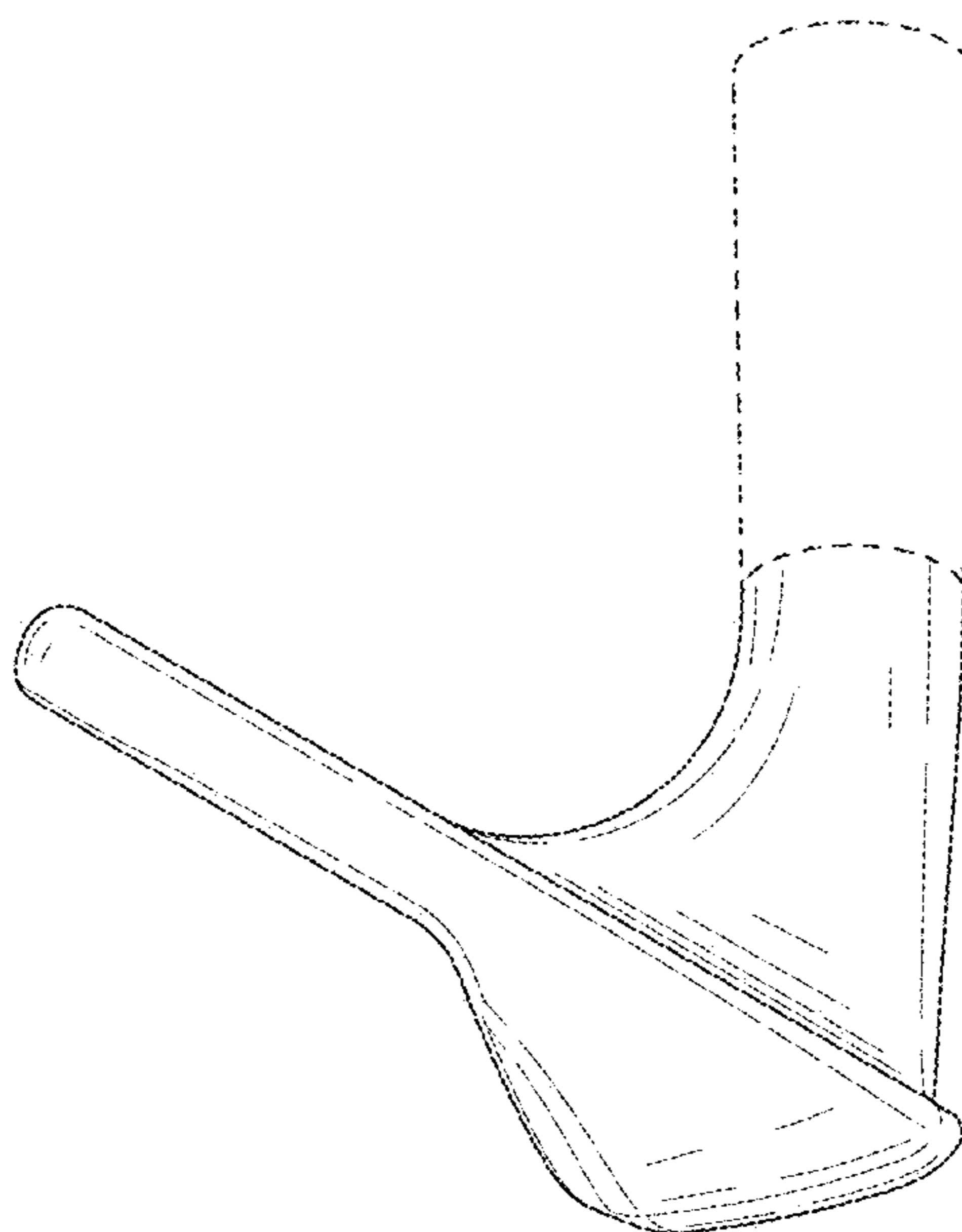

FIG. 16