



US00D927499S

(12) **United States Design Patent** (10) **Patent No.:** **US D927,499 S**  
**Wengreen et al.** (45) **Date of Patent:** **\*\* Aug. 10, 2021**

(54) **MOUNT FOR ELECTRONIC DEVICES**

(71) Applicant: **Innovelis, Inc.**, Sammamish, WA (US)

(72) Inventors: **Eric John Wengreen**, Sammamish, WA (US); **Ian Jacob van de Kamp**, Seattle, WA (US)

(73) Assignee: **Innovelis, Inc.**, Sammamish, WA (US)

(\*\*) Term: **15 Years**

(21) Appl. No.: **29/757,270**

(22) Filed: **Nov. 4, 2020**

(51) **LOC (13) Cl.** ..... **08-07**

(52) **U.S. Cl.**  
USPC ..... **D14/447**

(58) **Field of Classification Search**  
USPC ..... D14/447, 432, 434, 439, 440, 451, 452, D14/457, 239, 253; D8/363, 373, 380; D6/406.3, 406.4, 406.5, 406.6; D12/415  
CPC ..... A47B 21/04; A47B 2097/006; A47B 2097/005; A47B 2023/049; A45C 2011/002; A45C 2011/003; F16M 2200/00; F16M 13/00  
See application file for complete search history.

(56) **References Cited**

**U.S. PATENT DOCUMENTS**

D614,427 S	4/2010	Nejad	
D627,340 S *	11/2010	Lan	D14/253
D643,659 S	8/2011	Choi	
D662,502 S *	6/2012	Wesolek	D14/434
D716,580 S	11/2014	Wengreen	
D727,143 S	4/2015	Gomez	
D729,544 S	5/2015	Wengreen	
D749,597 S *	2/2016	Wengreen	D14/447
D751,563 S *	3/2016	Wengreen	D14/447

D804,845 S	12/2017	Cockburn	
D808,188 S	1/2018	Cockburn	
D824,399 S *	7/2018	Wengreen	D14/447
D832,858 S	11/2018	Wengreen	
D845,027 S *	4/2019	Corona	D6/553
D845,028 S	4/2019	Corona	
D845,310 S *	4/2019	Wengreen	D14/447
D845,959 S *	4/2019	Wengreen	D14/447
D877,137 S	3/2020	Engerman	
D883,755 S	5/2020	Nicholson	
D903,429 S	12/2020	Joseph	
D905,067 S *	12/2020	Wengreen	D14/447
D905,068 S *	12/2020	Wengreen	D14/447
D905,069 S *	12/2020	Wengreen	D14/447
D914,690 S *	3/2021	Wengreen	D14/447
D914,691 S *	3/2021	Wengreen	D14/447

\* cited by examiner

*Primary Examiner* — Angela J Lee

(57) **CLAIM**

The ornamental design for a mount for electronic devices, as shown and described.

**DESCRIPTION**

FIG. 1 is a front, first side, and top perspective view of a mount for electronic devices embodying the new design; FIG. 2 is a back, second side, and bottom perspective view thereof; FIG. 3 is a top, back, and first side perspective view thereof; FIG. 4 is a front view thereof; FIG. 5 is a back view thereof; FIG. 6 is a second side view thereof; FIG. 7 is a first side view thereof; FIG. 8 is a bottom view thereof; and, FIG. 9 is a top view thereof.

The uniform repeating broken lines depict portions of a mount for electronic devices in which the claimed design is embodied and form no part of the claimed design.

**1 Claim, 9 Drawing Sheets**

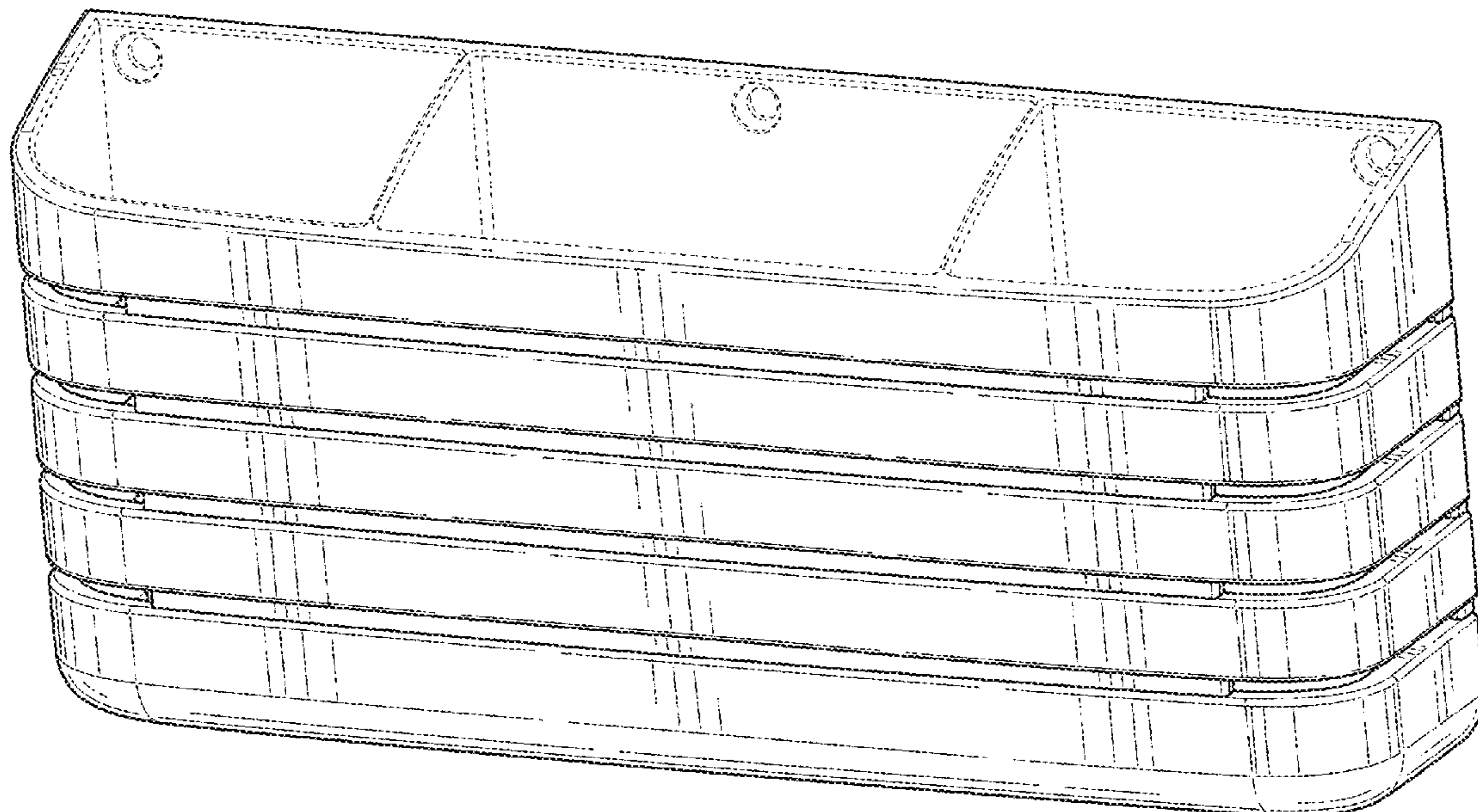

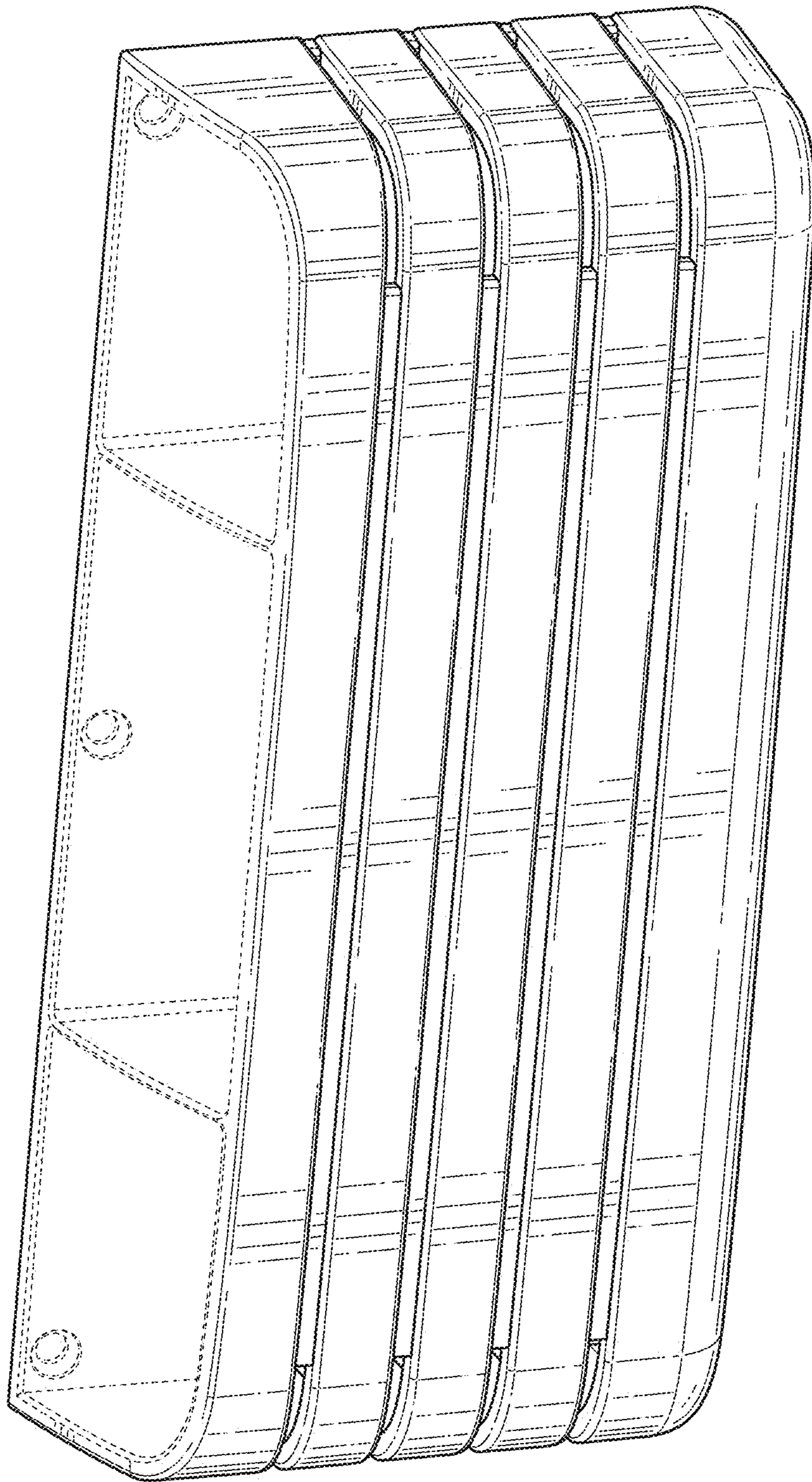

FIG. 1

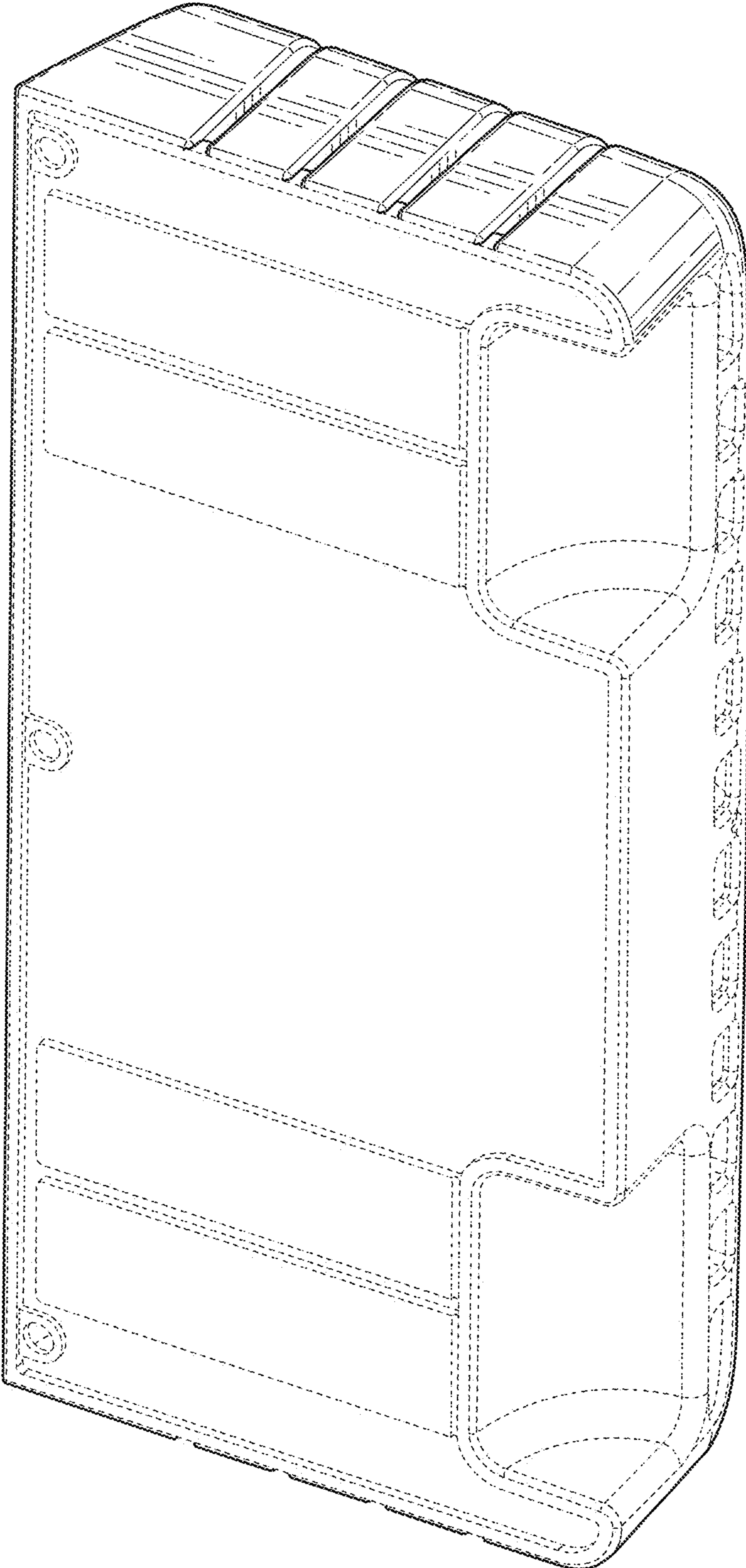

FIG. 2

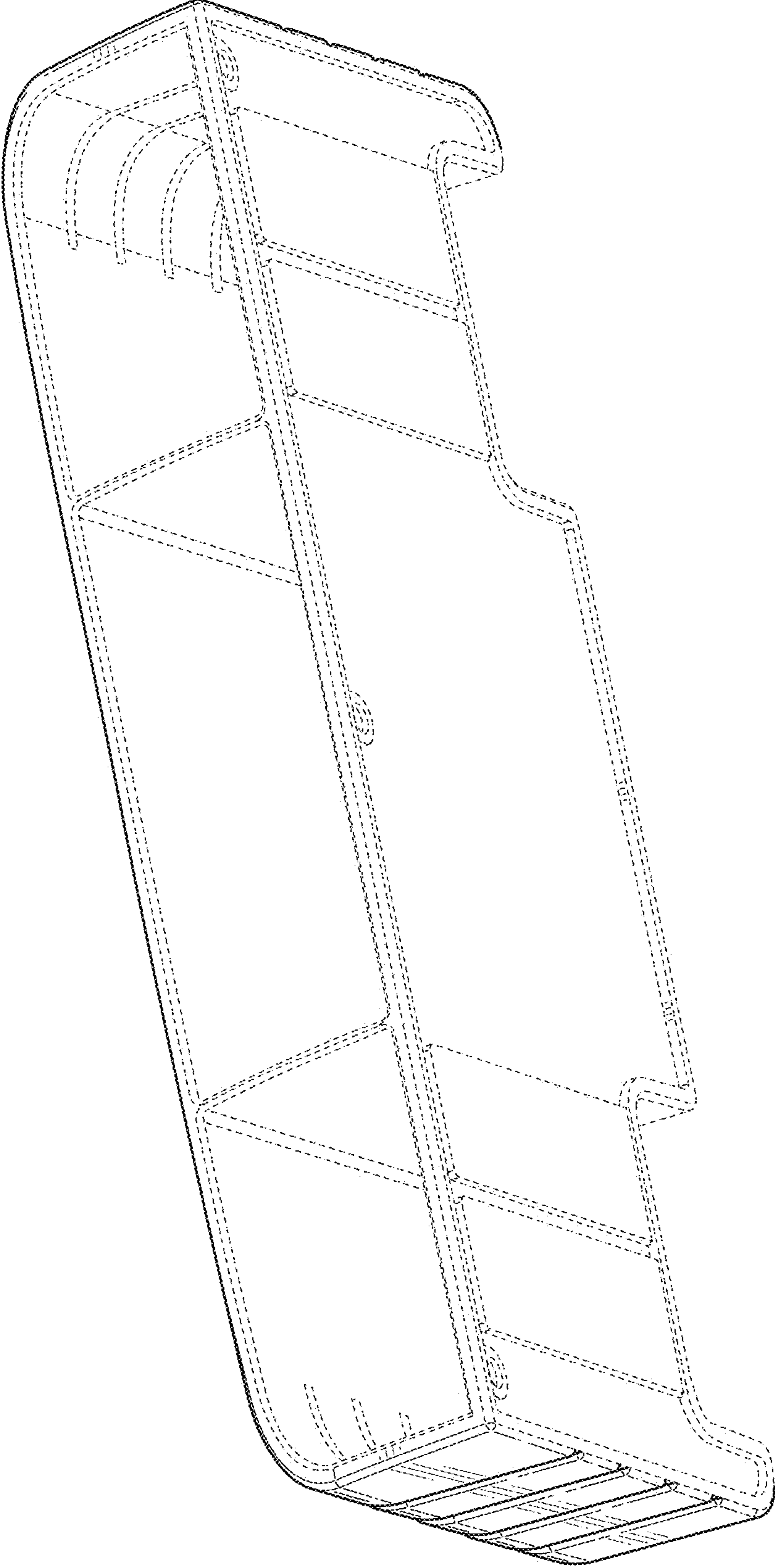

FIG. 3

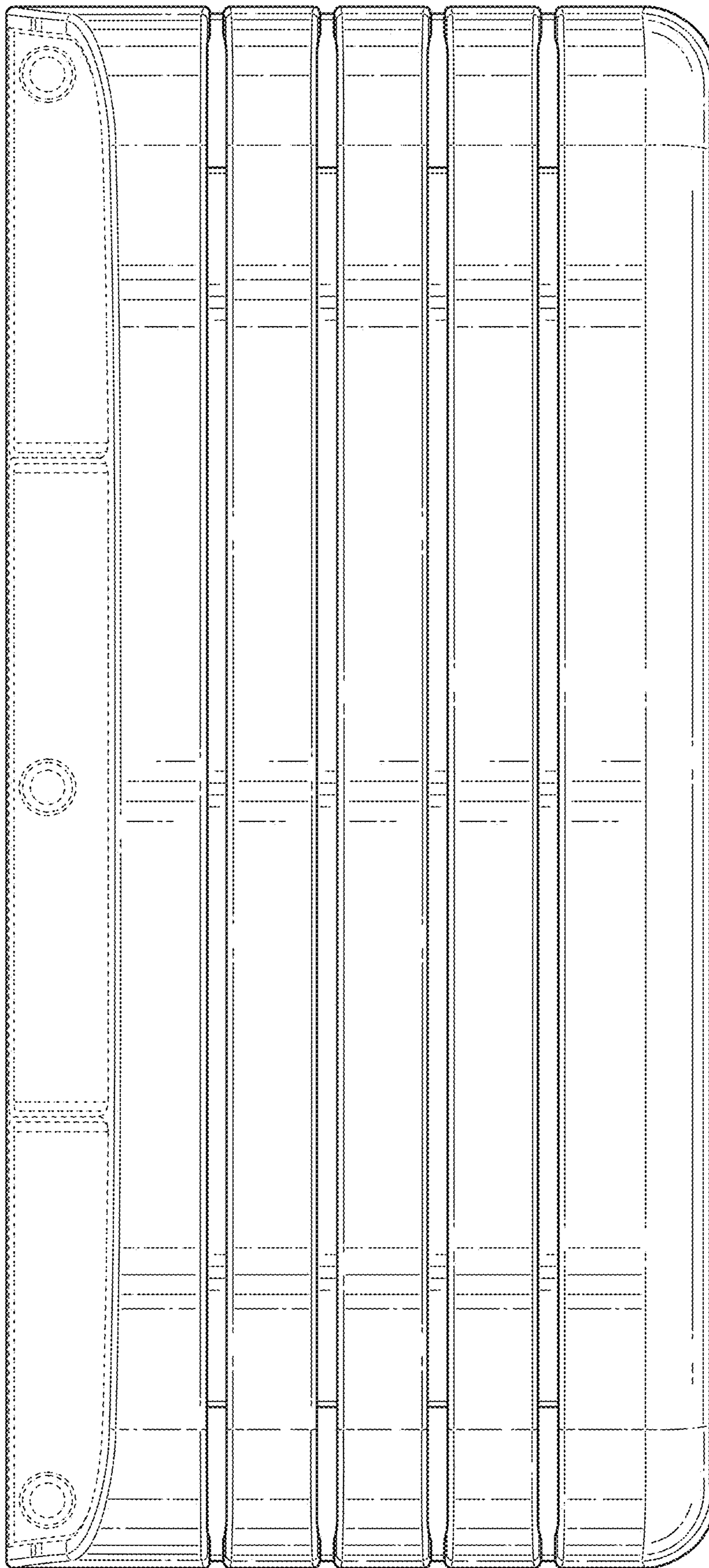

FIG. 4

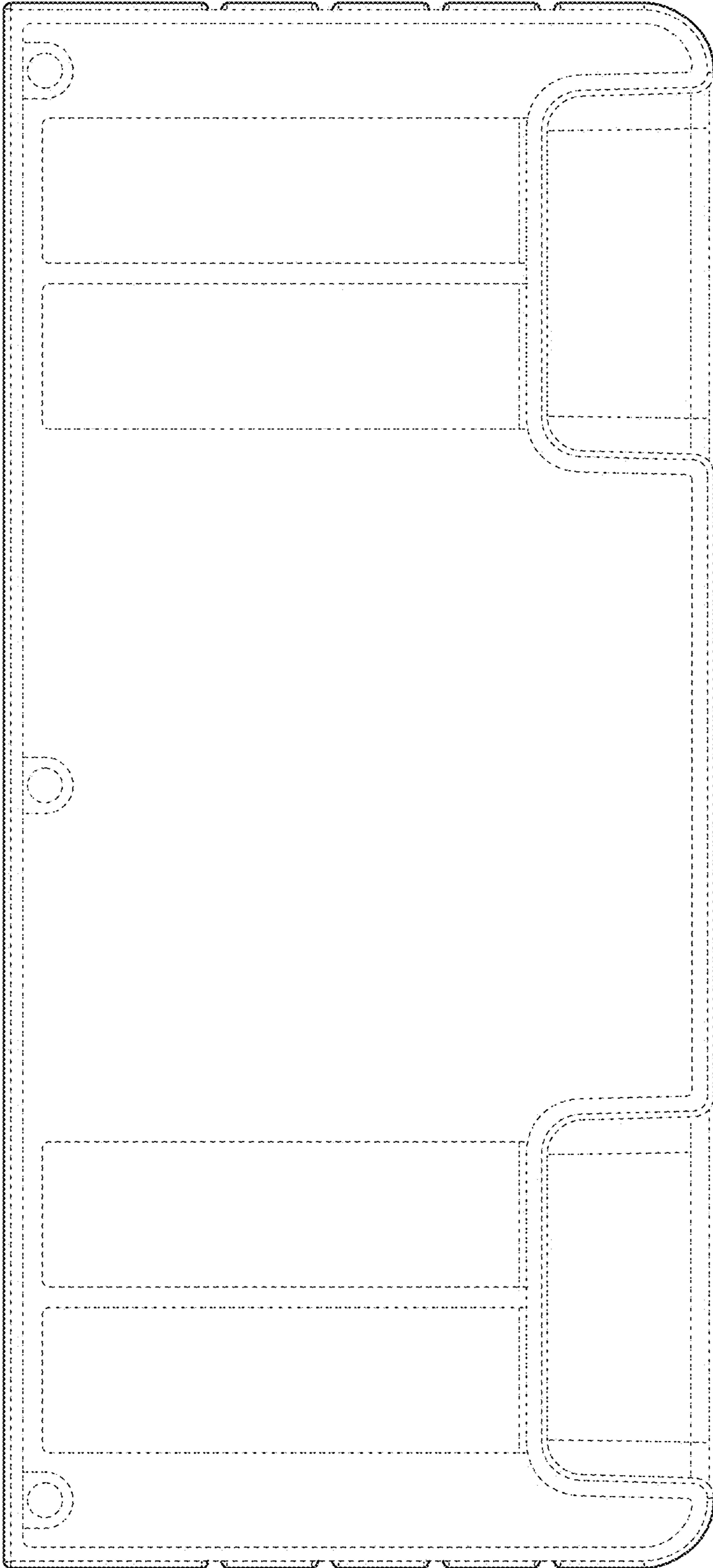

FIG. 5

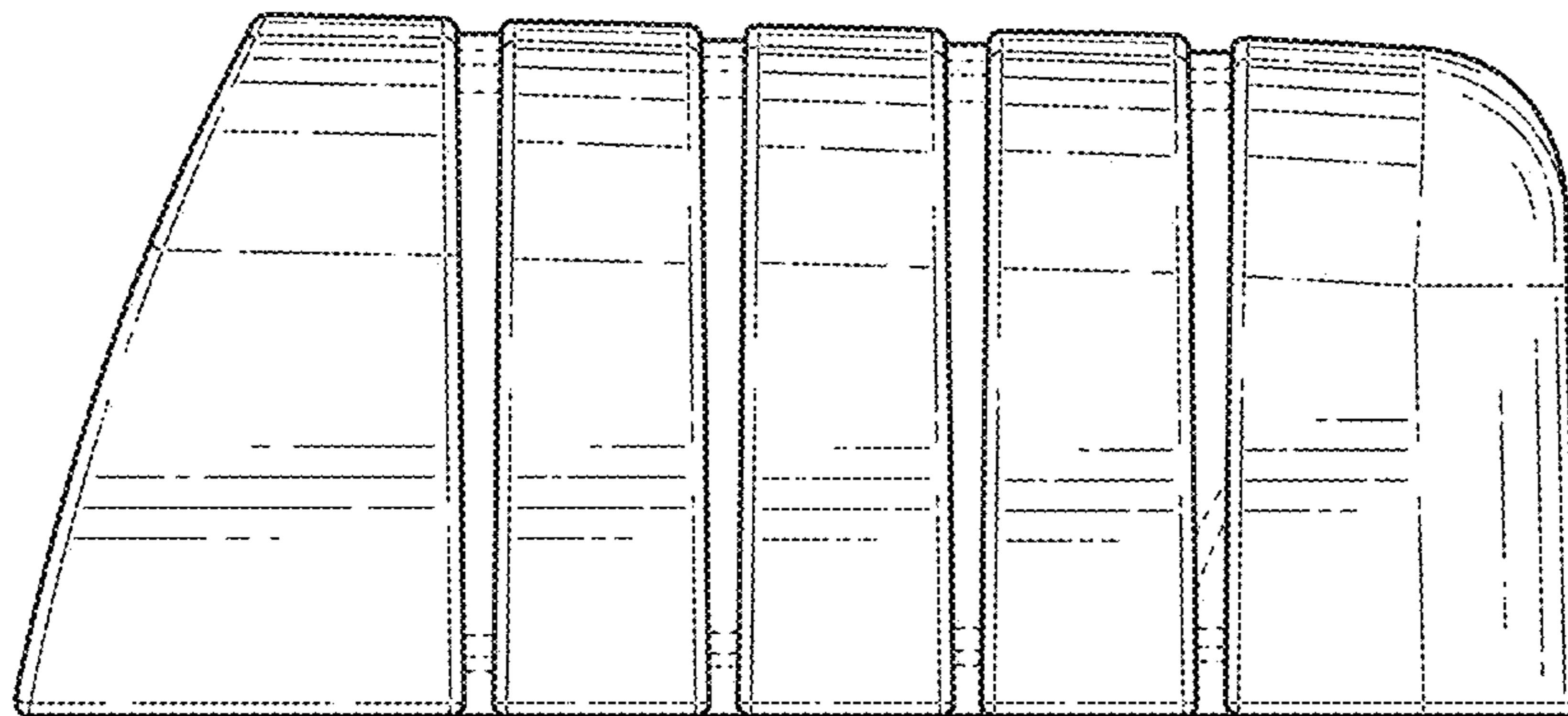

FIG. 6

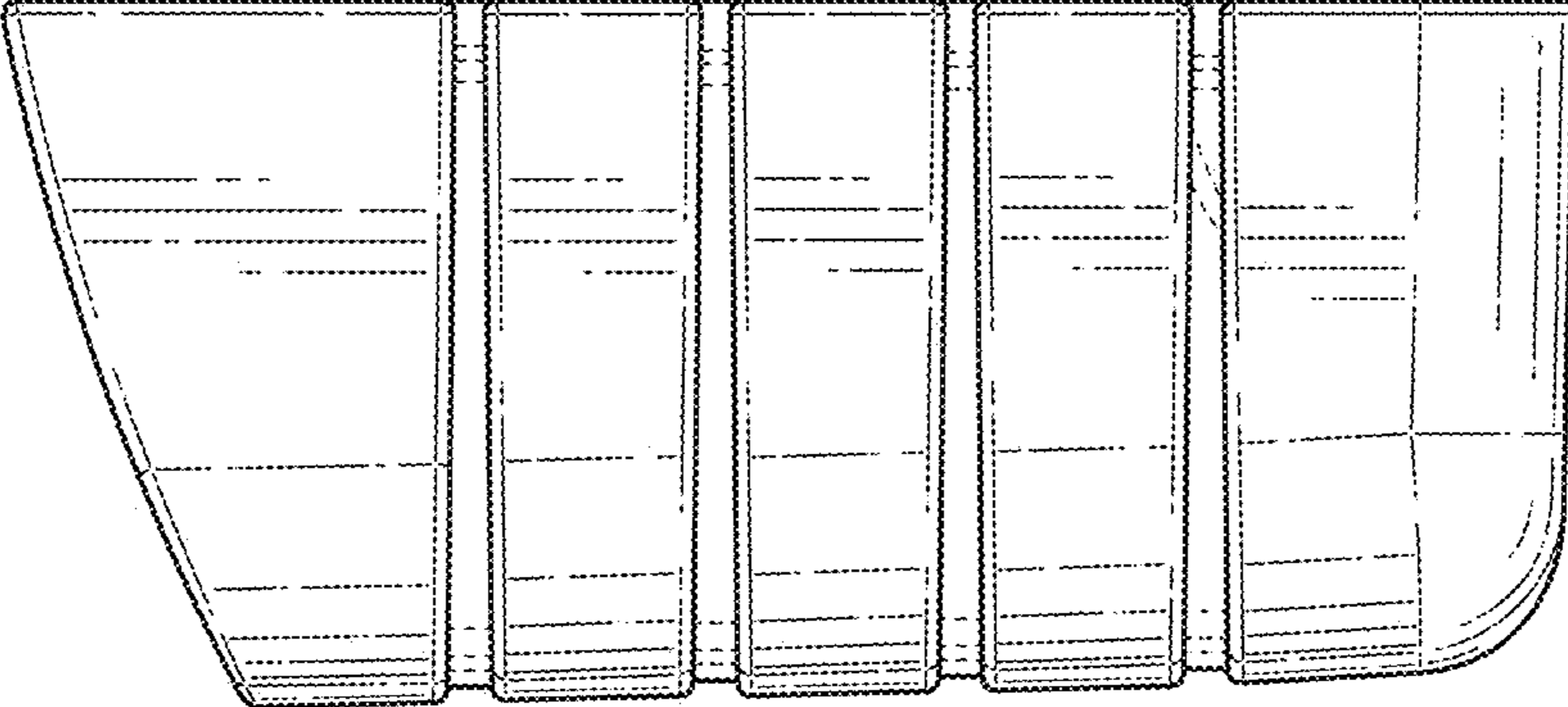

FIG. 7



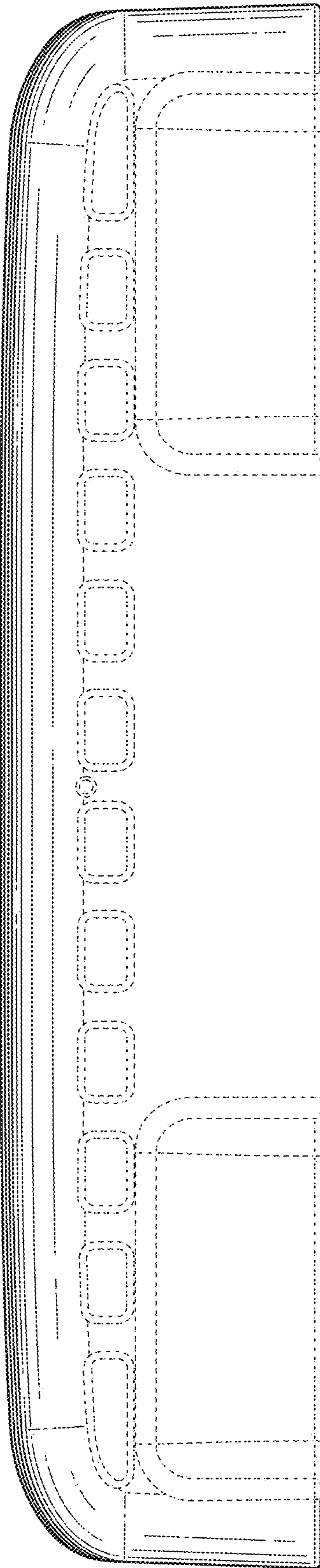

FIG. 8

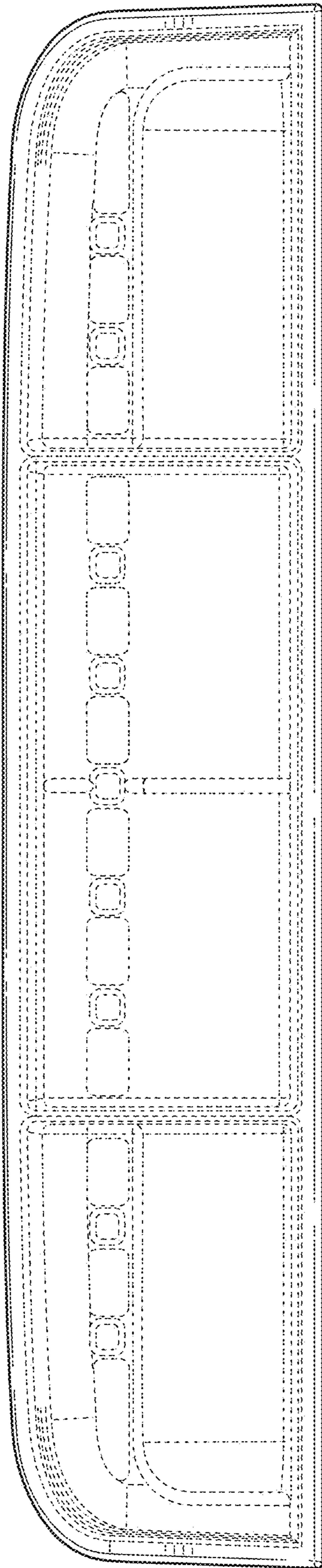

FIG. 9