



US00D927472S

(12) **United States Design Patent** (10) **Patent No.:** **US D927,472 S**
Ahn (45) **Date of Patent:** **** Aug. 10, 2021**

(54) **CASE FOR ELECTRONIC COMMUNICATIONS DEVICE**
(71) Applicant: **SPIGEN KOREA CO., LTD.**, Seoul (KR)
(72) Inventor: **Deok Hyun Ahn**, Seoul (KR)
(73) Assignee: **SPIGEN KOREA CO., LTD.**, Seoul (KR)
(*) Notice: Patent file contains an affidavit/declaration under 37 CFR 1.130(b).
(**) Term: **15 Years**
(21) Appl. No.: **29/704,719**
(22) Filed: **Sep. 6, 2019**
(51) **LOC (13) Cl.** **14-03**
(52) **U.S. Cl.**
USPC **D14/250**
(58) **Field of Classification Search**
USPC D3/201, 218, 226, 227, 247, 249, 250, D3/269, 303; D13/103, 107, 108, 119; D14/137, 138 R, 138 AA, 138 C, 138 G, D14/172, 192, 203.3–203.7, 217, 238.1, D14/247, 248, 250–253, 434, 440, 447, D14/496
CPC H04B 1/3888; H04M 1/0283; H04M 1/0202; A45C 1/06; A45C 2011/002; A45C 11/00; A45F 2005/028; A45F 2200/0525
See application file for complete search history.

D668,646 S 10/2012 Li
D677,249 S 3/2013 Li
D679,271 S 4/2013 Liu
D679,692 S 4/2013 Fahrendorff et al.
(Continued)

OTHER PUBLICATIONS

Spigen Rugged Armor for Apple iPhone X, earliest photo review date Dec. 17, 2017, [online][site visited Mar. 16, 2020] URL: <https://www.amazon.com/Spigen-Rugged-Armor-Designed-iPhone/dp/B074CNF6YW> (Year: 2017).*
(Continued)

Primary Examiner — Susan E Krakower
Assistant Examiner — L. A. Grabenstetter
(74) *Attorney, Agent, or Firm* — Heedong Chae; Lucem, PC

(57) **CLAIM**

The ornamental design for a case for electronic communications device, as shown and described.

DESCRIPTION

FIG. 1 is a front perspective view of a case for electronic communications device showing my new design; FIG. 2 is a rear perspective view thereof; FIG. 3 is a front elevational view thereof; FIG. 4 is a rear elevational view thereof; FIG. 5 is a left side elevational view thereof; FIG. 6 is a right side elevational view thereof; FIG. 7 is a top plan view thereof; FIG. 8 is a bottom plan view thereof; and, FIG. 9 is an enlarged view of the encircled region in FIG. 2. The dot-dash broken line circles in FIGS. 2 and 9 are included for the purpose of illustrating the portion of the case for electronic communications device shown in an enlarged scale in FIG. 9. The dot-dash broken line forms no part of the claimed design.

1 Claim, 9 Drawing Sheets

(56) **References Cited**
U.S. PATENT DOCUMENTS
D619,361 S 7/2010 Andre et al.
D646,265 S 10/2011 Fathollahi
D650,371 S 12/2011 Wibby
D654,491 S 2/2012 Melanson et al.
D655,281 S 3/2012 Turocy

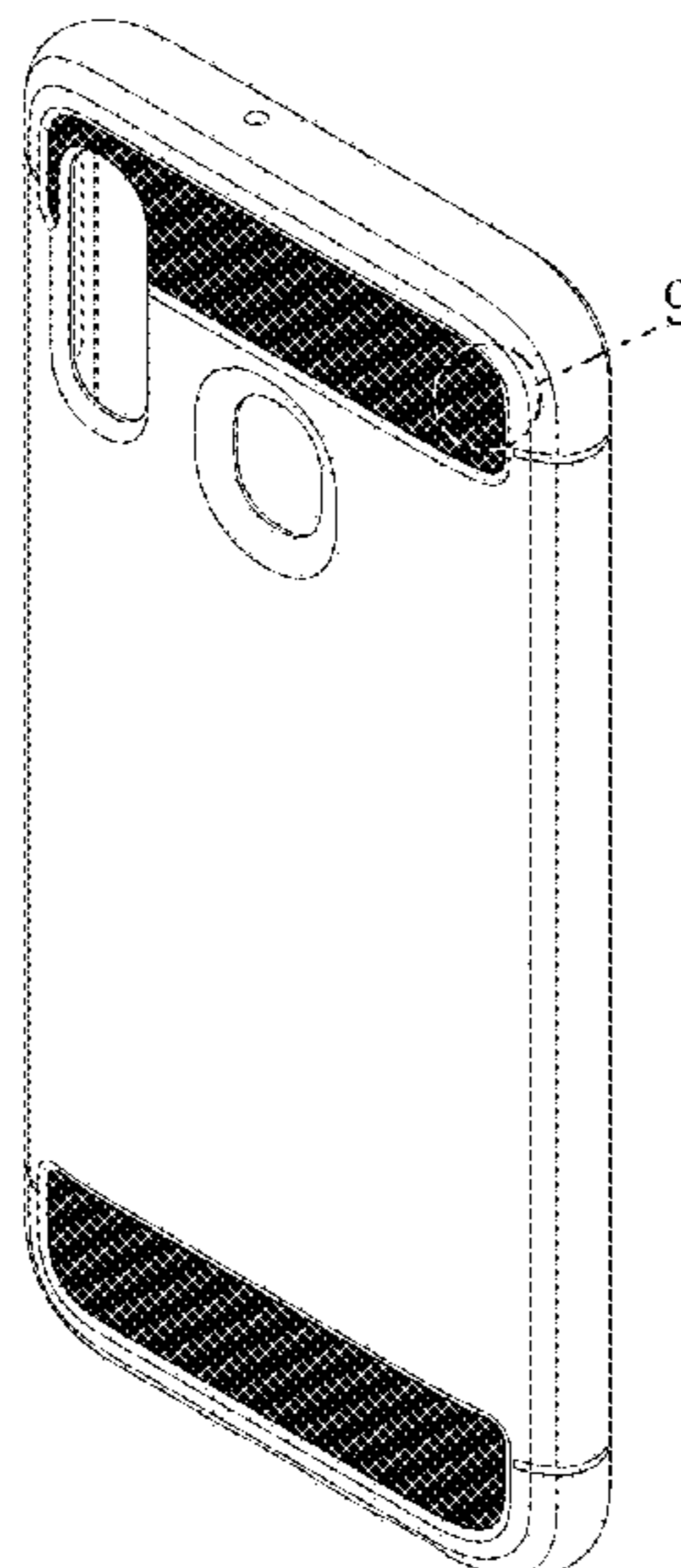

(56)

References Cited

U.S. PATENT DOCUMENTS

D681,615 S 5/2013 Fathollahi
 D681,617 S 5/2013 Weller et al.
 D683,340 S 5/2013 Chang et al.
 D684,568 S 6/2013 Fitzgerald
 D697,905 S 1/2014 Chang
 D698,767 S 2/2014 Son
 D700,172 S 2/2014 Li
 D700,174 S * 2/2014 Li D14/248
 D706,254 S 6/2014 Chang
 D714,273 S 9/2014 Kim et al.
 D716,281 S 10/2014 Melanson et al.
 D716,282 S 10/2014 Melanson et al.
 D717,774 S 11/2014 Fathollahi
 D720,759 S 1/2015 Deng et al.
 D721,070 S 1/2015 Pickett
 D727,883 S 4/2015 Brand
 D731,481 S 6/2015 Akana et al.
 D732,012 S 6/2015 Tsai
 D733,693 S 7/2015 Wang et al.
 D739,391 S 9/2015 Chen et al.
 D741,845 S 10/2015 Kim
 D743,387 S 11/2015 Choi
 D746,273 S 12/2015 Herbst
 D746,274 S 12/2015 Herbst
 D748,614 S 2/2016 Ju
 D749,068 S 2/2016 Zaborski et al.
 D749,535 S 2/2016 Joung et al.
 D749,555 S 2/2016 Poon et al.
 D749,557 S 2/2016 Feng
 D756,343 S 5/2016 Wall
 D756,909 S 5/2016 Gupta
 D756,910 S 5/2016 Gupta
 D756,911 S 5/2016 Gupta
 D757,699 S * 5/2016 Lee D14/248
 D761,239 S 7/2016 Kim
 D763,241 S 8/2016 Kim
 D763,242 S 8/2016 Kim
 D763,837 S 8/2016 Choe et al.
 D763,842 S 8/2016 Chang et al.
 D765,627 S 9/2016 Watt
 D765,635 S 9/2016 Chang et al.
 D765,638 S 9/2016 Gaylord et al.
 D765,640 S 9/2016 Bulkley et al.
 D765,641 S 9/2016 Bulkley et al.
 D765,642 S 9/2016 Bulkley
 D765,645 S 9/2016 Kim
 D767,485 S 9/2016 To et al.
 D767,554 S 9/2016 Bertrand et al.
 D770,188 S * 11/2016 Fang D5/53
 D771,611 S 11/2016 Chang et al.
 D772,854 S 11/2016 Igarashi
 9,480,319 B2 11/2016 Dining et al.
 D775,614 S 1/2017 Kim
 D776,647 S 1/2017 Kim
 D777,157 S 1/2017 Kim
 D777,160 S 1/2017 Kim
 D781,835 S 3/2017 Kim et al.
 D781,840 S 3/2017 Kim et al.
 D782,460 S 3/2017 Bertrand et al.
 D783,602 S 4/2017 Akana et al.
 D784,309 S 4/2017 Lee et al.
 D785,615 S 5/2017 Kim et al.
 D786,849 S 5/2017 Park et al.
 D786,853 S 5/2017 Friedland et al.
 D788,090 S * 5/2017 Kim D14/250
 D788,093 S 5/2017 Lee et al.
 D792,394 S 7/2017 Lee et al.
 D795,237 S 8/2017 Jung et al.
 D797,715 S 9/2017 Kim
 D798,286 S 9/2017 Roberts et al.
 D801,323 S 10/2017 Kim
 D801,324 S 10/2017 Kim
 D801,325 S 10/2017 Kim
 D801,959 S 11/2017 Kuo et al.
 D806,082 S * 12/2017 Armstrong D14/440

D807,336 S 1/2018 Kim
 D813,219 S 3/2018 Hyun
 D815,627 S 4/2018 Cho et al.
 D819,006 S 5/2018 Kim
 D824,377 S 7/2018 Kim et al.
 D826,929 S 8/2018 Andre et al.
 D831,017 S 10/2018 Choe et al.
 D832,833 S * 11/2018 Kim D14/250
 D837,779 S 1/2019 Kim
 D838,264 S 1/2019 Wright et al.
 D838,706 S 1/2019 Li et al.
 D838,710 S 1/2019 Wang
 D840,992 S 2/2019 Kim
 D841,637 S * 2/2019 Kim D14/250
 D843,360 S 3/2019 Han et al.
 D843,993 S 3/2019 Jeong et al.
 D843,994 S 3/2019 Jeong et al.
 D845,943 S 4/2019 Skovsted et al.
 D845,944 S 4/2019 Gronewoller et al.
 D845,945 S 4/2019 Bohman et al.
 D847,129 S 4/2019 To et al.
 D847,807 S 5/2019 Wright et al.
 D849,737 S * 5/2019 Kim D14/250
 D850,431 S 6/2019 Igarashi
 2011/0050606 A1 3/2011 Zhang
 2015/0189963 A1 7/2015 Lai

OTHER PUBLICATIONS

Huawei Hono 8X case from Sucnkp, publication date Sep. 17, 2018, [online][site visited Mar. 16, 2020] URL: <https://www.amazon.com/Sucnkp-Huawei-Absorption-Technology-Protective/dp/B07FVRTHTK> (Year: 2018).*

Meet Spigen Huawei P20 Pro Rugged Armor Case, publication date Apr. 25, 2018, [online][site visited Mar. 16, 2020] URL: <https://www.gizguide.com/2018/04/spigen-p20-pro-rugged-case.html> (Year: 2018).*

Huawei P20 Pro Spigen Rugged armor case Unboxing!, publication date May 23, 2018, [online][site visited Mar. 16, 2020] URL: <https://www.youtube.com/watch?v=ChyMYk8kHug> (Year: 2018).*

Samsung Galaxy A40 Case by Maikezi, publication date Mar. 13, 2019, [online][site visited Mar. 16, 2020] URL: <https://www.amazon.com/Samsung-MAIKEZI-Anti-Fingerprint-Full-Body-Protective/dp/B07NY155L7> (Year: 2019).*

Maikezi Case for Samsung A20 Phone, earliest photo verified review date Jun. 29, 2019, [online][site visited Sep. 23, 2020] URL: <https://www.amazon.com/Samsung-MAIKEZI-Anti-Fingerprint-Full-Body-Protective/dp/B07NYYWGM5> (Year: 2019).*

“Caseology Vault for Apple iPhone 8 Case (2017) / for iPhone 7 Case (2016)—Rugged & Flexible—Matte Black”, <https://www.amazon.com/dp/B01JSZOJ7M>, Earliest review date of Sep. 10, 2016, Downloaded on Jan. 16, 2020.

“The best iPhone 7 & 7 Plus cases available now”, <https://9to5mac.com/2016/09/07/best-iphone-7-7-plus-cases-accessories-available-now/>, Earliest review date of Sep. 17, 2016, Downloaded on Mar. 18, 2020.

“Caseology Vault for Google Pixel Case (2016)—Rugged & Flexible—Black”, <https://www.amazon.com/dp/B01MEDIMGS>, Earliest review date of Nov. 10, 2016, Downloaded on Jan. 16, 2020.

“Caseology Vault for Apple iPhone 7 Plus Case (2016)—Rugged Matte Finish—Black”, <https://www.amazon.com/dp/B01N2OCQV4>, Earliest review date of Dec. 16, 2016, Downloaded on Jan. 16, 2020.

“Caseology Vault for LG G6 Case (2017)—Rugged Matte Finish—Black”, <https://www.amazon.com/dp/B06W52JLH>, Earliest review date of Mar. 28, 2017, Downloaded on Jan. 16, 2020.

“Caseology Nero Tough for iPhone 8 Plus Case (2017) / iPhone 7 Plus Case (2016)—360 Protection—Black”, <https://www.amazon.com/dp/B07534JMM2>, Earliest review date of Aug. 23, 2017, Downloaded on Nov. 19, 2019.

“Spigen Rugged Armor Galaxy S6 Case with Resilient Shock Absorption and Carbon Fiber Design for Galaxy S6 2015—Black”, <https://www.amazon.com/dp/B00T6P05ZK>, Earliest review date of Mar. 10, 2015, Downloaded on Jul. 17, 2018.

(56)

References Cited

OTHER PUBLICATIONS

“Spigen Rugged Armor Galaxy S6 Edge Case with Flexible and Durable Shock Absorption with Carbon Fiber Design for Samsung Galaxy S6 Edge (2015)—Black”, <https://www.amazon.com/dp/B00SVCITW0>, Earliest review date of Mar. 13, 2015, Downloaded on Jul. 17, 2018.

“Spigen Rugged Armor Galaxy Note 5 Case with Resilient Shock Absorption and Carbon Fiber Design for Galaxy Note 5 2015—Black”, <https://www.amazon.com/dp/B010MWFUBY>, Earliest review date of Aug. 23, 2015, Downloaded on Jul. 17, 2018.

“Spigen Rugged Armor iPhone 6S Case with Resilient Shock Absorption and Carbon Fiber Design for iPhone 6S/iPhone 6—Black”, <https://www.amazon.com/dp/B010MVJM5K>, Earliest review date of Sep. 3, 2015, Downloaded on Jul. 17, 2018.

“Spigen Rugged Armor iPhone 6S Plus Case with Resilient Shock Absorption and Carbon Fiber Design for iPhone 6S Plus 2015—Black”, <https://www.amazon.com/dp/B010MVR76Q>, Earliest review date of Sep. 7, 2015, Downloaded on Jul. 17, 2018.

“Spigen Tough Armor Tech iPhone 6S Case with Extreme Shock and Drop Protection for Apple iPhone 6 / 6S—Gunmetal”, <https://www.amazon.com/Spigen-Tough-iPhone-Extreme-Protection/dp/B013TKNSIS>, Earliest review date of Oct. 3, 2015, Downloaded on Jan. 15, 2019.

“Spigen Rugged Armor Samsung Galaxy S7 Case with Resilient Shock Absorption and Carbon Fiber Design for Samsung Galaxy S7 2016—Black”, <https://www.amazon.com/Spigen-Rugged-Designed-Samsung-Galaxy/dp/B01A7ICWTQ>, Earliest review date of Feb. 25, 2016, Downloaded on Jul. 17, 2018.

“Spigen Rugged Armor Galaxy S7 Edge Case with Flexible and Durable Shock Absorption with Carbon Fiber Design for Samsung Galaxy S7 Edge (2016)—Black”, <https://www.amazon.com/Spigen-Rugged-Designed-Samsung-Galaxy/dp/B01A7IDHOU>, Earliest review date of Feb. 28, 2016, Downloaded on Jul. 17, 2018.

“Spigen Rugged Armor Galaxy A5 Case with Resilient Shock Absorption and Carbon Fiber Design for Galaxy A5—Black”, <https://www.amazon.com/Spigen-Rugged-Designed-Samsung-Galaxy/dp/B018J07A46>, Earliest review date of Mar. 18, 2016, Downloaded on Jul. 17, 2018.

“Spigen Rugged Armor iPhone SE Case with Resilient Shock Absorption and Carbon Fiber Design for iPhone SE 2016—Black”, <https://www.amazon.com/Spigen-Rugged-iPhone-Resilient-Absorption/dp/B01BEDNUDK>, Earliest review date of Apr. 10, 2016, Downloaded on Jan. 15, 2019.

“Spigen Rugged Armor Honor 5X Case with Resilient Shock Absorption and Carbon Fiber Design for Huawei Honor 5X—Black”, <https://www.amazon.com/Spigen-Rugged-Resilient-Absorption-Carbon/dp/B01DJHXXD2>, Earliest review date of May 1, 2016, Downloaded on Jan. 15, 2019.

“Spigen Rugged Armor HTC 10 Case with Resilient Shock Absorption and Carbon Fiber Design for HTC 10 2016—Black”, <https://www.amazon.com/dp/B01DAN1T4E>, Earliest review date of May 4, 2016, Downloaded on Jul. 18, 2018.

“Spigen Rugged Armor Huawei P8 Lite Case with Resilient Shock Absorption and Carbon Fiber Design for Huawei P8 Lite (2015)—Black”, <https://www.amazon.com/dp/B01DL0DME6>, Earliest review date of Jun. 1, 2016, Downloaded on Jul. 18, 2018.

“Spigen Rugged Armor OnePlus 3 Case/OnePlus 3T Case with Resilient Shock Absorption and Carbon Fiber Design for OnePlus 3 2016—Black”, <https://www.amazon.com/dp/B01H3PEWDK>, Earliest review date of Jul. 28, 2016, Downloaded on Jul. 17, 2018.

“Spigen Rugged Armor iPhone 8 Case / iPhone 7 Case with Resilient Shock Absorption and Carbon Fiber Design for Apple iPhone 8 (2017) / iPhone 7 (2016)—Black”, <https://www.amazon.co.uk/Spigen-Rugged-iPhone-Resilient-Absorption/dp/B01GIVX7TA>, Earliest review date of Aug. 2, 2016, downloaded on Oct. 24, 2018.

“Spigen Rugged Armor iPhone 8 Plus/iPhone 7 Plus Case with Resilient Shock Absorption and Carbon Fiber Design for Apple iPhone 8 Plus (2017)/iPhone 7 Plus (2016)—Black”, [\[amazon.com/dp/B01GIWGAAC\]\(https://www.amazon.com/dp/B01GIWGAAC\), Earliest review date of Sep. 2, 2016, Downloaded on Jul. 17, 2018.](https://www.</p>
</div>
<div data-bbox=)

“Spigen Rugged Armor Huawei P9 Lite Case with Resilient Shock Absorption and Carbon Fiber Design for Huawei P9 Lite—Black”, <https://www.amazon.com/B01DL0DJGM>, Earliest review date of Sep. 6, 2016, Downloaded on Jul. 18, 2018.

“Spigen Rugged Armor iPhone 8 Case/iPhone 7 Case with Resilient Shock Absorption and Carbon Fiber Design for Apple iPhone 8 (2017)/iPhone 7 (2016)—Black”, <https://www.amazon.com/dp/B01GIVX7TA>, Earliest review date of Sep. 11, 2016, Downloaded on Jul. 17, 2018.

“Spigen Rugged Armor Google Pixel XL Case with Resilient Shock Absorption and Carbon Fiber Design for Google Pixel XL 2016—Black”, <https://www.amazon.com/dp/B01M1EEXWJ>, Earliest review date of Oct. 2, 2016, Downloaded on Jul. 17, 2018.

“Spigen Rugged Armor LG V20 Case with Resilient Shock Absorption and Carbon Fiber Design for LG V20 2016—Black”, <https://www.amazon.com/dp/B01M0HW9P4>, Earliest review date of Oct. 19, 2016, Downloaded on Jul. 18, 2018.

“Spigen Rugged Armor Honor 8 Case with Resilient Shock Absorption for Huawei Honor 8 2016—Black”, <https://www.amazon.com/dp/B01LXTROW1>, Earliest review date of Oct. 20, 2016, Downloaded on Jul. 18, 2018.

“Spigen Rugged Armor Moto Z Droid Case with Resilient Shock Absorption and Carbon Fiber Design for Moto Z Droid 2016—Black”, <https://www.amazon.com/dp/B01HCAQMBQ>, Earliest review date of Dec. 9, 2016, Downloaded on Jul. 17, 2018.

“Spigen Rugged Armor Galaxy A3 2016 Case with Resilient Shock Absorption and Carbon Fiber Design for Galaxy A3 2016—Black”, <https://www.amazon.com/Spigen-Rugged-Armor-Samsung-Galaxy/dp/B01HFMYLIC>, Earliest review date of Dec. 18, 2016, Downloaded on Jul. 17, 2018.

“Spigen Rugged Armor ZenFone 3 Max Case (ZC520TL) with Resilient Shock Absorption and Carbon Fiber Design for ASUS ZenFone 3 Max (ZC520TL)—Black”, <https://www.amazon.com/dp/B01MSDJQ7C>, Earliest review date of Mar. 9, 2017, Downloaded on Jul. 18, 2018.

“Spigen Rugged Armor Extra Designed for LG G6 Case (2017) / Designed for LG G6 Plus (2017)—Black”, <https://www.amazon.com/Spigen-Rugged-Resilient-Absorption-Carbon/dp/B01N6T9PHS>, Earliest review date of Mar. 28, 2017, Downloaded on Jan. 9, 2020.

“Spigen Rugged Armor LG G6 Case/G6 Plus Case with Resilient Shock Absorption and Carbon Fiber Design for LG G6/G6 Plus (2017)—Black”, <https://www.amazon.com/dp/B01MUCZILA>, Earliest review date of Mar. 30, 2017, Downloaded on Jul. 18, 2018.

“Spigen Rugged Armor Galaxy S8 Plus Case with Resilient Shock Absorption and Carbon Fiber Design for Galaxy S8 Plus (2017)—Black”, <https://www.amazon.com/Spigen-Rugged-Designed-Samsung-Galaxy/dp/B06XNW4ZVJ>, Earliest review date of Apr. 3, 2017, Downloaded on Jul. 17, 2018.

“Spigen Rugged Armor Galaxy S8 Case with Resilient Shock Absorption and Carbon Fiber Design for Samsung Galaxy S8 (2017)—Black”, <https://www.amazon.com/Spigen-Rugged-Designed-Samsung-Galaxy/dp/B06XNNJ4KM>, Earliest review date of Apr. 7, 2017, Downloaded on Jul. 17, 2018.

Spigen, “Spigen Rugged Armor Extra”, <https://www.youtube.com/watch?v=ILUEjn1P2hk>, Published May 26, 2017, downloaded on Jan. 9, 2020.

“Spigen Rugged Armor Huawei P10 Plus Case with Resilient Shock Absorption and Carbon Fiber Design for Huawei P10 Plus(2017)—Rugged Armor”, <https://www.amazon.com/dp/B06XFZW779>, Earliest review date of May 26, 2017, Downloaded on Jul. 18, 2018.

“Spigen Rugged Armor Galaxy J7 2017 Case, J7 Prime, J7 2017(AT &T), J7 Sky Pro, J7 Perx case with Resilient Shock Absorption and Carbon Fiber Design for Samsung Galaxy J7 V 2017—Black”, <https://www.amazon.com/Spigen-Rugged-Resilient-Absorption-Samsung/dp/B06WRRF36B>, Earliest review date of May 31, 2017, Downloaded on Jan. 15, 2019.

“Spigen Rugged Armor Huawei P10 Lite Case with Resilient Shock Absorption and Carbon Fiber Design for Huawei P10 Lite (2017)—Black”, <https://www.amazon.com/dp/B06XCNQ3S4>, Earliest review date of Jun. 7, 2017, Downloaded on Jul. 18, 2018.

(56)

References Cited

OTHER PUBLICATIONS

“Spigen Rugged Armor Huawei P10 Case with Resilient Shock Absorption and Carbon Fiber Design for Huawei P10 (2017)—Black”, <https://www.amazon.com/dp/B06XCTQR1W>, Earliest review date of Jun. 8, 2017, Downloaded on Jul. 18, 2018.

“Spigen Rugged Armor HTC U11 Case with Resilient Shock Absorption and Carbon Fiber Design for HTC U 11 (2017)—Black”, <https://www.amazon.com/dp/B07234FLGX>, Earliest review date of Jun. 17, 2017, Downloaded on Jul. 18, 2018.

“Spigen Rugged Armor Huawei P8 Lite 2017 Case with Resilient Shock Absorption and Carbon Fiber Design for Huawei P8 Lite (2017)/nova lite/P9 lite 2017/Honor 8 lite—Black”, <https://www.amazon.com/dp/B06XFVXMLN>, Earliest review date of Jun. 24, 2017, Downloaded on Jul. 18, 2018.

“Spigen Rugged Armor Extra Galaxy Temp Case with Resilient Shock Absorption and Carbon Fiber Design for Galaxy Temp (2017)—Black”, <https://www.amazon.com/Spigen-Rugged-Galaxy-Resilient-Absorption/dp/B01MTEQVNB>, Earliest review date of Jul. 6, 2017, downloaded on Jan. 9, 2020.

“Spigen Rugged Armor Sony Xperia XZ Premium Case with Resilient Shock Absorption and Carbon Fiber Design for Sony Xperia XZ Premium (2017)—Black”, <https://www.amazon.com/dp/B072PRXPQC>, Earliest review date of Jul. 14, 2017, Downloaded on Jul. 18, 2018.

“Spigen Rugged Armor OnePlus 5 Case with Resilient Shock Absorption and Carbon Fiber Design for OnePlus 5 (2017)—Black”, <https://www.amazon.com/dp/B06XG19W3G>, Earliest review date of Jul. 25, 2017, Downloaded on Jul. 17, 2018.

“Spigen Rugged Armor Moto Z2 Play Case with Resilient Shock Absorption and Carbon Fiber Design for Moto Z2 Play—Black”, <https://www.amazon.com/dp/B071WR4H9V>, Earliest review date of Jul. 27, 2017, Downloaded on Jul. 17, 2018.

“Spigen Rugged Armor Galaxy Note 8 Case with Resilient Shock Absorption and Carbon Fiber Design for Galaxy Note 8 (2017)—Matte Black”, <https://www.amazon.com/Spigen-Rugged-Galaxy-Resilient-Absorption/dp/B073RWJ6Z7>, Earliest review date of Aug. 26, 2017, Downloaded on Jan. 15, 2019.

“Spigen Rugged Armor Galaxy Note 8 Case with Resilient Shock Absorption and Carbon Fiber Design for Galaxy Note 8 (2017)—Matte Black”, <https://www.amazon.com/Spigen-Rugged-Designed-Samsung-Galaxy/dp/B073RWJ6Z7>, Earliest review date of Aug. 26, 2017, Downloaded on Jul. 17, 2018.

“Spigen Rugged Crystal Designed for Samsung Galaxy Note 8 Case (2017)—Crystal Clear”, <https://www.amazon.com/Spigen-Rugged-Crystal-Designed-Samsung/dp/B073RWTZ5M>, Earliest review date of Aug. 30, 2017, downloaded on Jan. 9, 2020.

“Spigen Rugged Armor Moto E4 Case with Resilient Shock Absorption and Carbon Fiber Design for Moto E4 (2017)—Black”, <https://www.amazon.com/Spigen-Rugged-Armor-Designed-Motorola/dp/B073RVC6YY>, Earliest review date of Sep. 5, 2017, Downloaded on Jul. 17, 2018.

“Spigen Rugged Armor Extra Designed for Apple iPhone 7 Case (2016)—Black”, <https://www.amazon.com/Spigen-Rugged-iPhone-Resilient-Absorption/dp/B06XC8WL7P>, Earliest review date of Sep. 7, 2017, downloaded on Jan. 9, 2020.

* cited by examiner

FIG. 1

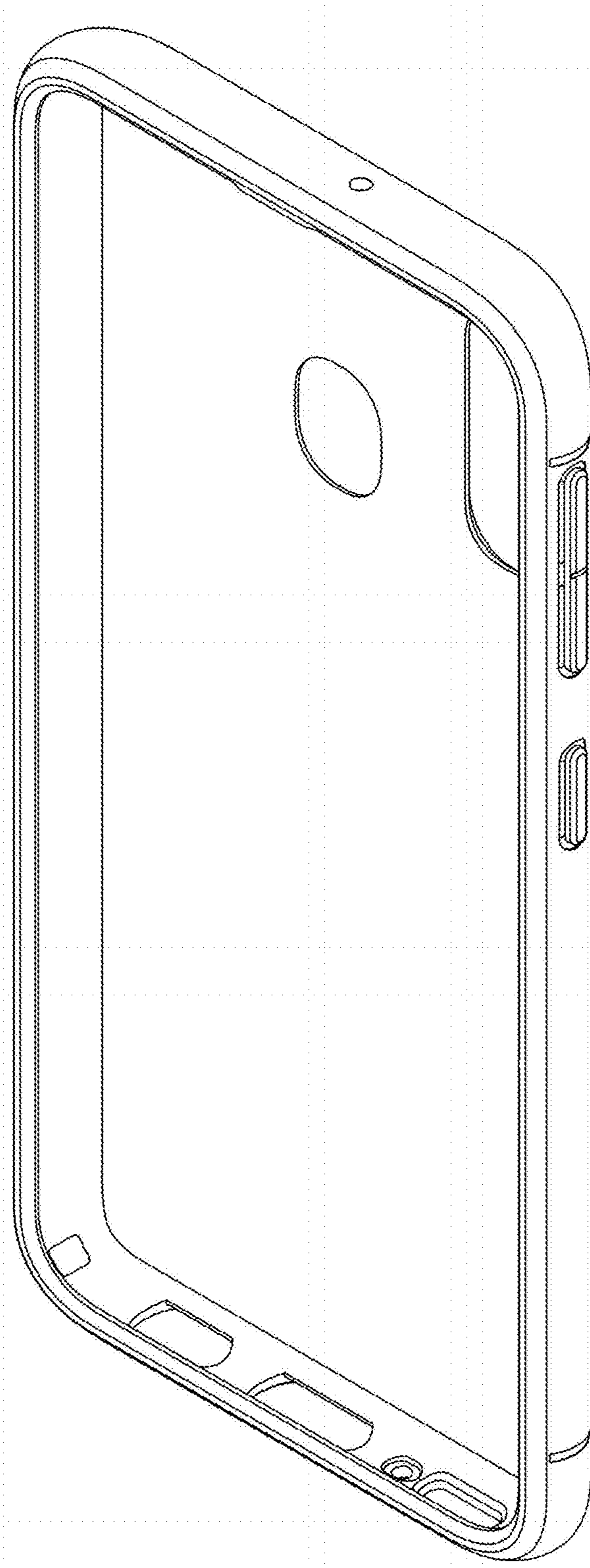

FIG. 2

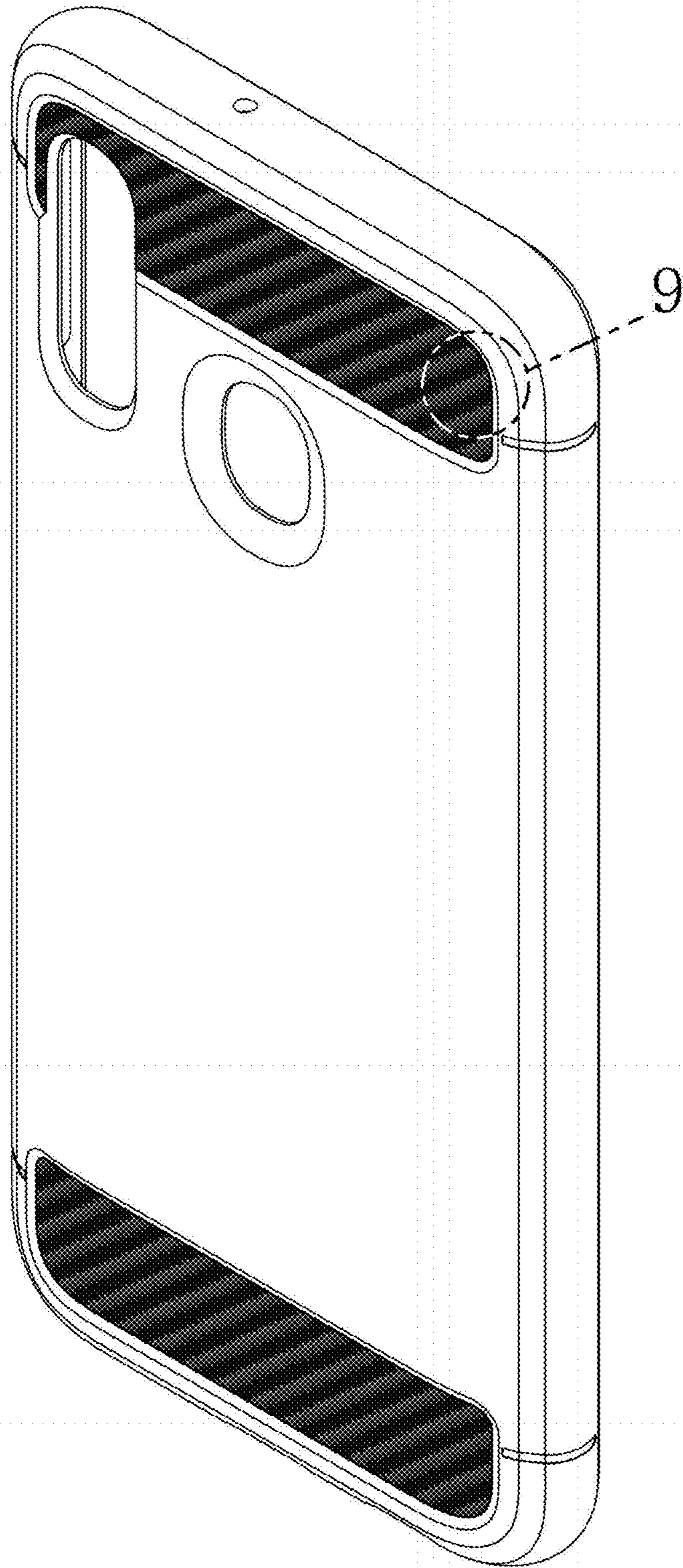

FIG. 3

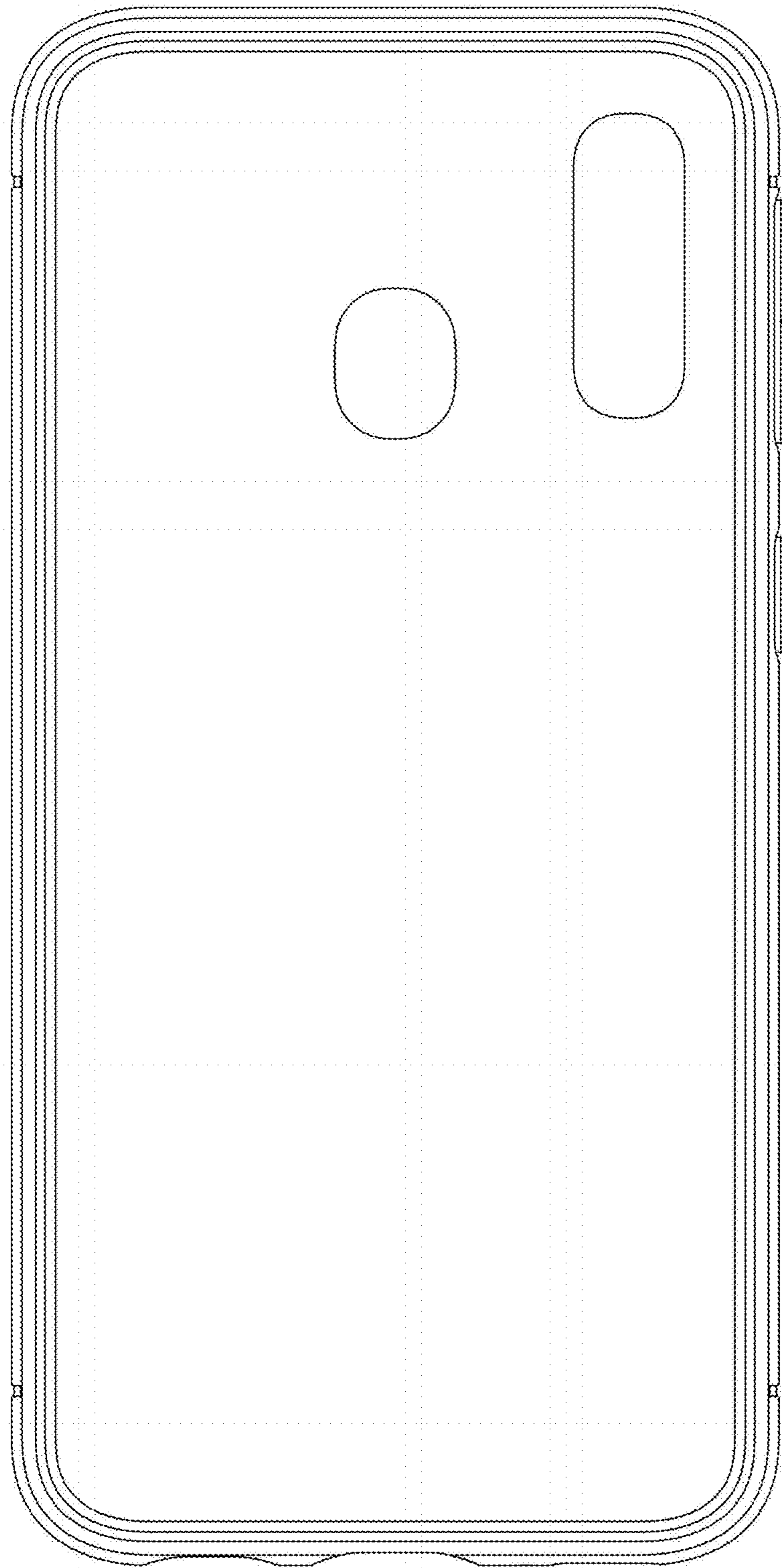

FIG. 4

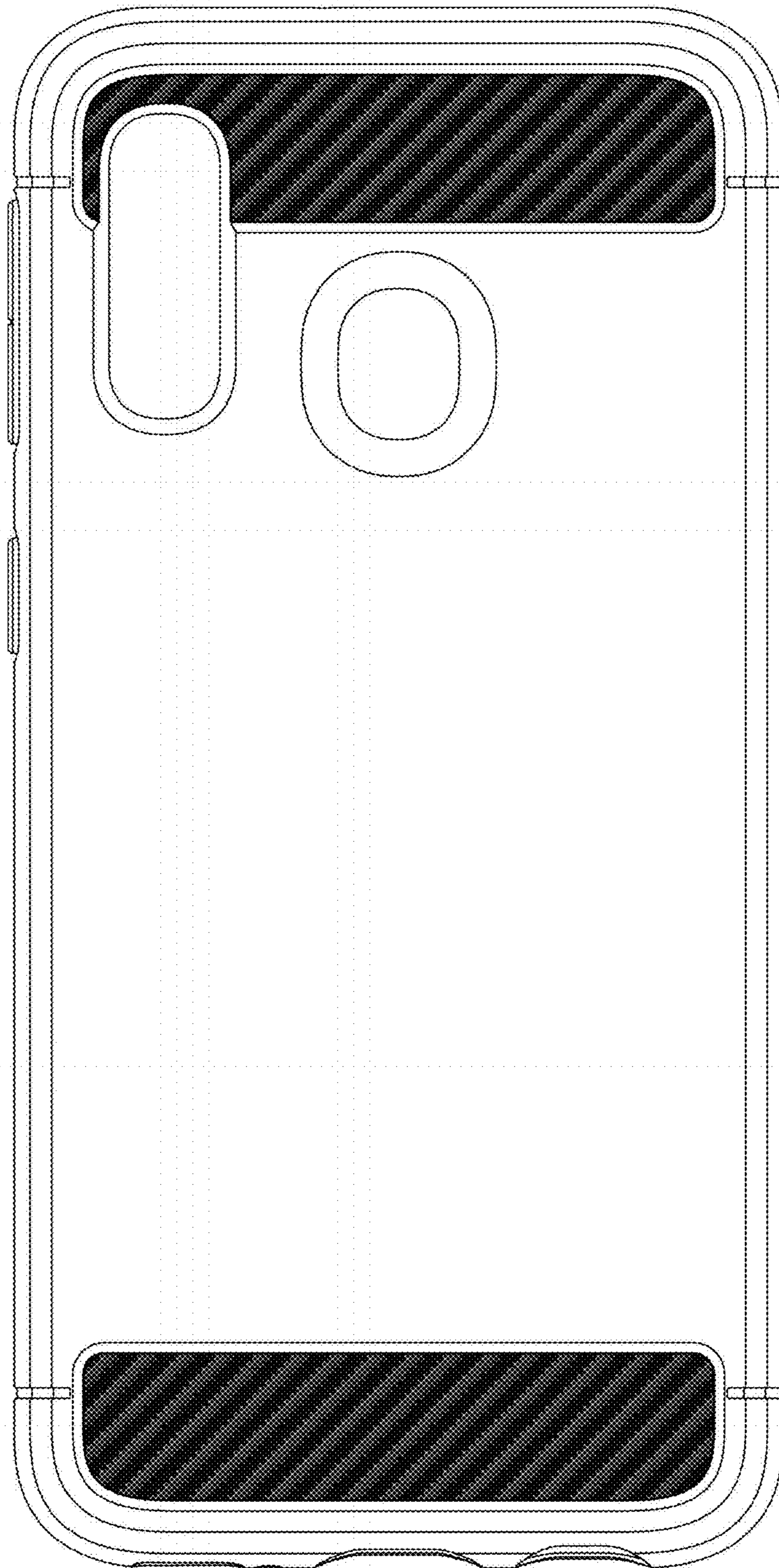

FIG. 5

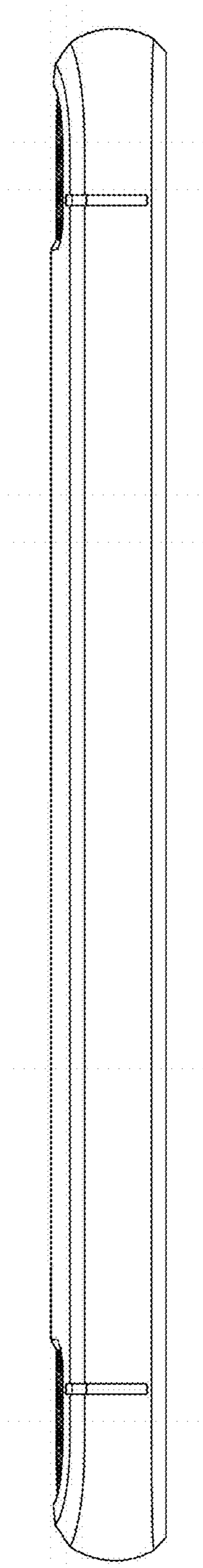

FIG. 6

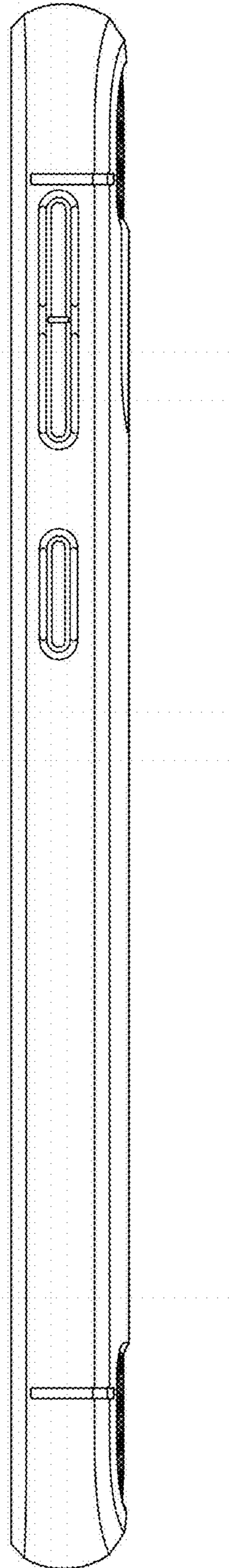

FIG. 7

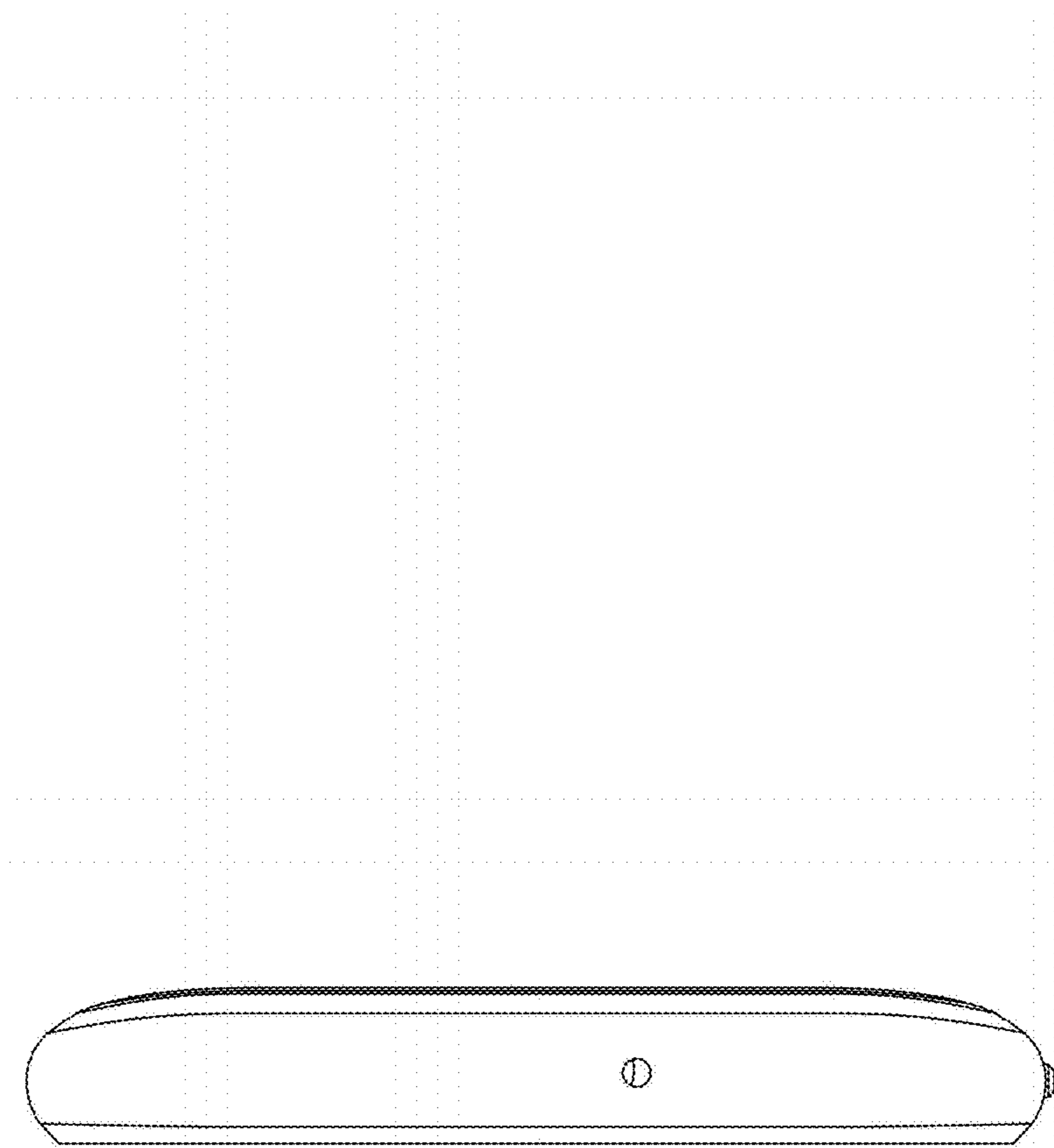

FIG. 8

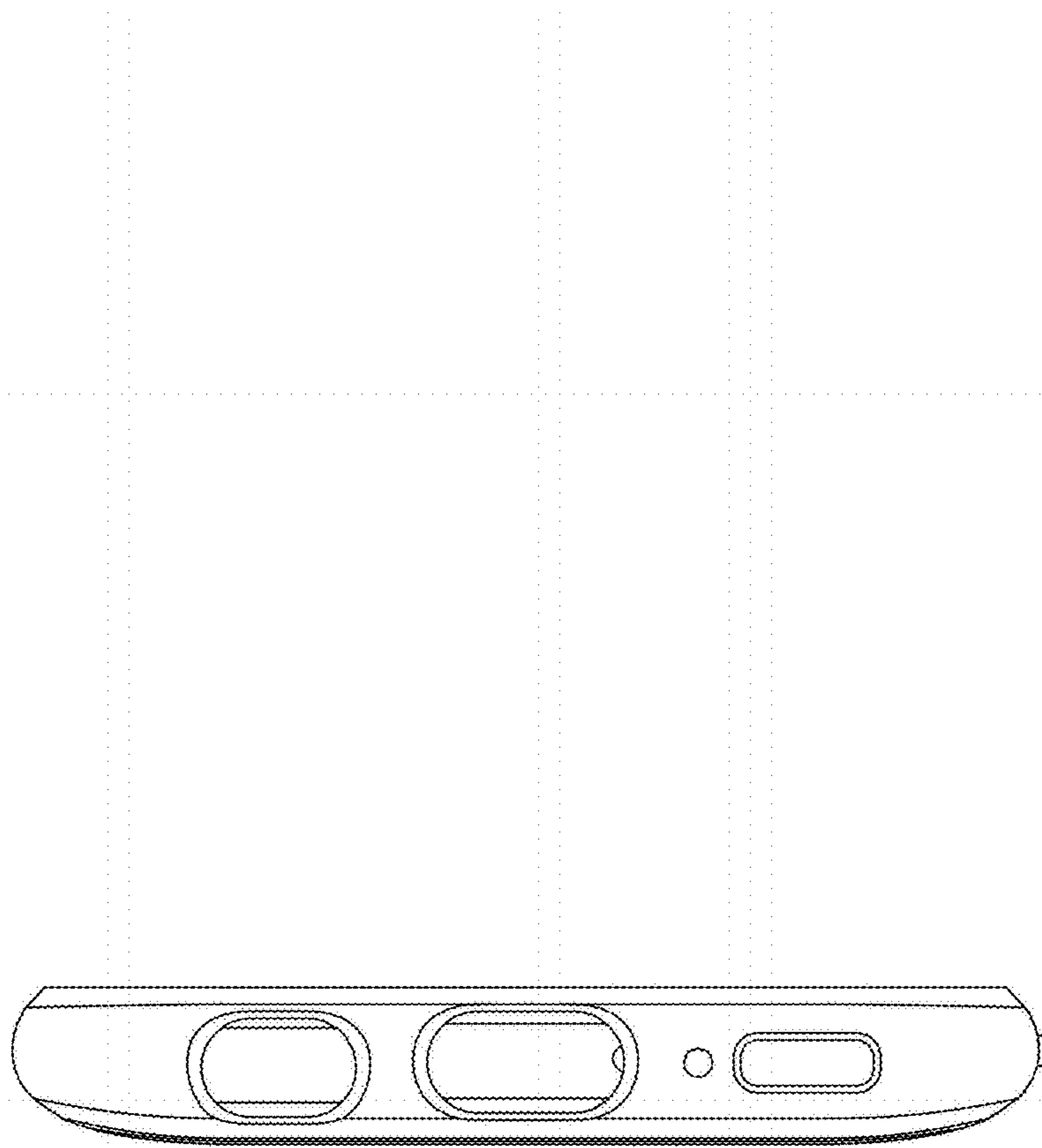

FIG. 9

