



US00D927438S

(12) **United States Design Patent** (10) **Patent No.:** **US D927,438 S**
Fossion (45) **Date of Patent:** **** Aug. 10, 2021**

(54) **HOUSING FOR ELECTRONIC MODULES**

(56) **References Cited**

(71) Applicant: **THALES ALENIA SPACE FRANCE,**
Cannes la Bocca (FR)

U.S. PATENT DOCUMENTS

(72) Inventor: **Marc Fossion,** Ligny (BE)

D399,191 S *	10/1998	Corrington	D14/312
D416,872 S *	11/1999	Burke	D13/182
D544,866 S *	6/2007	Wang	D14/438
D564,521 S *	3/2008	Liu	D14/433
D632,299 S *	2/2011	King	D14/438
D722,577 S *	2/2015	Zimmer	D13/179
D831,596 S *	10/2018	Franck	D13/184
D832,211 S *	10/2018	Ladd	D13/110
D895,561 S *	9/2020	Xiang	D13/184
D896,191 S *	9/2020	Xiang	D13/184

(**) Term: **15 Years**

(21) Appl. No.: **35/509,180**

(22) Filed: **Sep. 9, 2019**

* cited by examiner

(80) **Hague Agreement Data**

Int. Filing Date: **Sep. 9, 2019**

Int. Reg. No.: **DM/207341**

Int. Reg. Date: **Sep. 9, 2019**

Int. Reg. Pub. Date: **Apr. 24, 2020**

Primary Examiner — Bao-Yen T Nguyen

(57) **CLAIM**

The ornamental design for a housing for electronic modules, as shown and described.

(51) **LOC (13) Cl.** **13-03**

(52) **U.S. Cl.**

USPC **D13/184**; 110/123

DESCRIPTION

(58) **Field of Classification Search**

USPC D14/300–304, 308–314, 328, 348–370,
D14/432, 435, 440, 441, 443–446,
D14/479–483; D13/123, 133, 146, 147,
D13/152, 154, 155, 158, 164, 184, 199,
D13/110

The patent or application file contains at least one drawing executed in color. Copies of this patent or patent application publication with color drawing(s) will be provided by the Office upon request and payment of the necessary fee.

1. Housing for electronic modules

1.1 : Top

1.2 : Bottom

1.3 : Front

1.4 : Left

1.5 : Right

1.6 : Bottom view in perspective

1.7 : Top view in perspective

CPC G02B 6/3897; G02B 6/3887; G02B
6/4256–4257; G02B 6/426; G02B 6/4262;
G02B 6/4441; G02B 6/4446; G02B
6/4447; G02B 6/445; G02B 6/4452–4453;
G02B 6/4472; G02B 6/4455; G02B
6/4453; G02B 7/00

See application file for complete search history.

1 Claim, 7 Drawing Sheets
(5 of 7 Drawing Sheet(s) Filed in Color)

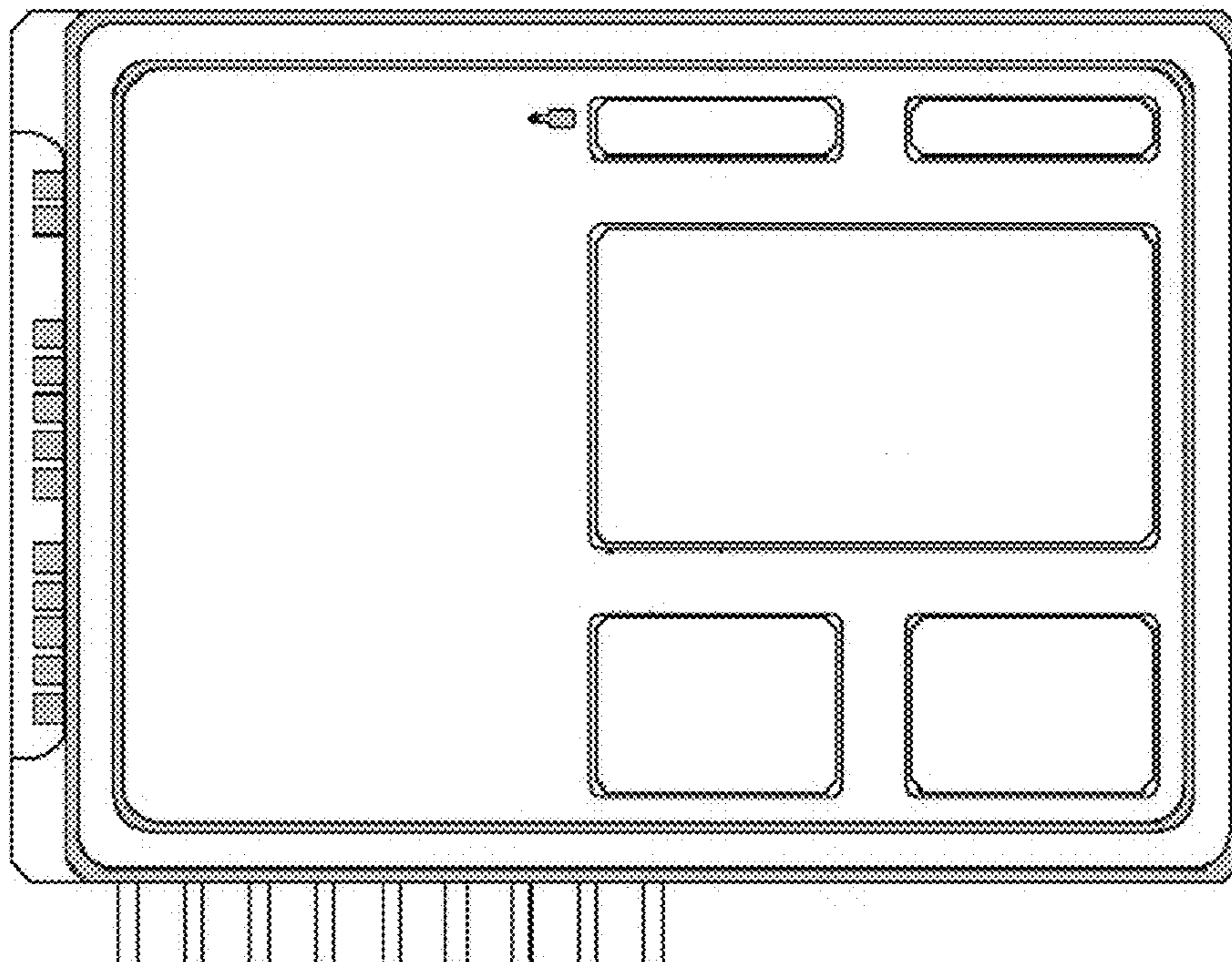

1.1

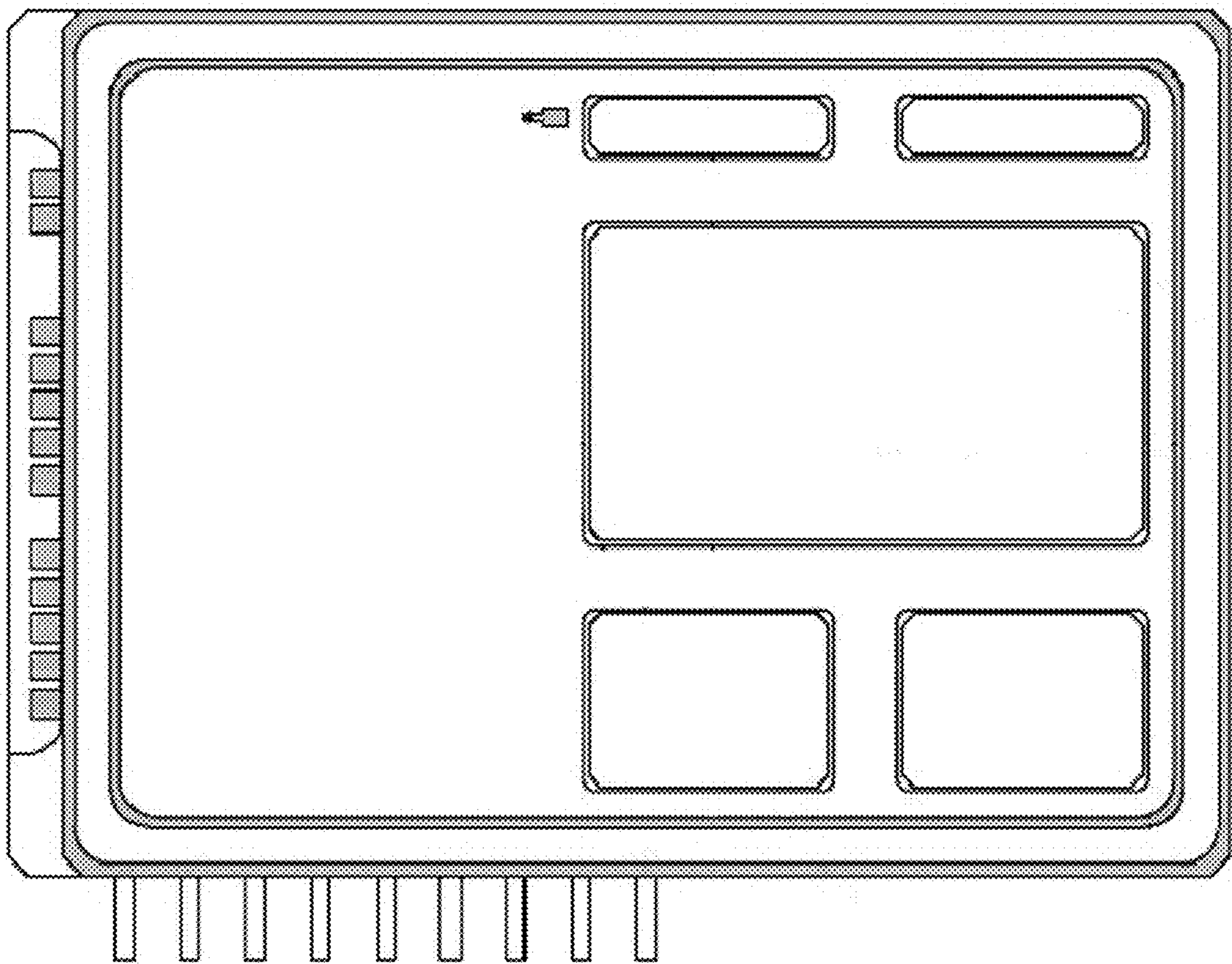

1.2

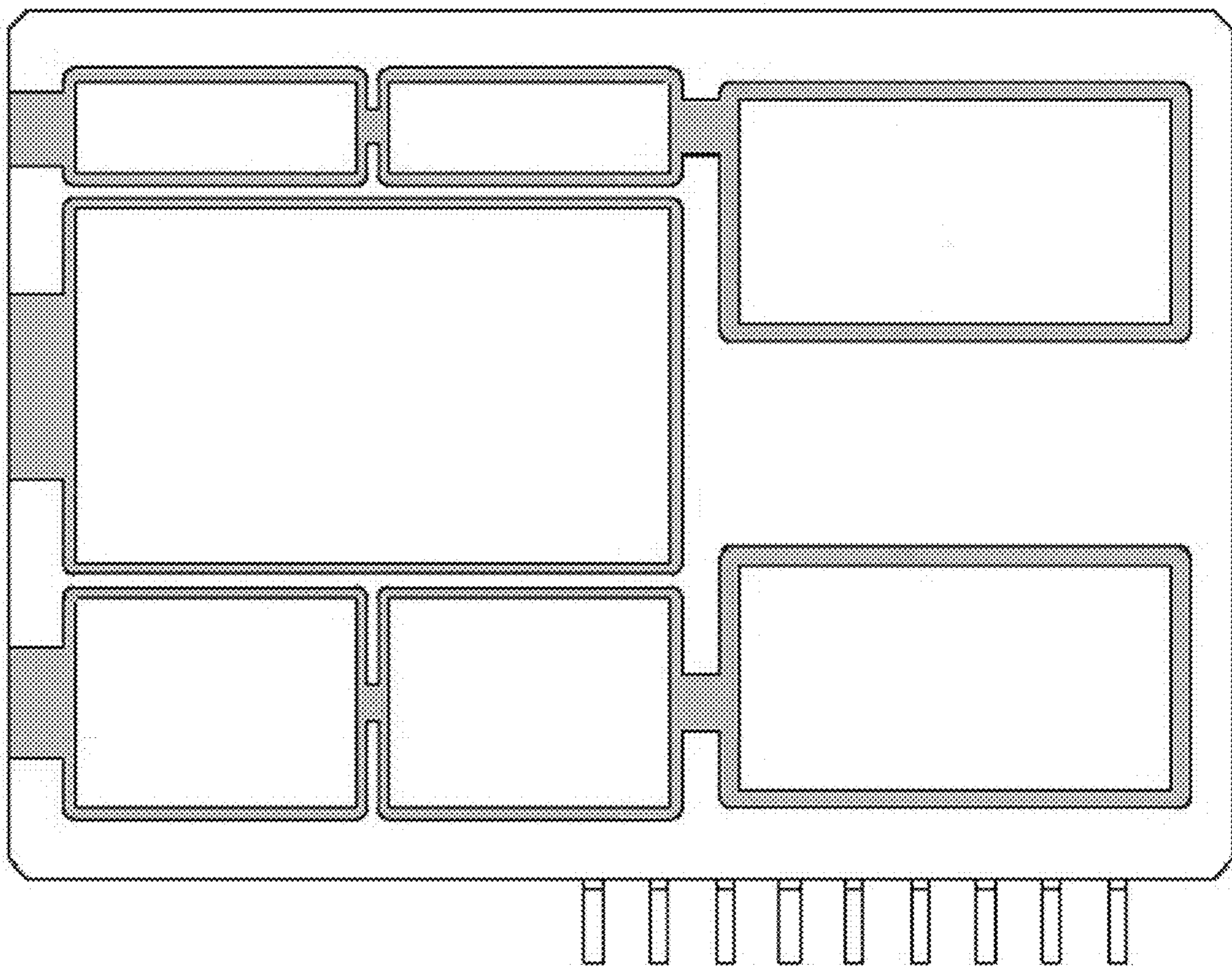

1.3

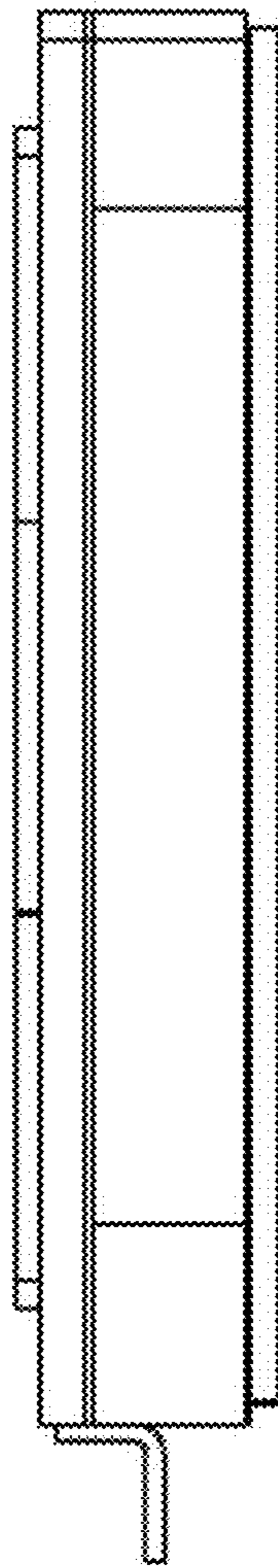

1.4

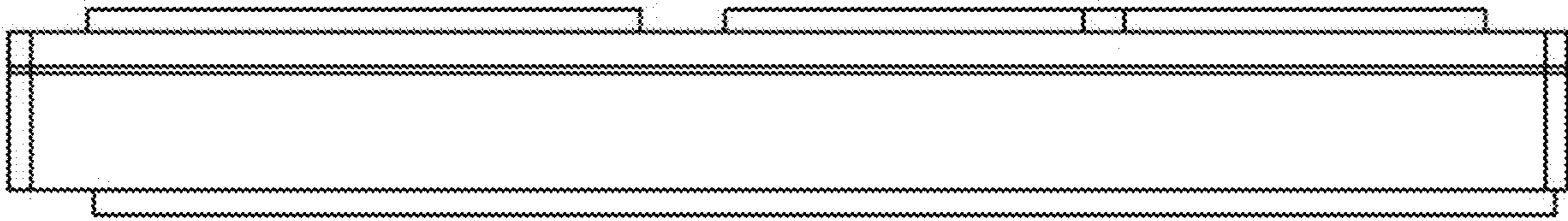

1.5

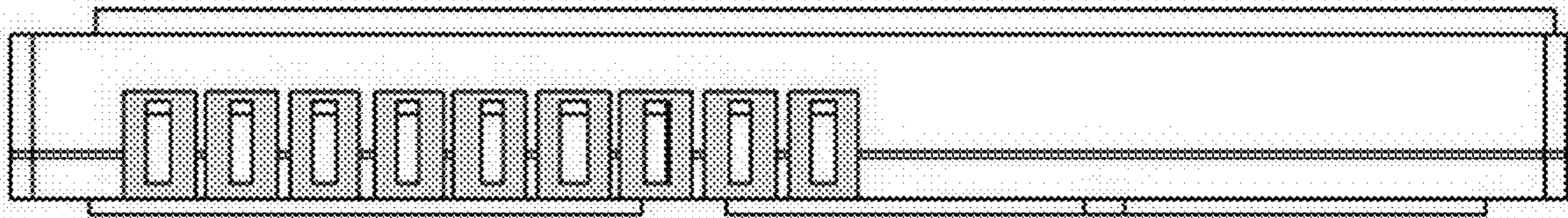

1.6

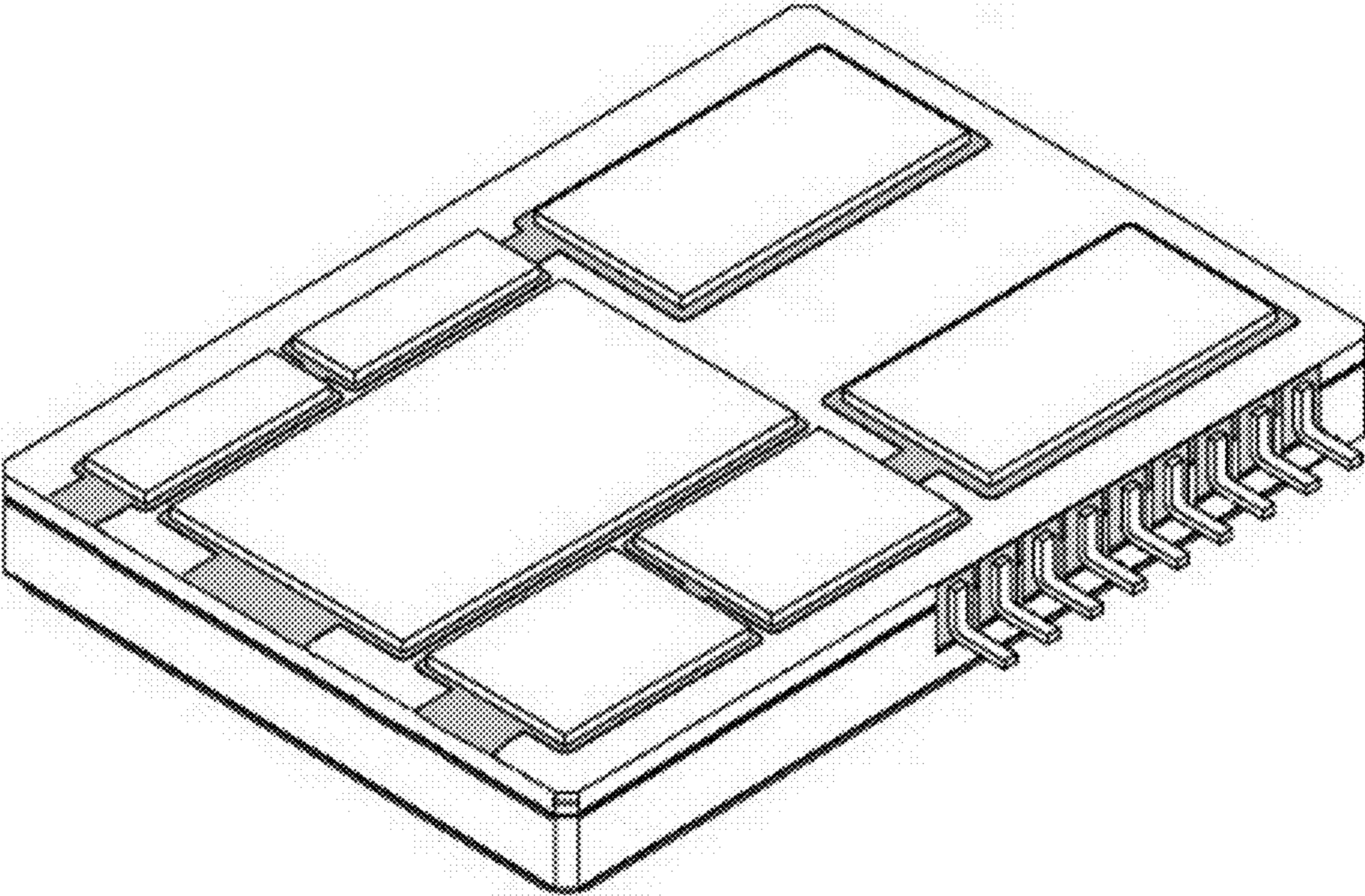

1.7

