



US00D927359S

(12) **United States Design Patent**  
**Manzoni**

(10) **Patent No.:** **US D927,359 S**

(45) **Date of Patent:** **\*\* Aug. 10, 2021**

(54) **MOTOR CAR**

(71) Applicant: **FERRARI S.p.A.**, Modena (IT)

(72) Inventor: **Flavio Manzoni**, Maranello (IT)

(73) Assignee: **FERRARI S.p.A.**, Modena (IT)

(\*\*) Term: **15 Years**

(21) Appl. No.: **35/508,799**

(22) Filed: **Sep. 13, 2019**

(80) **Hague Agreement Data**

Int. Filing Date: **Sep. 13, 2019**  
Int. Reg. No.: **DM/204298**  
Int. Reg. Date: **Sep. 13, 2019**  
Int. Reg. Pub. Date: **Mar. 13, 2020**

(30) **Foreign Application Priority Data**

Mar. 15, 2019 (EM) ..... 006307054

(51) **LOC (13) Cl.** ..... **12-08**

(52) **U.S. Cl.**  
USPC ..... **D12/92**

(58) **Field of Classification Search**

USPC ..... D12/86, 88, 90-92, 184, 196; D21/424,  
D21/433, 434, 533, 548  
CPC ..... B62D 25/00; B62D 25/02; B62D 25/06;  
B62D 35/00; B62D 35/005; B60J 5/04  
See application file for complete search history.

(56) **References Cited**

**U.S. PATENT DOCUMENTS**

D526,599 S \* 8/2006 Moruzzi ..... D12/92  
D576,523 S \* 9/2008 Battams ..... D12/88

D774,415 S \* 12/2016 Menegon ..... D12/88  
D801,227 S \* 10/2017 Stephenson ..... D12/88  
D801,871 S \* 11/2017 Manzoni ..... D12/92  
D813,095 S \* 3/2018 Manzoni ..... D12/88  
D826,092 S \* 8/2018 Manzoni ..... D12/92  
D827,494 S \* 9/2018 Manzoni ..... D12/88  
D830,901 S \* 10/2018 Manzoni ..... D12/88  
D830,902 S \* 10/2018 Manzoni ..... D12/88  
D833,912 S \* 11/2018 Manzoni ..... D12/88  
D870,823 S \* 12/2019 Manzoni ..... D21/548  
D885,256 S \* 5/2020 Manzoni ..... D12/88  
D897,901 S \* 10/2020 Anscheidt ..... D12/88  
D899,303 S \* 10/2020 Hilton ..... D12/88  
D902,784 S \* 11/2020 Manzoni ..... D12/92  
D904,230 S \* 12/2020 Wang ..... D12/92

\* cited by examiner

*Primary Examiner* — George D. Kirschbaum  
*Assistant Examiner* — Calvin E Vansant  
(74) *Attorney, Agent, or Firm* — Cowan, Liebowitz &  
Latman, P.C.; Anastasia Zhadina

(57) **CLAIM**

The ornamental design for a motor car, as shown and described.

**DESCRIPTION**

- 1. Motor car
- 1.1 : Front perspective view
- 1.2 : Rear perspective view
- 1.3 : Front
- 1.4 : Back
- 1.5 : Lateral view
- 1.6 : Top plan view

The broken lines depict portions of the motor car that form no part of the claimed design.

**1 Claim, 6 Drawing Sheets**

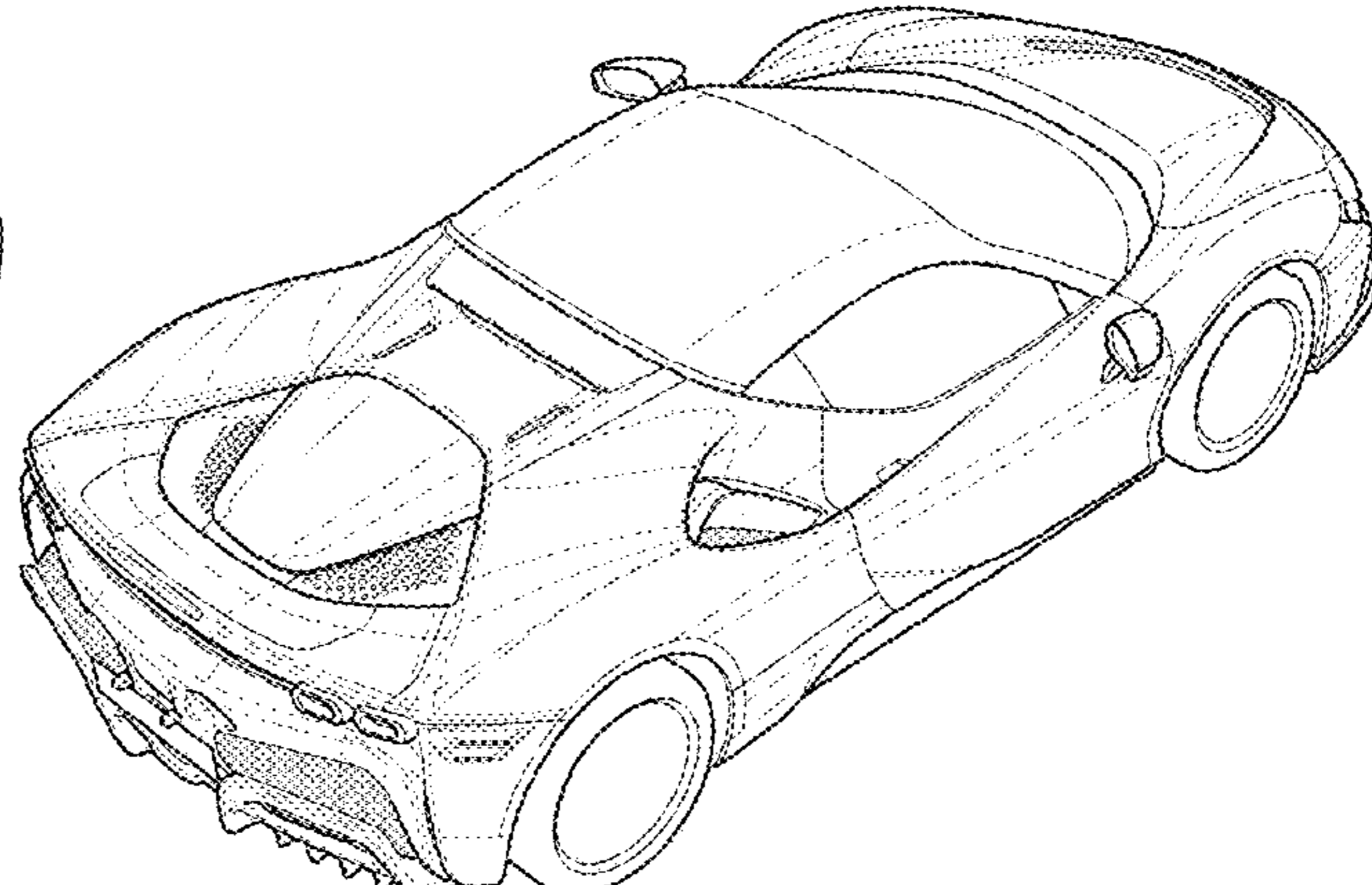
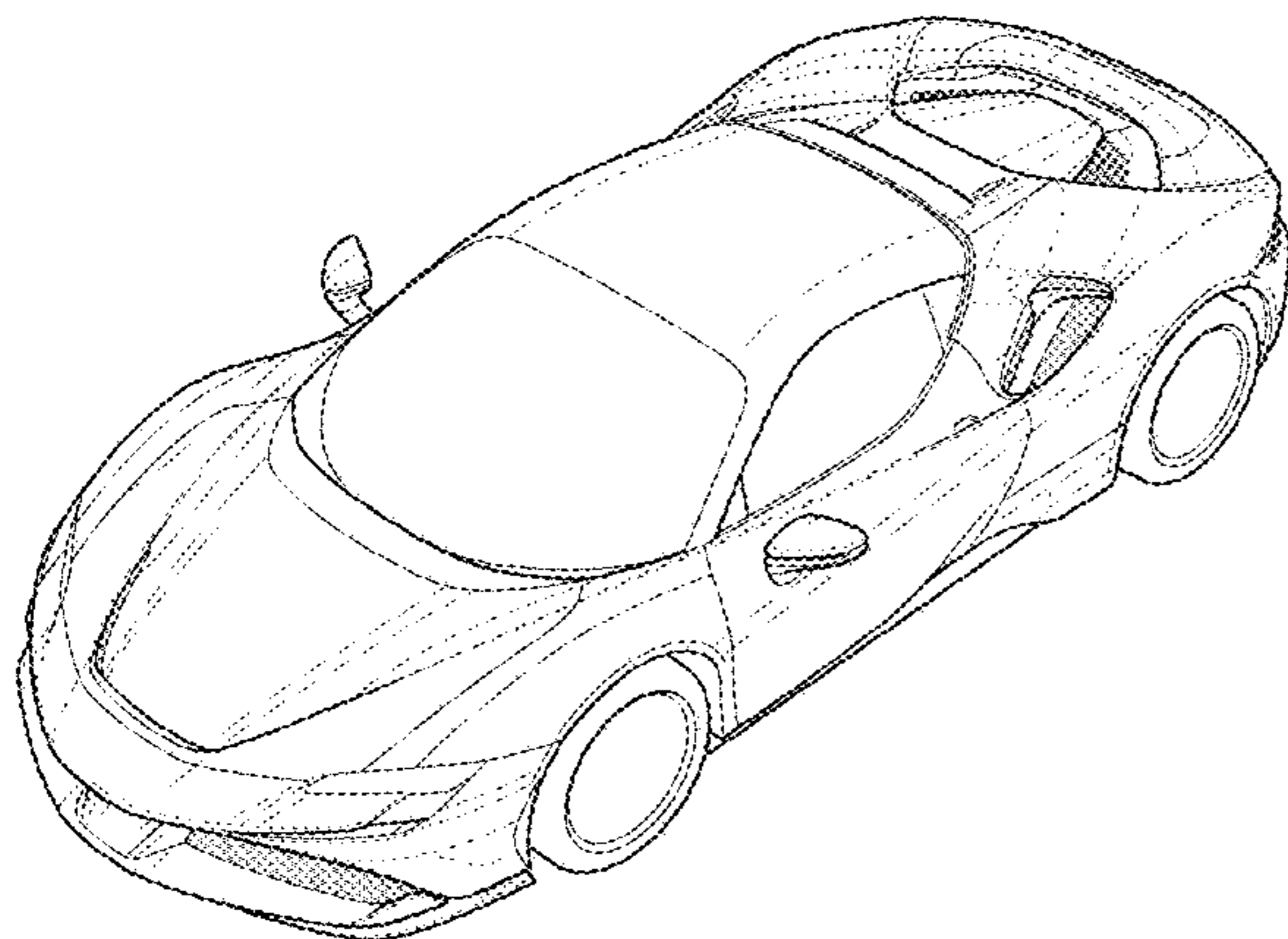

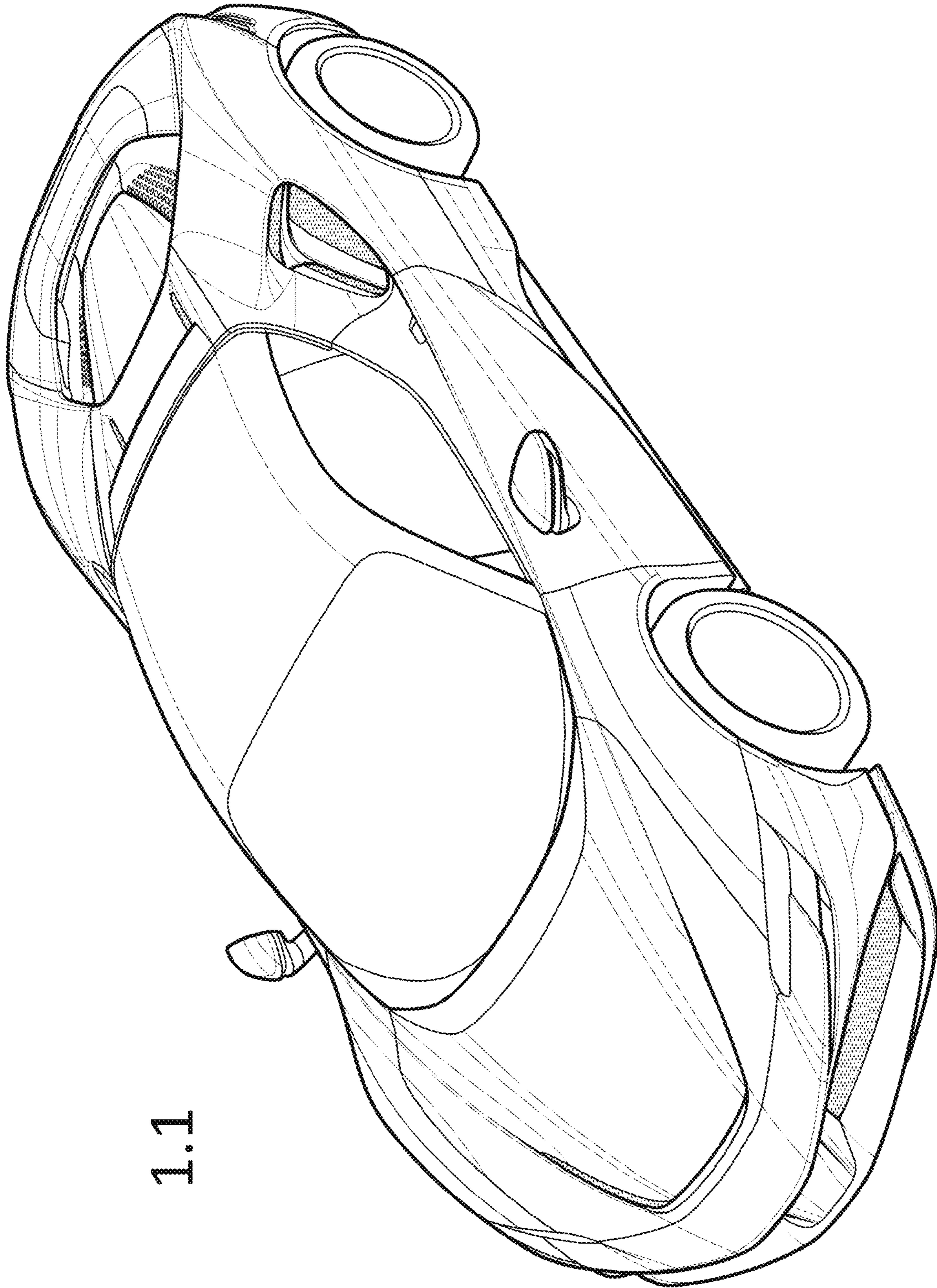

1.1



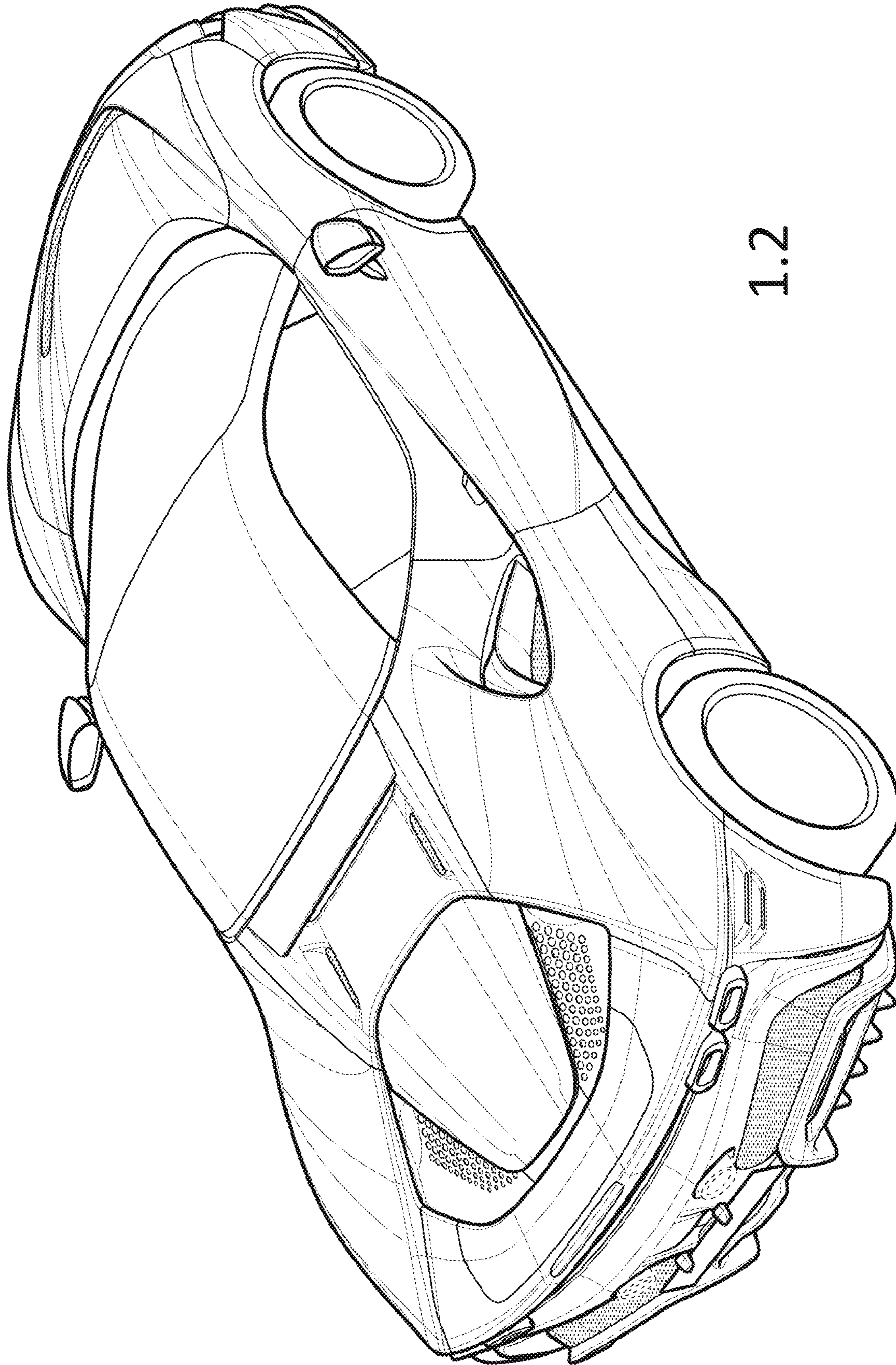

1.2

1.3

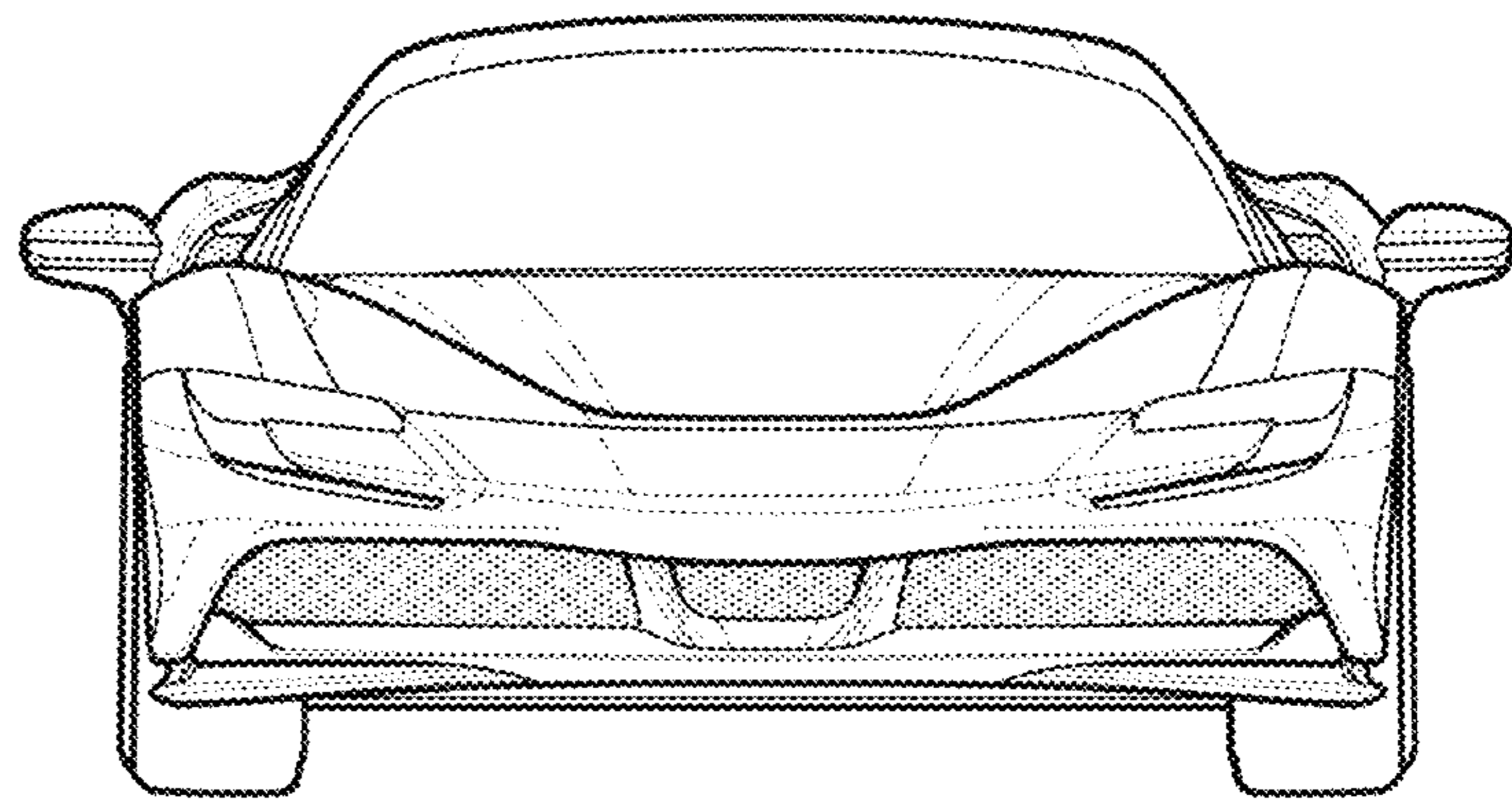

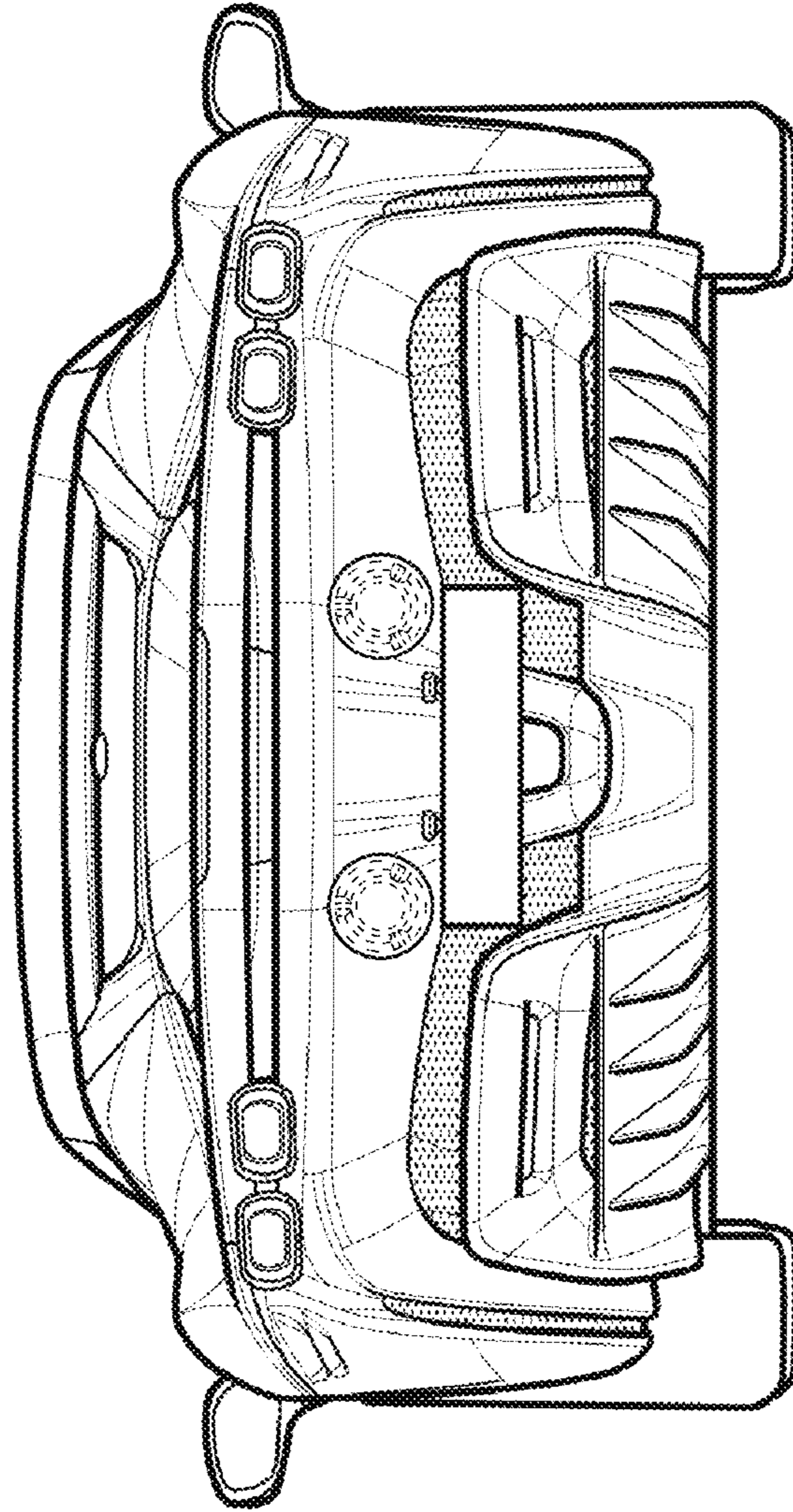

1.4



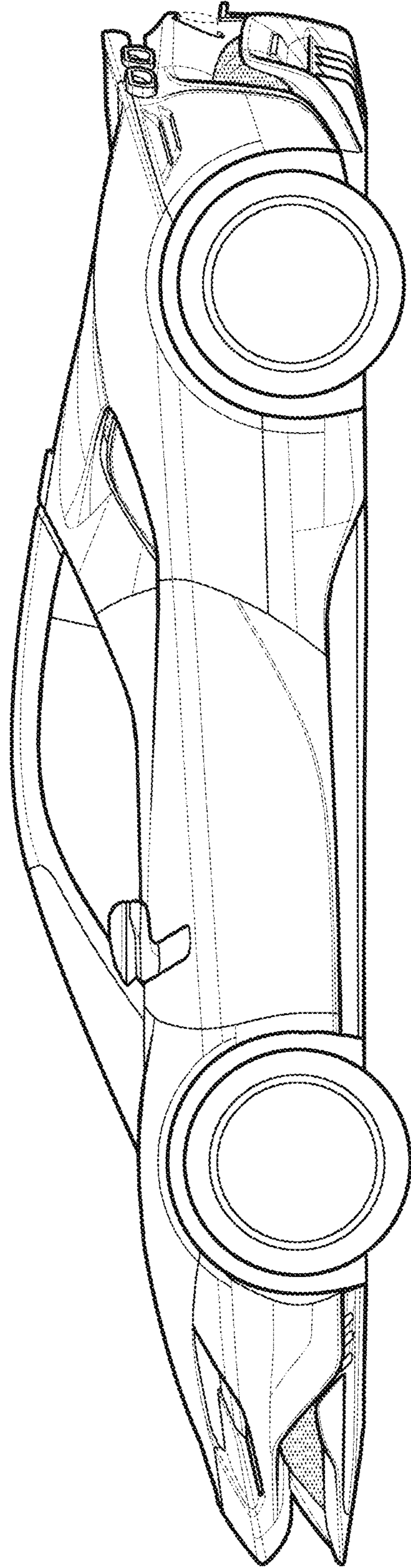

1.5

1.6

