



US00D927286S

(12) **United States Design Patent**
Masters

(10) **Patent No.:** **US D927,286 S**

(45) **Date of Patent:** **** Aug. 10, 2021**

(54) **DOOR PLATE COVER**

(71) Applicant: **Aaron Masters**, Dallas, TX (US)

(72) Inventor: **Aaron Masters**, Dallas, TX (US)

(**) Term: **15 Years**

(21) Appl. No.: **29/707,711**

(22) Filed: **Sep. 30, 2019**

Related U.S. Application Data

(63) Continuation-in-part of application No. 29/705,209, filed on Sep. 10, 2019.

(51) **LOC (13) Cl.** **08-07**

(52) **U.S. Cl.**
USPC **D8/346**

(58) **Field of Classification Search**
USPC D8/346
CPC E05B 15/02; E05B 15/0205; E05B 15/021
See application file for complete search history.

(56) **References Cited**

U.S. PATENT DOCUMENTS

7,128,350 B2 * 10/2006 Eckerdt E05B 53/001
292/341.16
D544,782 S * 6/2007 Kershaw D8/346

D549,079 S * 8/2007 Killins D8/346
D557,587 S * 12/2007 Navin D8/346
9,340,996 B2 * 5/2016 Nelson E05B 15/0245
9,765,550 B2 * 9/2017 Hemmingsen E05B 65/00

* cited by examiner

Primary Examiner — Doris Clark
(74) *Attorney, Agent, or Firm* — Law Office of Jeff Williams PLLC; J. Oliver Williams

(57) **CLAIM**

The ornamental design for a door plate cover, as shown.

DESCRIPTION

FIG. 1 is an oblique view of a door plate cover according to the present application.

FIG. 2 is an alternate oblique view of the door plate cover of FIG. 1.

FIG. 3 is a front view of the door plate cover of FIG. 1.

FIG. 4 is a rear view of the door plate cover of FIG. 1.

FIG. 5 is a right view of the door plate cover of FIG. 1.

FIG. 6 is a left view of the door plate cover of FIG. 1.

FIG. 7 is a top view of the door plate cover of FIG. 1.

FIG. 8 is a bottom view of the door plate cover of FIG. 1; and,

FIG. 9 is a section view of the door plate cover taken along lines 9-9 of FIG. 8.

1 Claim, 7 Drawing Sheets

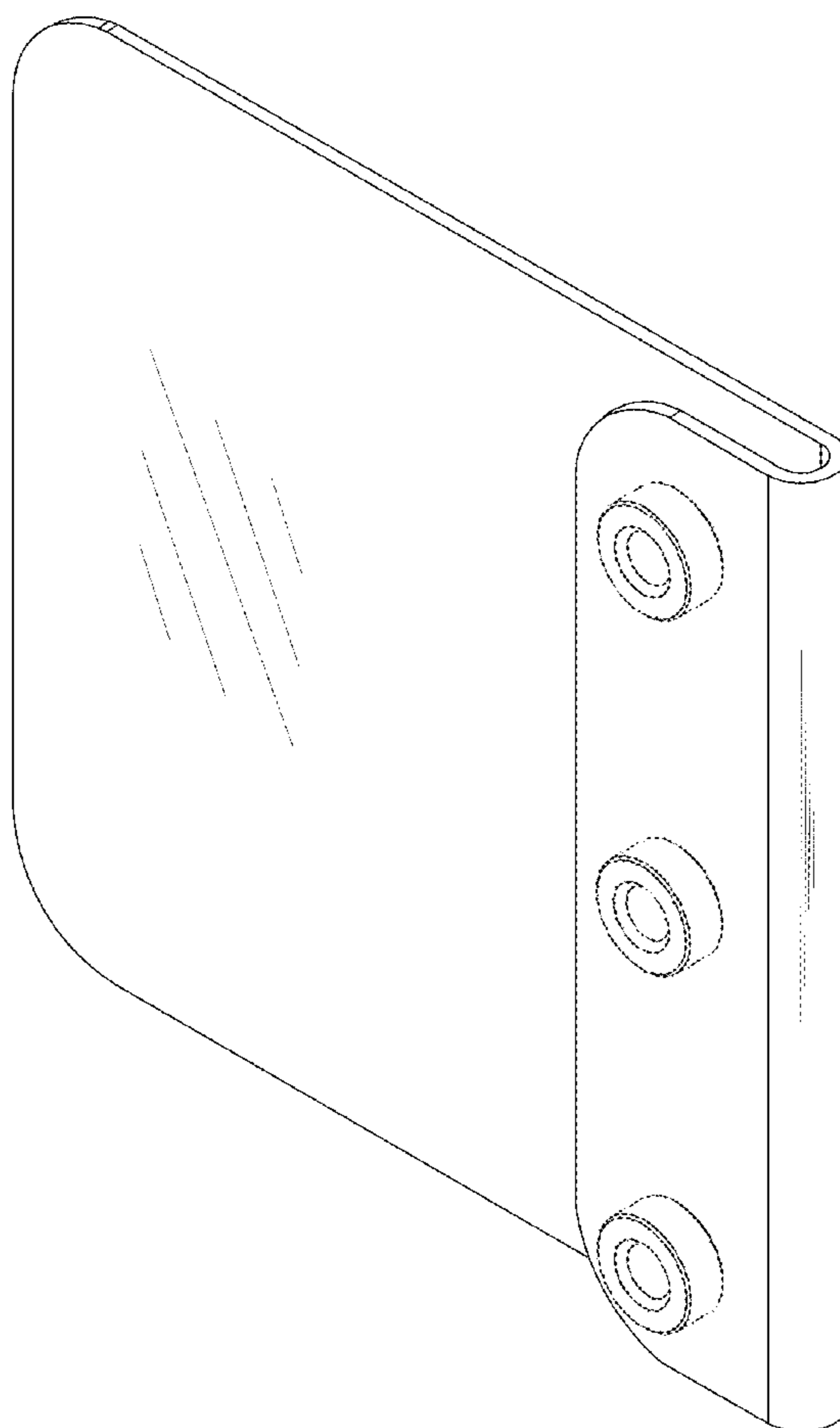

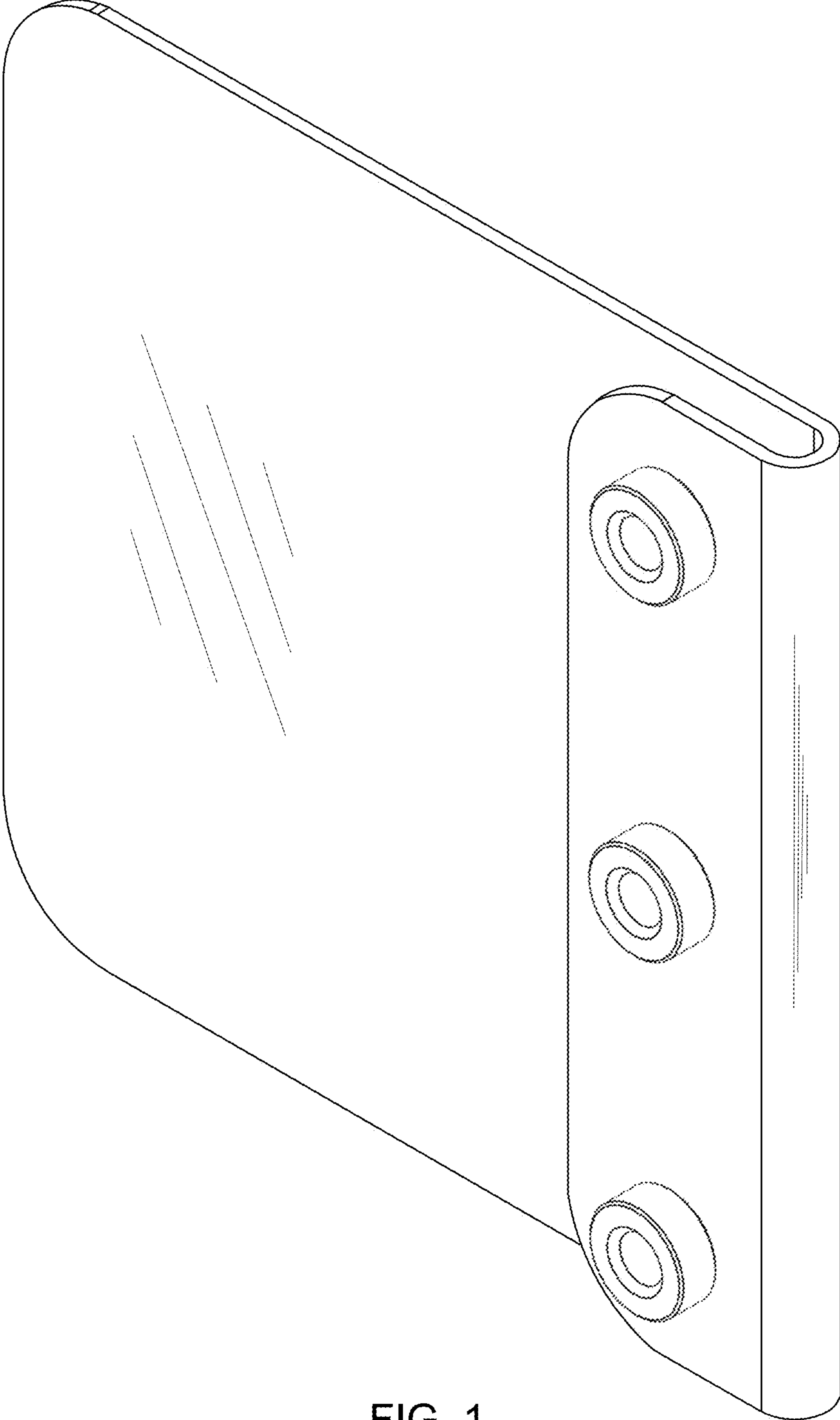

FIG. 1

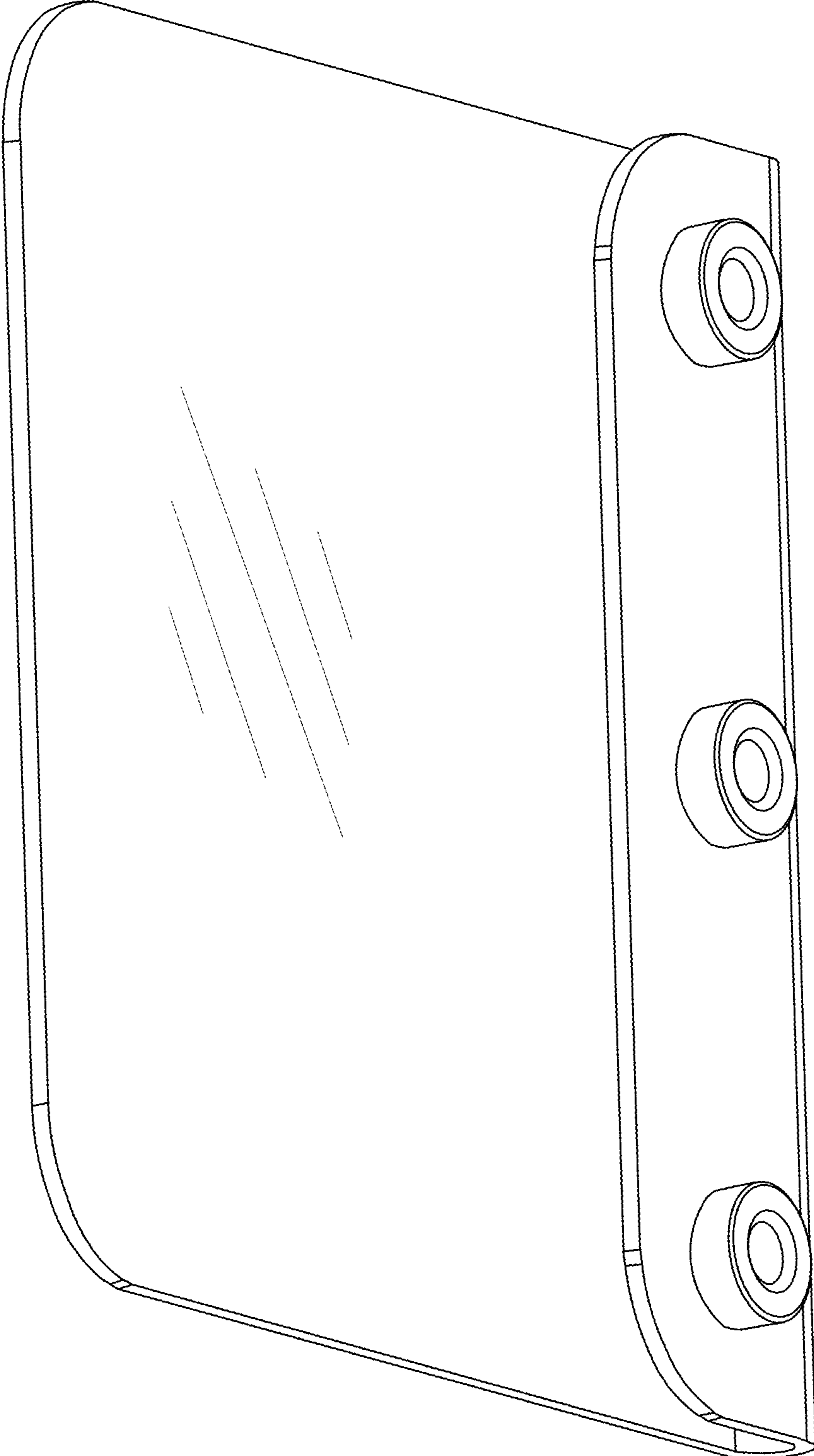

FIG. 2

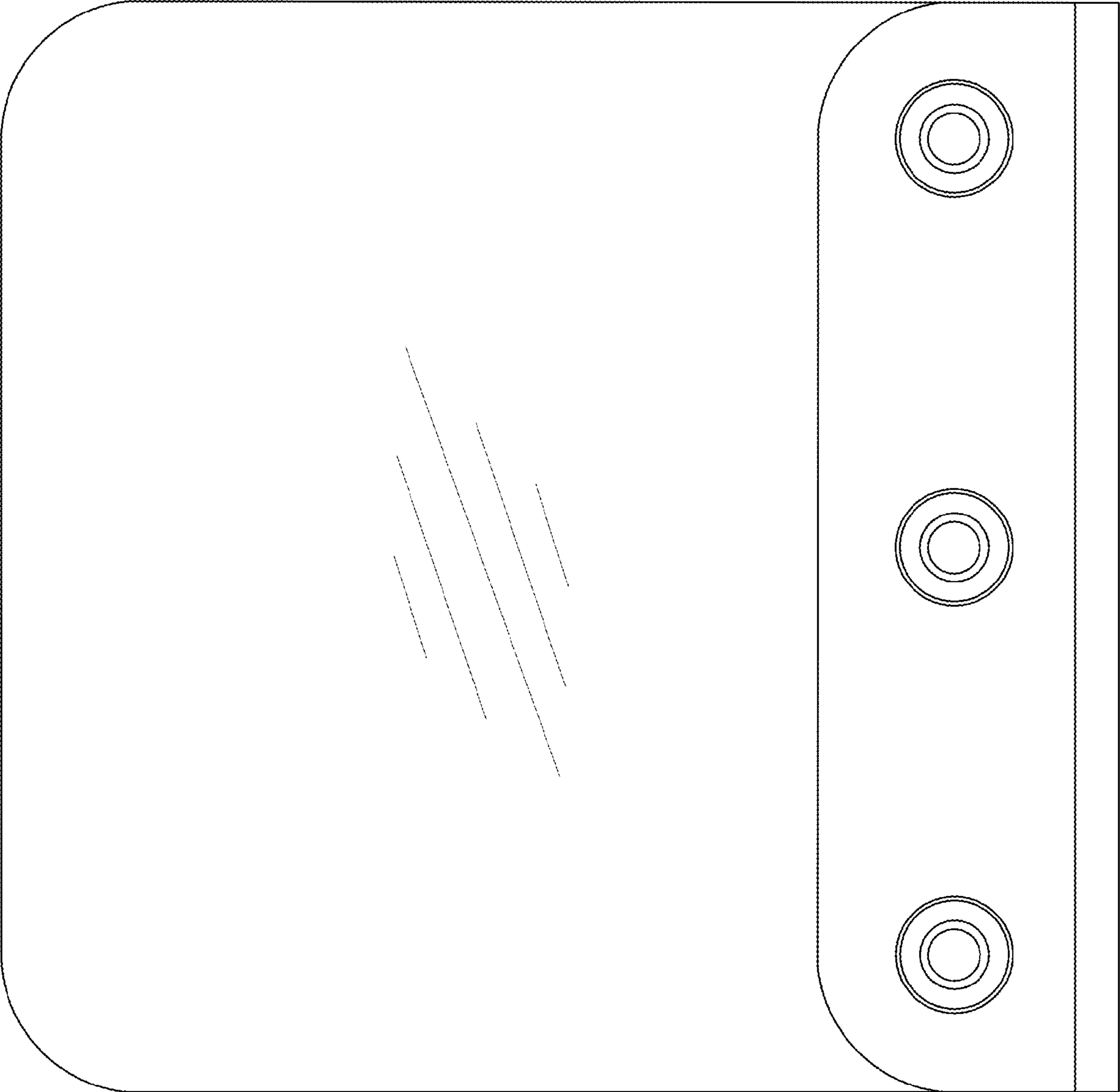

FIG. 3

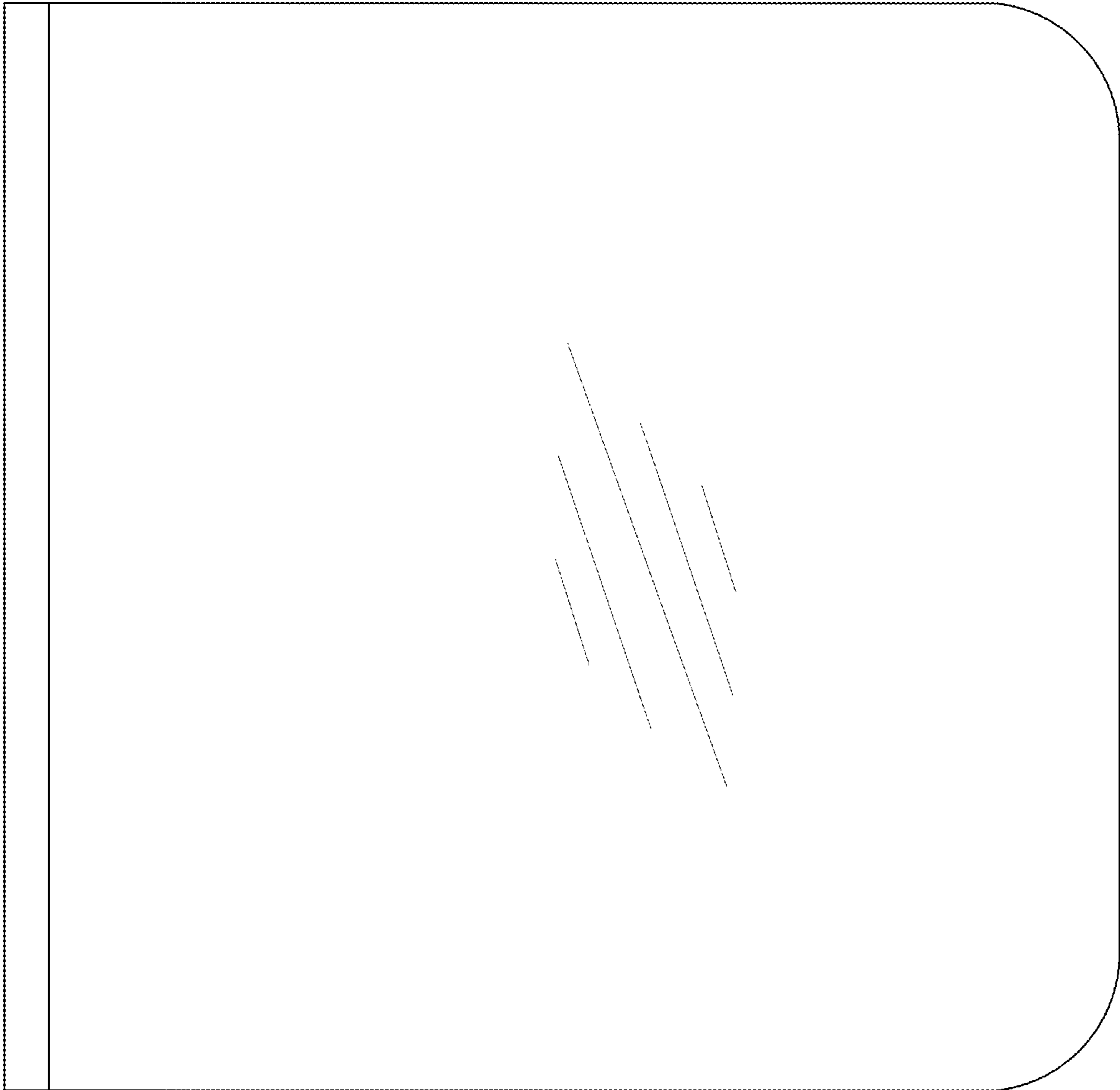

FIG. 4

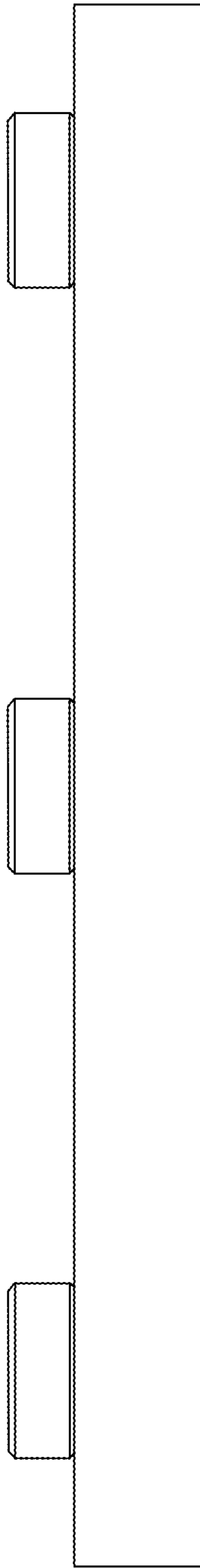

FIG. 5

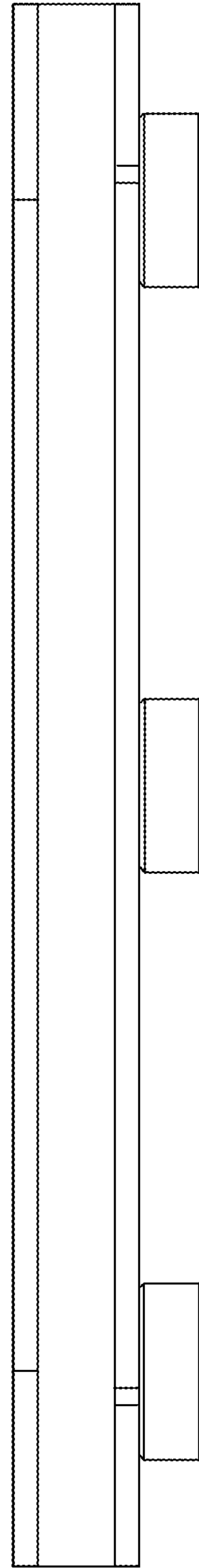

FIG. 6

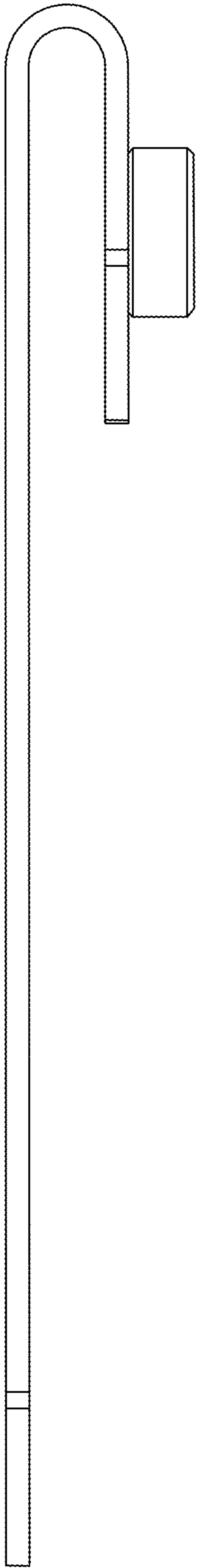

FIG. 7

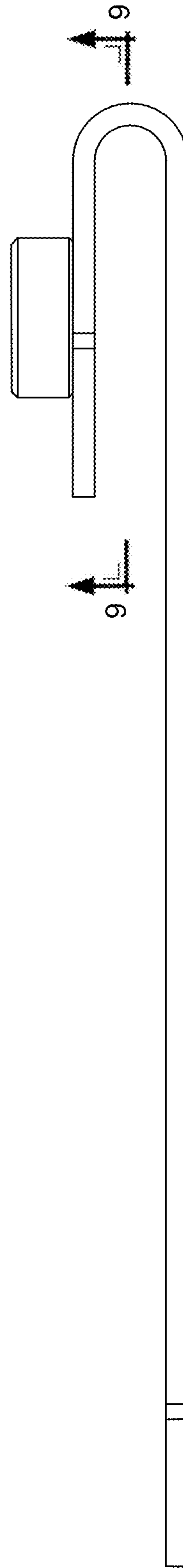

FIG. 8

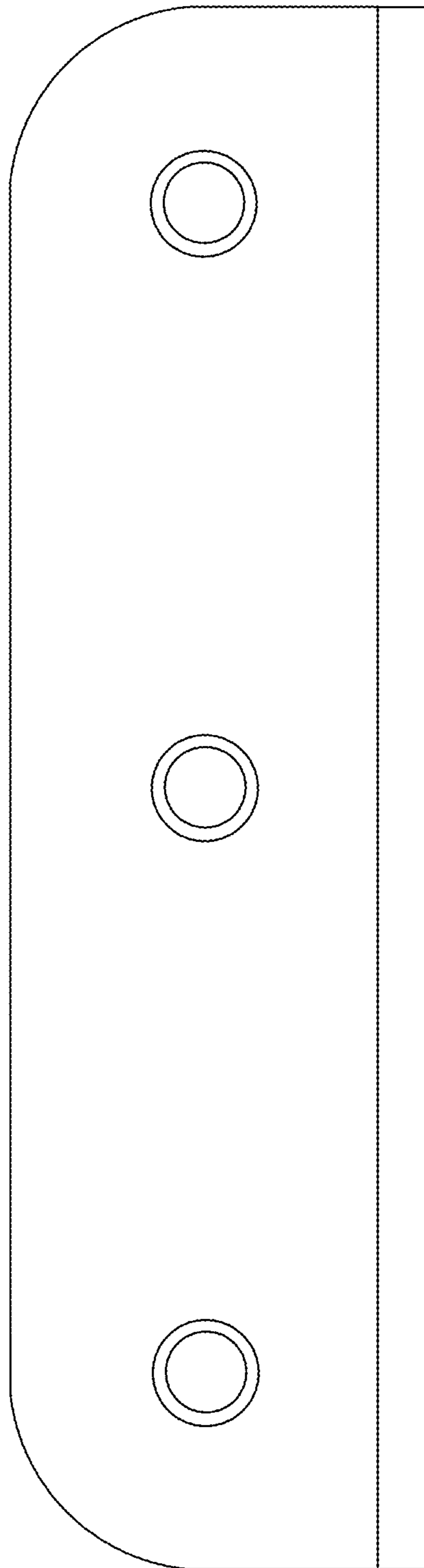

FIG. 9