



US00D927285S

(12) **United States Design Patent** (10) **Patent No.:** **US D927,285 S**  
**Singtoroj et al.** (45) **Date of Patent:** **\*\* Aug. 10, 2021**

(54) **DEADBOLT FACEPLATE WITH LED STRIP HAVING ANIMATED ILLUMINATION**

(71) Applicant: **Spectrum Brands, Inc.**, Middleton, WI (US)

(72) Inventors: **Yos Singtoroj**, Anaheim, CA (US); **Wei Hsu**, Lake Forest, CA (US); **Elliott Schneider**, Foothill Ranch, CA (US)

(73) Assignee: **Spectrum Brands, Inc.**, Middleton, WI (US)

(\*\*) Term: **15 Years**

(21) Appl. No.: **29/612,603**

(22) Filed: **Aug. 2, 2017**

(51) **LOC (13) Cl.** ..... **08-07**

(52) **U.S. Cl.**  
USPC ..... **D8/343**; D14/485

(58) **Field of Classification Search**  
USPC ..... D8/331, 332, 343; D10/106.95, 111, D10/114.1; D14/488-495  
CPC ..... G07C 9/00174; G06F 3/048-04897  
See application file for complete search history.

(56) **References Cited**

U.S. PATENT DOCUMENTS

2,914,656	A	11/1959	Keith	
3,719,821	A	3/1973	Foreman	
4,126,341	A	11/1978	Bradstock	
4,196,422	A	4/1980	Swigert et al.	
4,559,796	A	12/1985	De Forrest, Sr.	
4,683,741	A	8/1987	Fields	
4,760,380	A	7/1988	Quenneville et al.	
4,777,570	A	10/1988	Littles	
5,057,975	A	10/1991	Evigan	
5,111,007	A	5/1992	Miller et al.	
D349,037	S	7/1994	Carsello	
D365,976	S	1/1996	Chiu	
5,611,613	A	3/1997	Bergen et al.	
D396,798	S	8/1998	Adelmeyer et al.	
5,996,383	A	12/1999	Adelmeyer et al.	
6,016,677	A	1/2000	Clark	
D428,821	S *	8/2000	Matsuda	D10/111

6,225,903	B1	5/2001	Soloway et al.	
6,305,814	B1	10/2001	Giamas	
D462,005	S	8/2002	Nakamaru	
6,622,537	B2	9/2003	Rodriguez	
D488,702	S	4/2004	Hansen	
D494,841	S	8/2004	Moon et al.	
D513,469	S	1/2006	Gao et al.	
D518,353	S	4/2006	Van Handel	
D524,322	S *	7/2006	Braff	D14/488
D526,327	S *	8/2006	Braff	D14/488
7,091,429	B2	8/2006	Case et al.	
7,108,387	B1	9/2006	Lucas	
D530,185	S	10/2006	Osiecki et al.	
D533,047	S	12/2006	Wright et al.	
D533,871	S *	12/2006	Stabb	D14/485
7,172,306	B1	2/2007	Campa	
7,210,421	B1	5/2007	Pendergraph	
7,248,163	B2	7/2007	Wu	
D550,233	S *	9/2007	Vigesaa	D14/487
D552,964	S	10/2007	Bogdanov et al.	
D552,968	S	10/2007	Roberts et al.	
D553,953	S	10/2007	Roberts et al.	
D554,974	S	11/2007	Huang	
D558,220	S *	12/2007	Maitlen	D14/487
D576,864	S *	9/2008	Blomstrom	D8/343
D577,277	S	9/2008	Samhammer et al.	
D595,109	S	6/2009	Doucet et al.	
D608,235	S *	1/2010	Ishikawa	D10/114.1
D618,081	S	6/2010	Moyer	
7,832,887	B2	11/2010	Battle	
7,866,195	B2	1/2011	Levine	
D635,444	S	4/2011	Roberts, III	
D638,276	S	5/2011	Tonizzo et al.	
7,990,280	B2	8/2011	Gray	
8,037,725	B2	10/2011	Levine	
D649,012	S	11/2011	Gartner	
8,138,917	B2	3/2012	Diener et al.	
8,141,400	B2	3/2012	Sorensen et al.	
8,284,018	B2	10/2012	Ibsies	
8,331,544	B2	12/2012	Kraus et al.	
D680,416	S	4/2013	Dalton	
D682,656	S	5/2013	Cramer et al.	
D682,657	S	5/2013	Roberts, III	
D682,658	S	5/2013	Cramer et al.	
D684,842	S	6/2013	Chan et al.	
D701,748	S	4/2014	Weathersby et al.	
D722,260	S	2/2015	Warmenhoven et al.	
D722,633	S	2/2015	Au	
D732,923	S	6/2015	Rechberg et al.	
D733,522	S	7/2015	Kim et al.	
9,085,919	B2	7/2015	Bacon	
D736,591	S	8/2015	Groleski et al.	
D736,596	S	8/2015	Warmenhoven et al.	

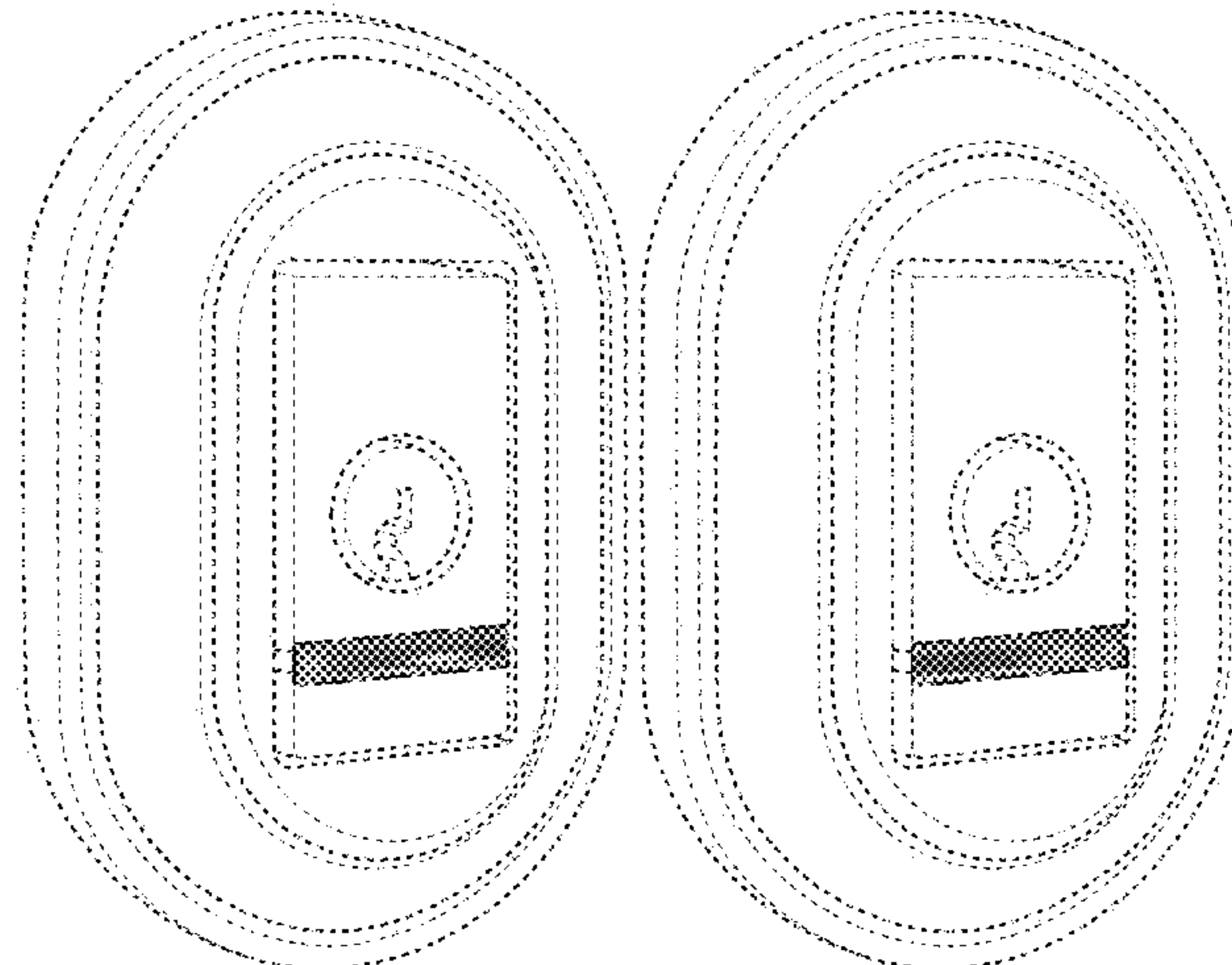

D737,118	S	8/2015	Chan et al.	
D737,661	S	9/2015	Chan	
D739,417	S *	9/2015	Laverack .....	D14/485
D743,432	S *	11/2015	Sergeev .....	D14/487
D745,018	S *	12/2015	Balles .....	D14/485
D755,037	S	5/2016	Czerwinski, Jr. et al.	
D758,418	S *	6/2016	Sawai .....	D14/488
D761,275	S *	7/2016	Kim .....	D14/485
9,424,235	B2 *	8/2016	Chamberlain .....	G06F 40/177
D767,582	S *	9/2016	Kim .....	D14/485
9,441,403	B2	9/2016	Kraus et al.	
9,443,364	B2	9/2016	Snider	
D773,526	S *	12/2016	Butcher .....	D14/488
9,617,757	B2	4/2017	Lowder	
D790,950	S	7/2017	Kraus et al.	
D792,453	S *	7/2017	Butcher .....	D14/488
D793,437	S *	8/2017	Orr .....	D14/490
D795,041	S	8/2017	Oliva Camacho et al.	
D807,388	S *	1/2018	Butcher .....	G06F 40/177 D14/486
D811,851	S *	3/2018	Hsu et al. ....	D14/485
D846,566	S *	4/2019	Kim .....	D14/485
D847,150	S *	4/2019	Joo .....	D14/485
D848,455	S *	5/2019	Robert .....	D14/485
D849,759	S *	5/2019	Tegethoff .....	D14/485
D849,760	S *	5/2019	Tegethoff .....	D14/485
D853,875	S *	7/2019	Stein .....	D10/114.1
D859,430	S *	9/2019	Naimark .....	D14/485
D864,007	S *	10/2019	Stokes .....	D10/114.1
D870,749	S *	12/2019	Kim .....	D14/485
D884,902	S *	5/2020	Nishiyama .....	D24/165
D888,091	S *	6/2020	Becker .....	D14/488
D889,483	S *	7/2020	Amini .....	D14/485
D889,484	S *	7/2020	Amini .....	D14/485
D895,666	S *	9/2020	Felkins .....	D14/488
D895,667	S *	9/2020	Felkins .....	D14/488
2003/0063009	A1	4/2003	Pelletier et al.	
2004/0066647	A1	4/2004	Brady	
2005/0248931	A1	11/2005	Alvarez	
2006/0213243	A1	9/2006	Bosin	
2009/0180277	A1	7/2009	Falce	
2012/0073338	A1	3/2012	Mohla	
2012/0234058	A1	9/2012	Neil et al.	
2013/0237193	A1	9/2013	Dumas et al.	
2014/0033773	A1	2/2014	Myers et al.	
2014/0260449	A1	9/2014	Uyeda et al.	
2015/0126234	A1	5/2015	Rodriguez	
2018/0187452	A1 *	7/2018	Hsu et al. ....	G07C 9/00174

FOREIGN PATENT DOCUMENTS

EM	000599246-0001	4/2006
EM	001682691-0013	3/2010
EP	0611409 B1	5/1997
JP	2009-281287 A	12/2009
JP	2010-165313 A	7/2010
JP	201163991 A	3/2011
JP	20120073338 A	4/2012
JP	2016138415 A	8/2016
KR	100728581 B1	6/2007
TW	201606173 A	2/2016
WO	9953161 A1	10/1999
WO	18128926 A1	7/2018

OTHER PUBLICATIONS

Loading Bar, by Hierarch, Shutterstock.com, Updated Jul. 15, 2016, site visited Sep. 16, 2020, available online at <https://www.shutterstock.com/g/Hierarch/sets/47409789> (Year: 2016).\*

Kwikset 925 Kevo 2, build.com, site visited Sep. 16, 2020, available online at <https://www.build.com/kwikset-925-kevo-2-cnt/s1529475?uid=3588765#reviews> (Year: 2020).\*

Nov. 17, 2020—(KR) Second Office Action—App. No. 10-2019-7022637.

\* cited by examiner

*Primary Examiner* — Karen E Kearney

*Assistant Examiner* — Ian F Whitmore

(74) *Attorney, Agent, or Firm* — Banner & Witcoff, Ltd.

(57)

**CLAIM**

The ornamental design for a deadbolt faceplate with LED strip having animated illumination, as shown and described.

**DESCRIPTION**

The patent or application file contains at least one drawing executed in color. Copies of this patent or patent application with color drawing(s) will be provided by the Office upon request and payment of the necessary fee.

FIG. 1 is the first image in the sequence for a deadbolt faceplate with LED strip having animated illumination showing our new design; FIG. 2 is the second image thereof; FIG. 3 is the third image thereof; FIG. 4 is the fourth image thereof; FIG. 5 is the fifth image thereof; FIG. 6 is the sixth image thereof; FIG. 7 is the seventh image thereof; FIG. 8 is the eighth image thereof; FIG. 9 is the ninth image thereof; FIG. 10 is the tenth image thereof; FIG. 11 is the eleventh image thereof; FIG. 12 is the twelfth image thereof; FIG. 13 is the thirteenth image thereof; FIG. 14 is the fourteenth image thereof; FIG. 15 is the fifteenth image thereof; FIG. 16 is the sixteenth image thereof; FIG. 17 is the seventeenth image thereof; FIG. 18 is the eighteenth image thereof; FIG. 19 is the nineteenth image thereof; and, FIG. 20 is the twentieth image thereof.

The appearance of the deadbolt faceplate with LED strip having animated illumination sequentially transitions between the images shown in FIGS. 1-20. The process or period in which one image transitions to another forms no part of the claimed design. The uneven-length broken lines represent boundary lines that form no part of the claimed design. The even-length broken lines, showing the remainder of the deadbolt faceplate, form no part of the claimed design.

**1 Claim, 7 Drawing Sheets**  
**(7 of 7 Drawing Sheet(s) Filed in Color)**



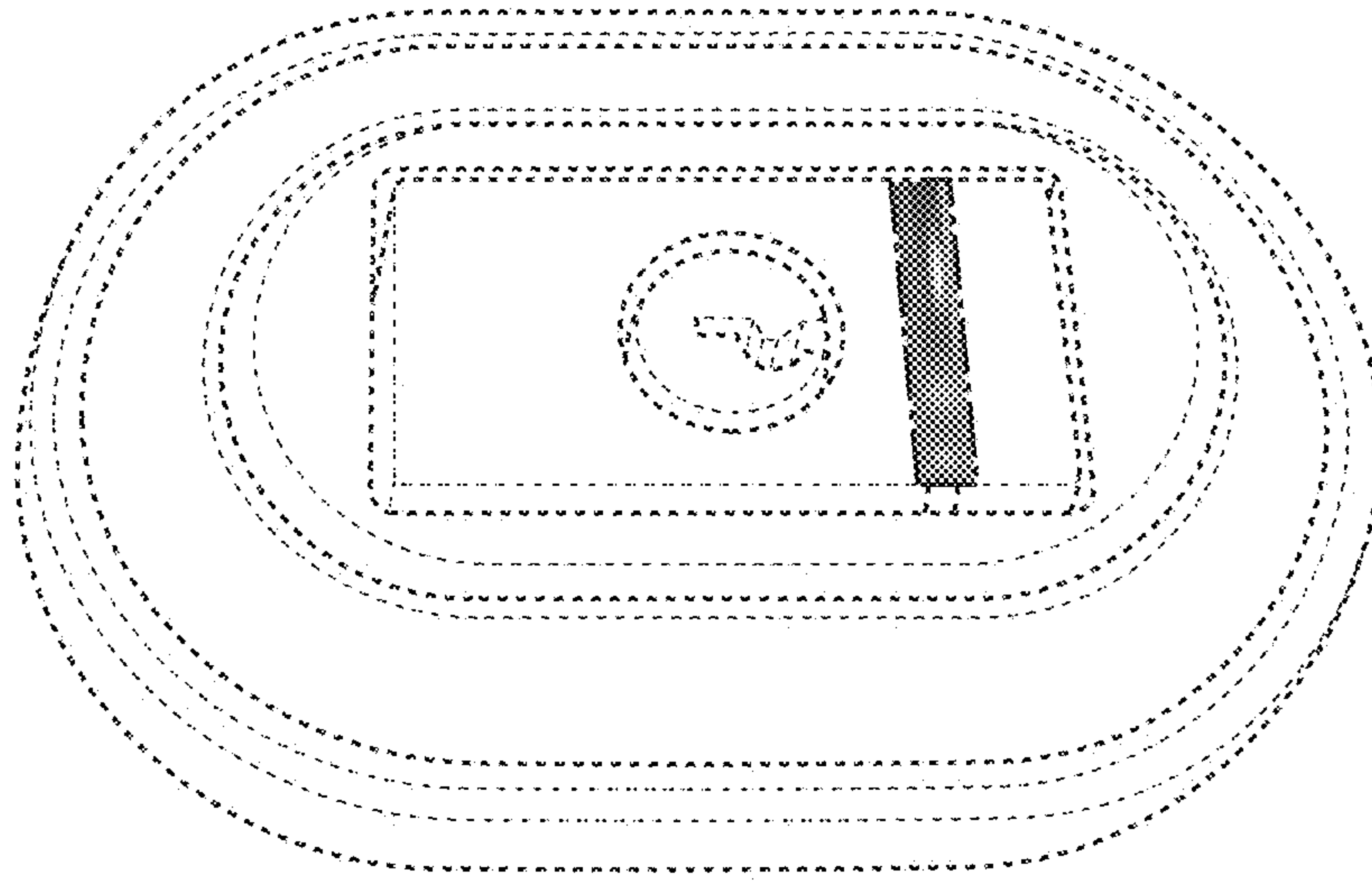

FIG. 3

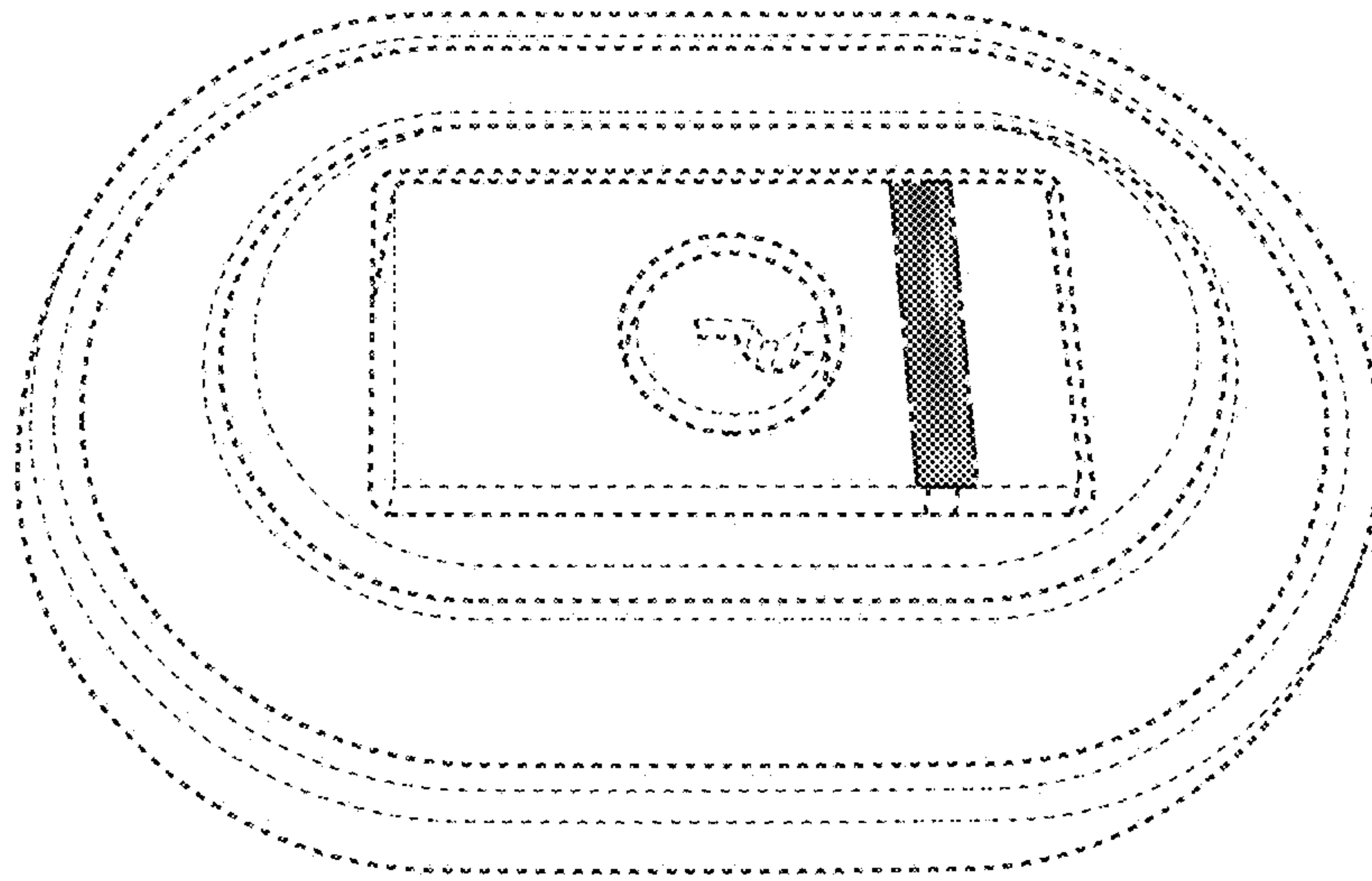

FIG. 2

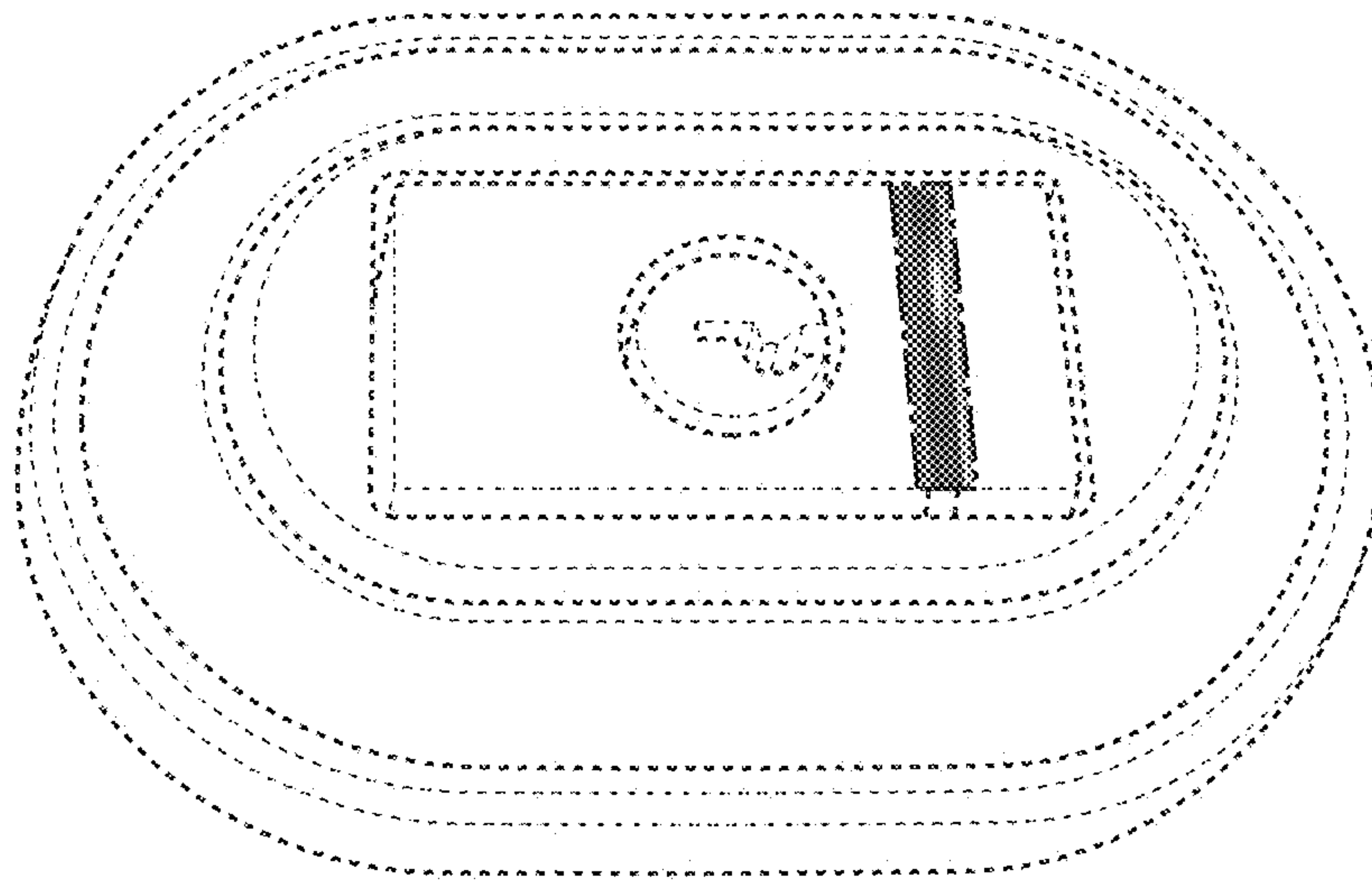

FIG. 1

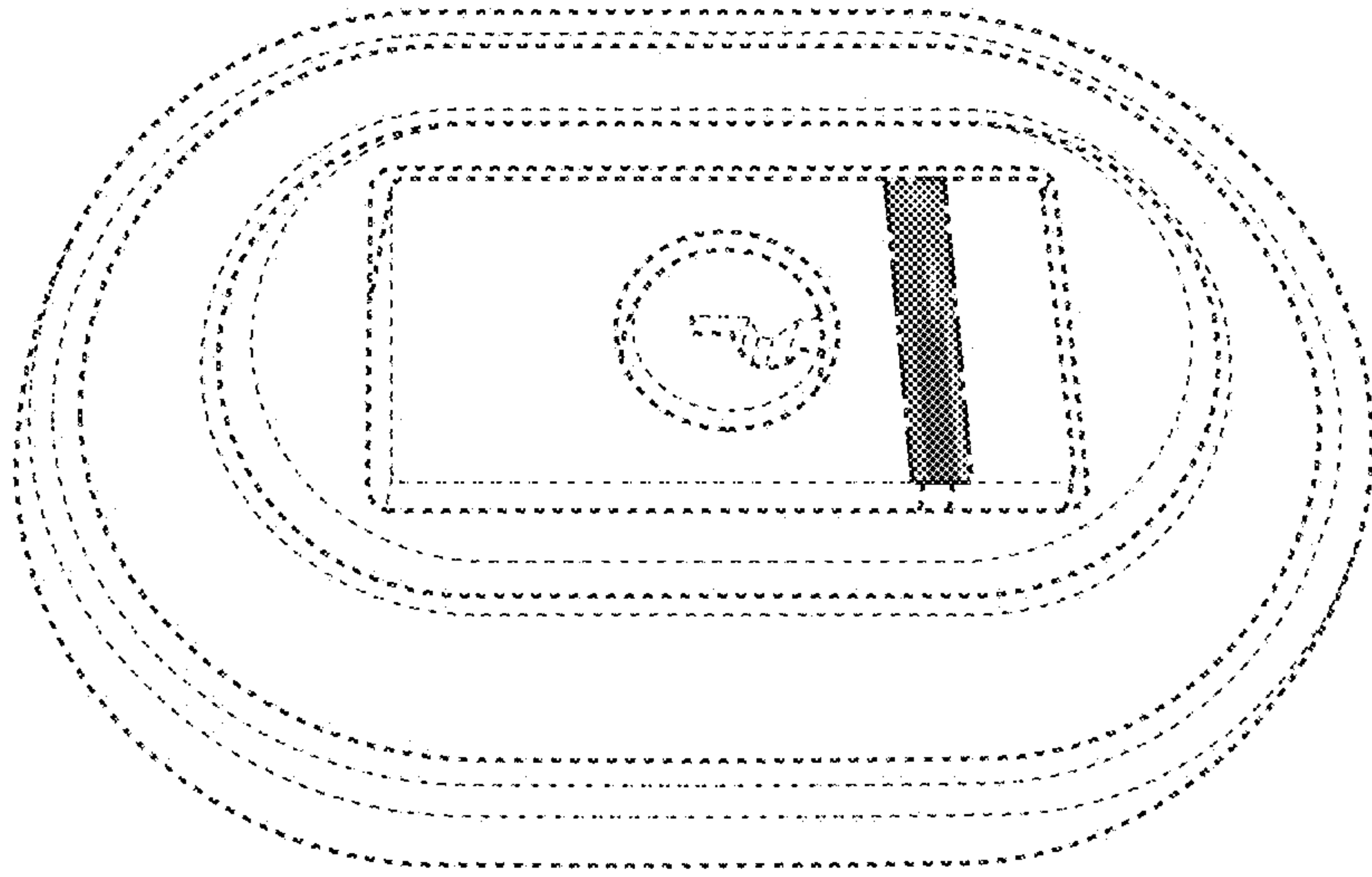

FIG. 4

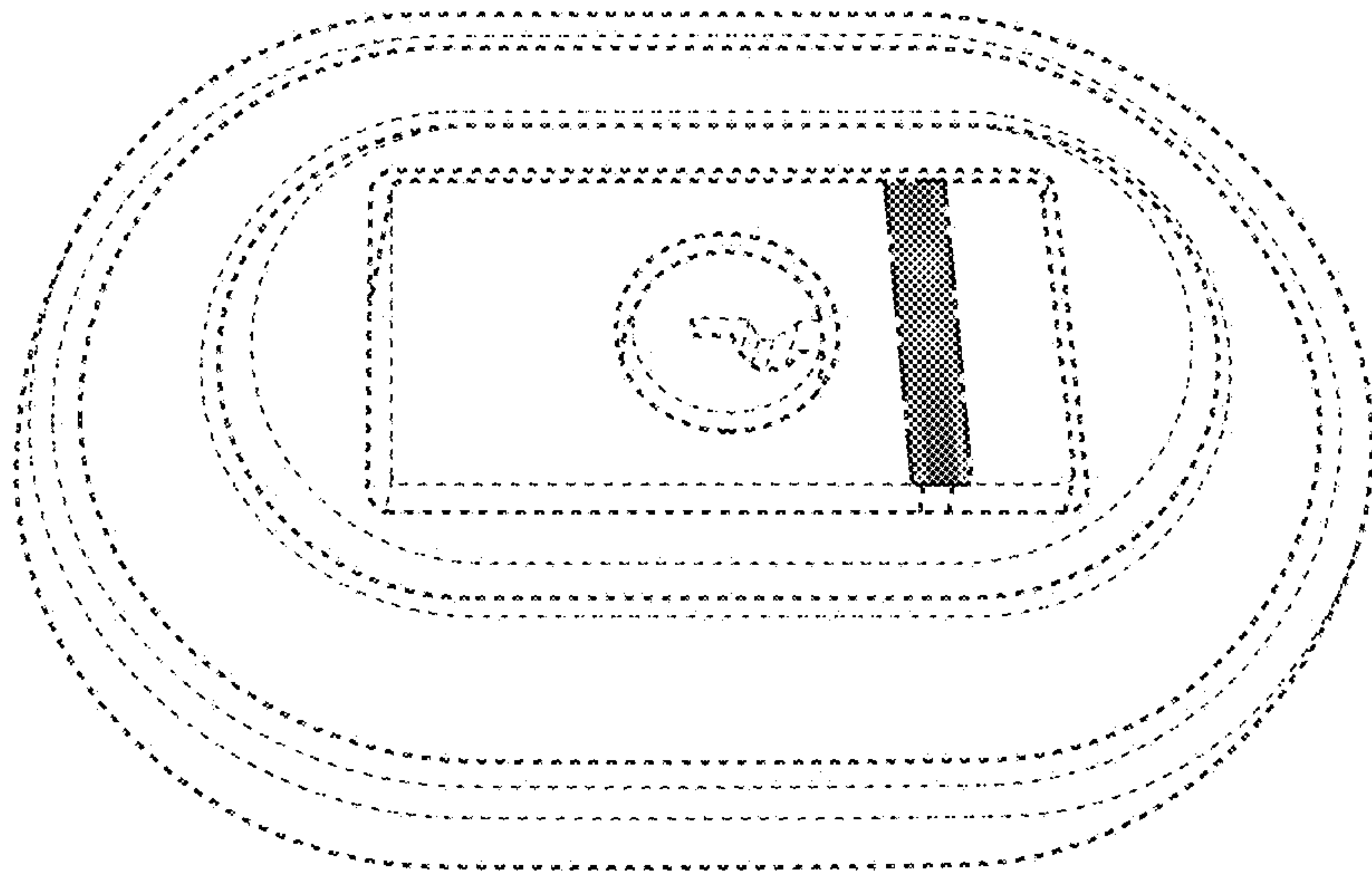

FIG. 5

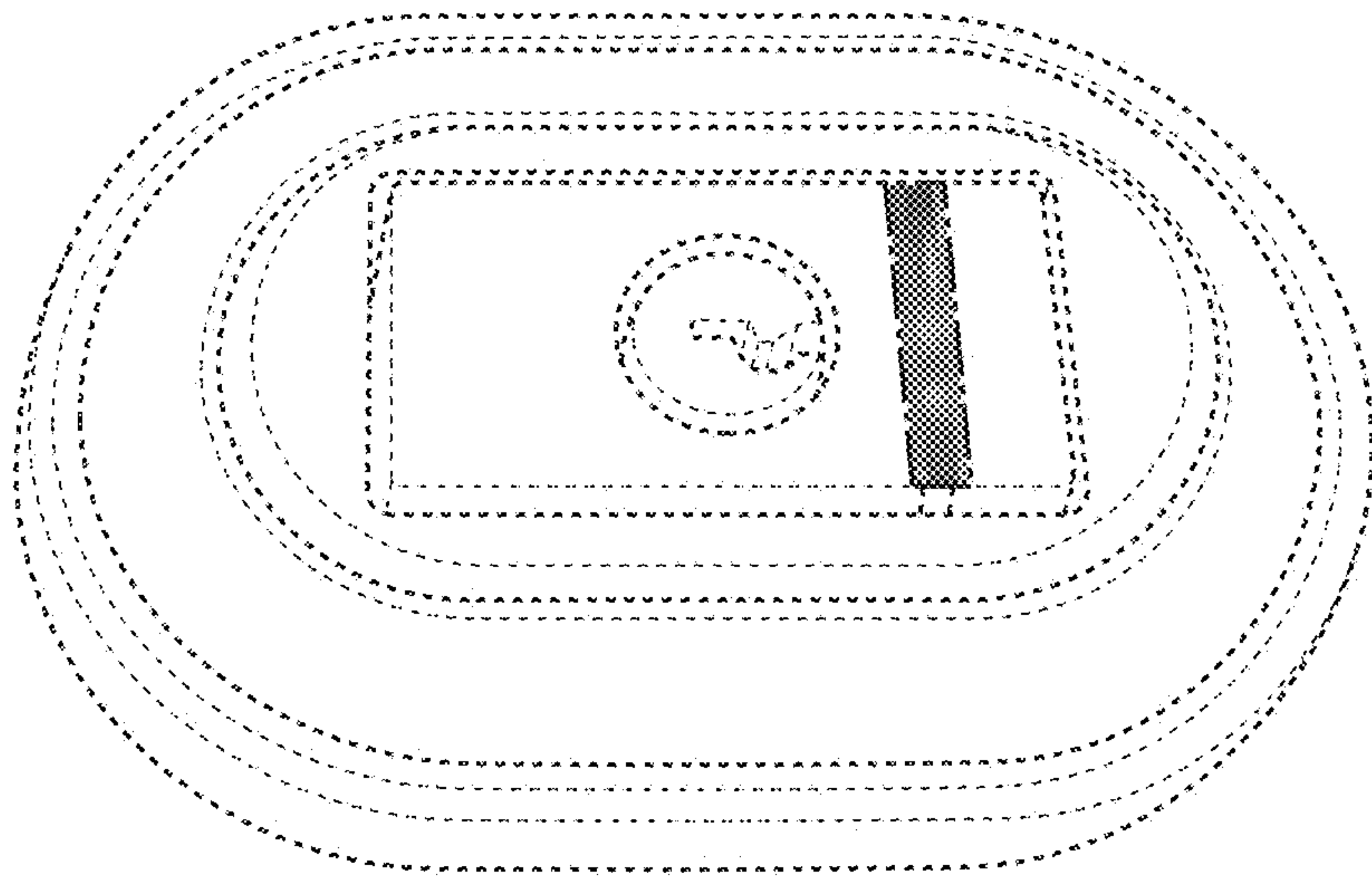

FIG. 6

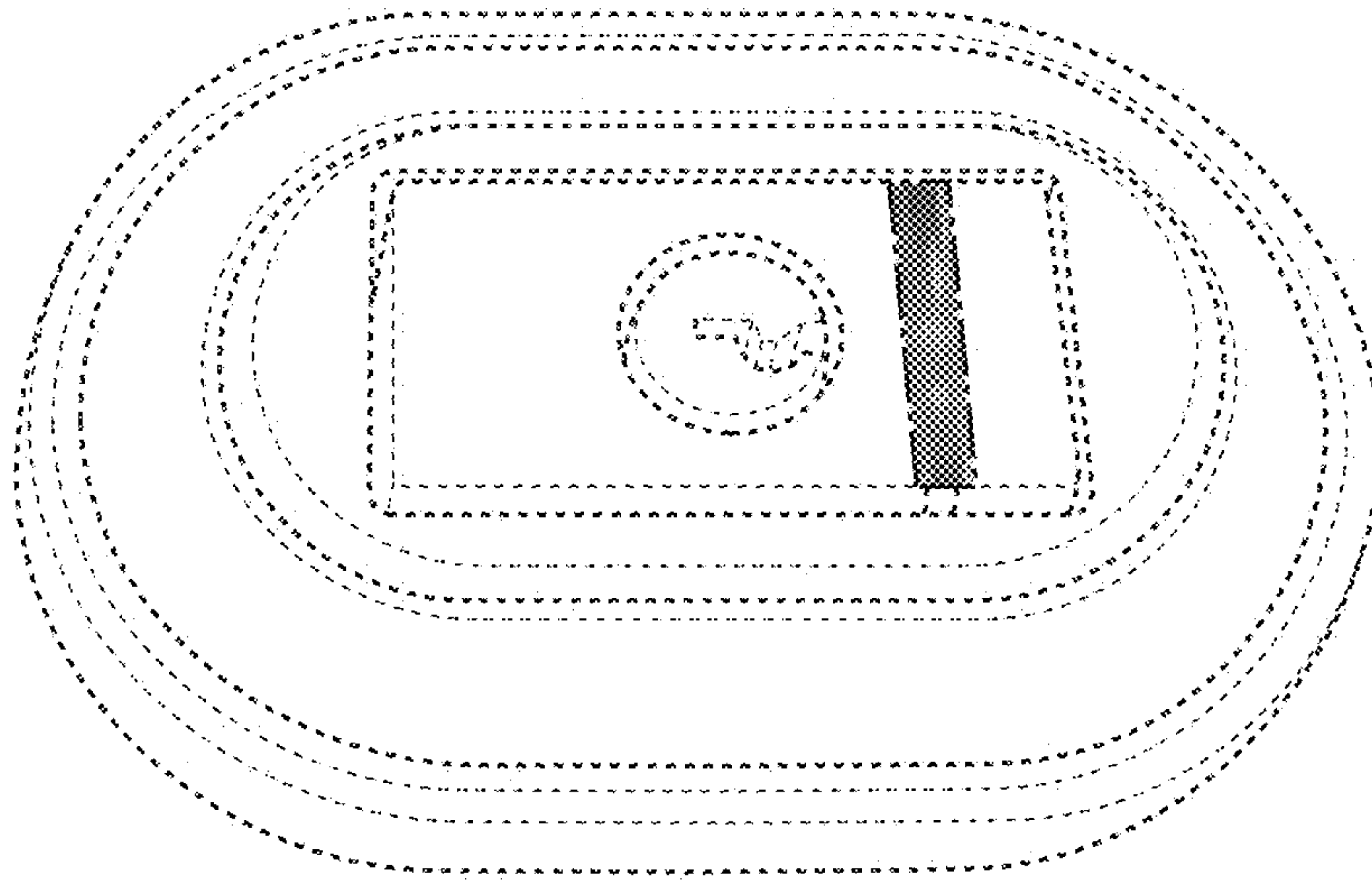

FIG. 9

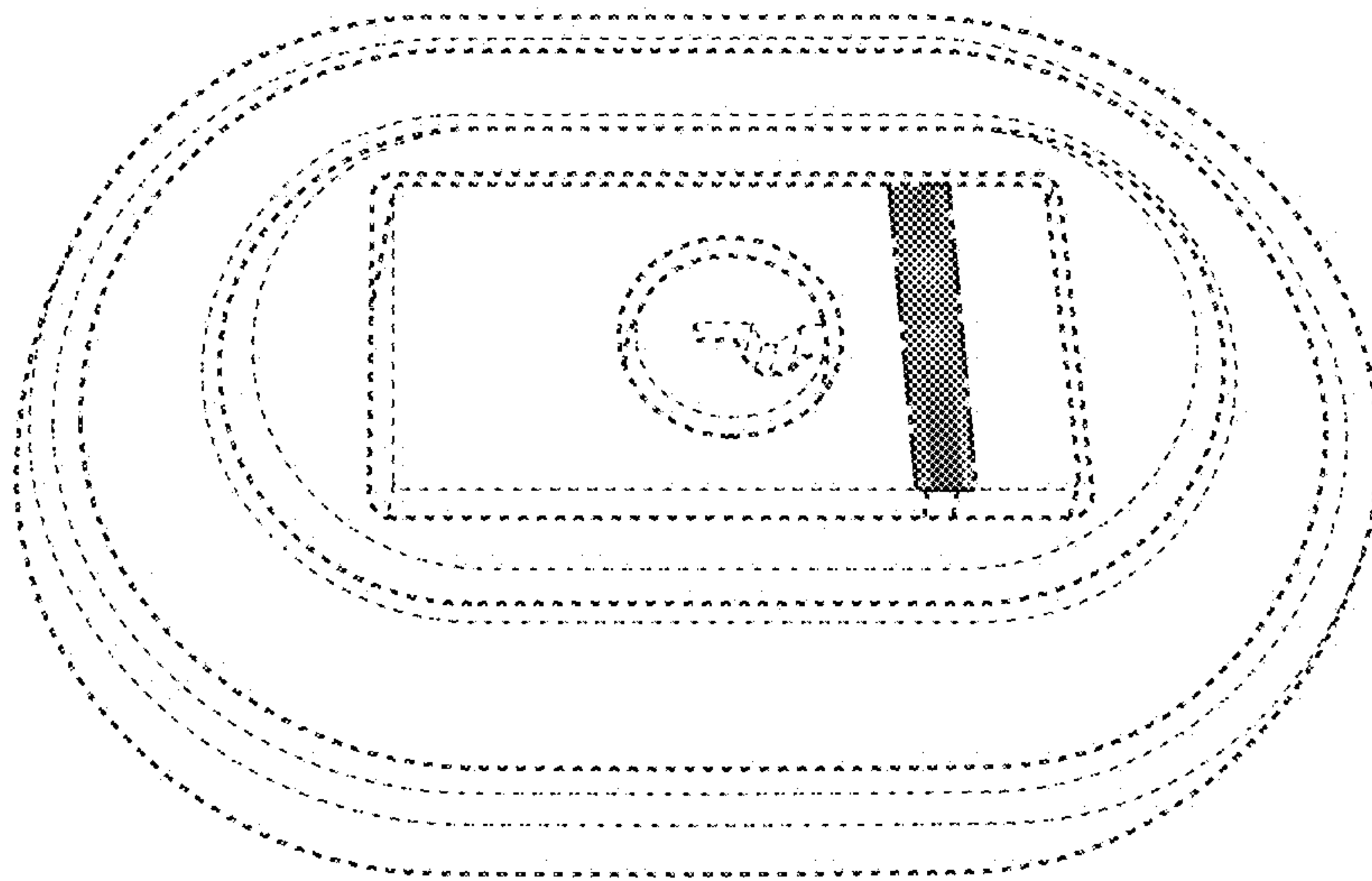

FIG. 8

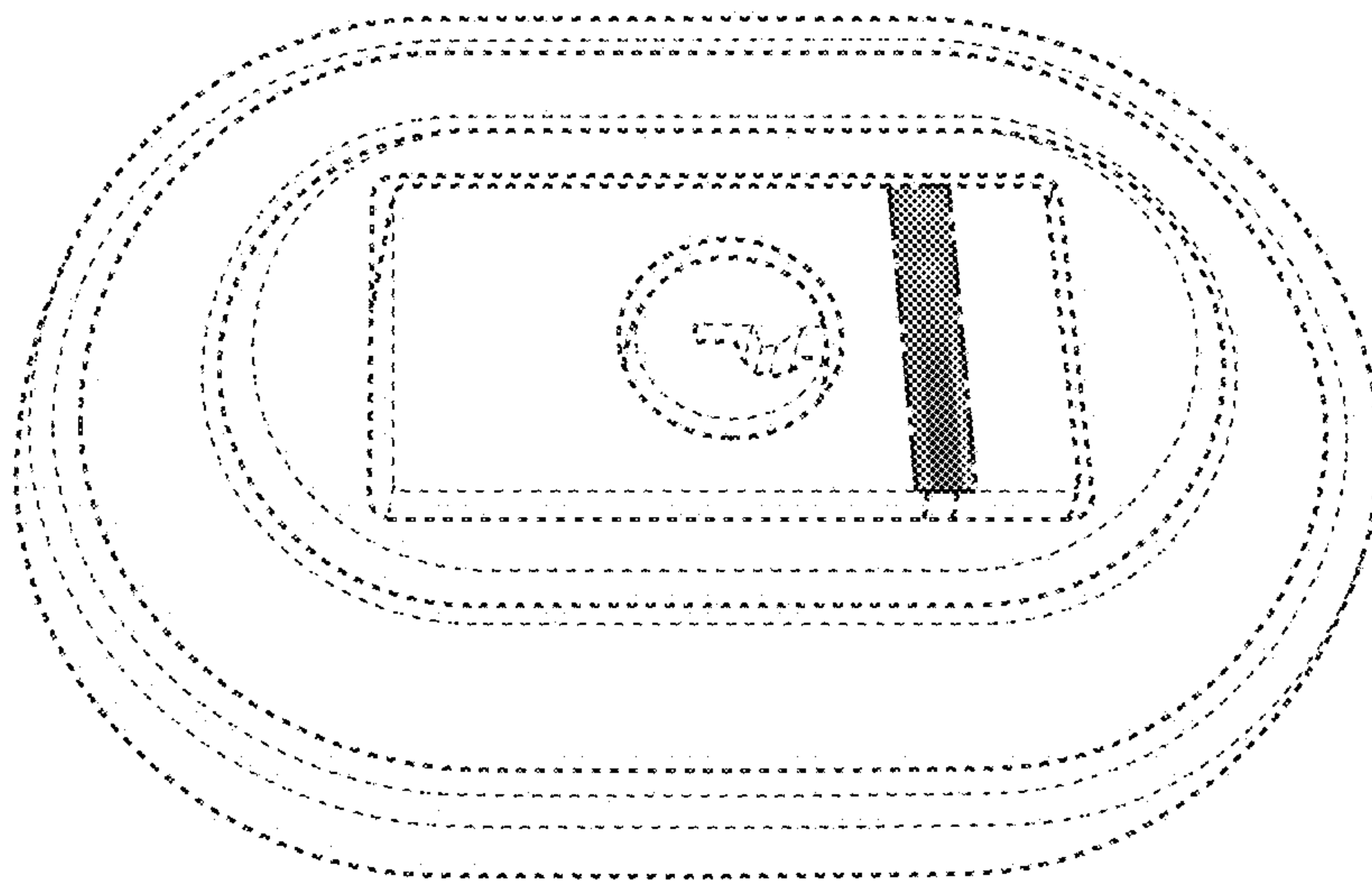

FIG. 7



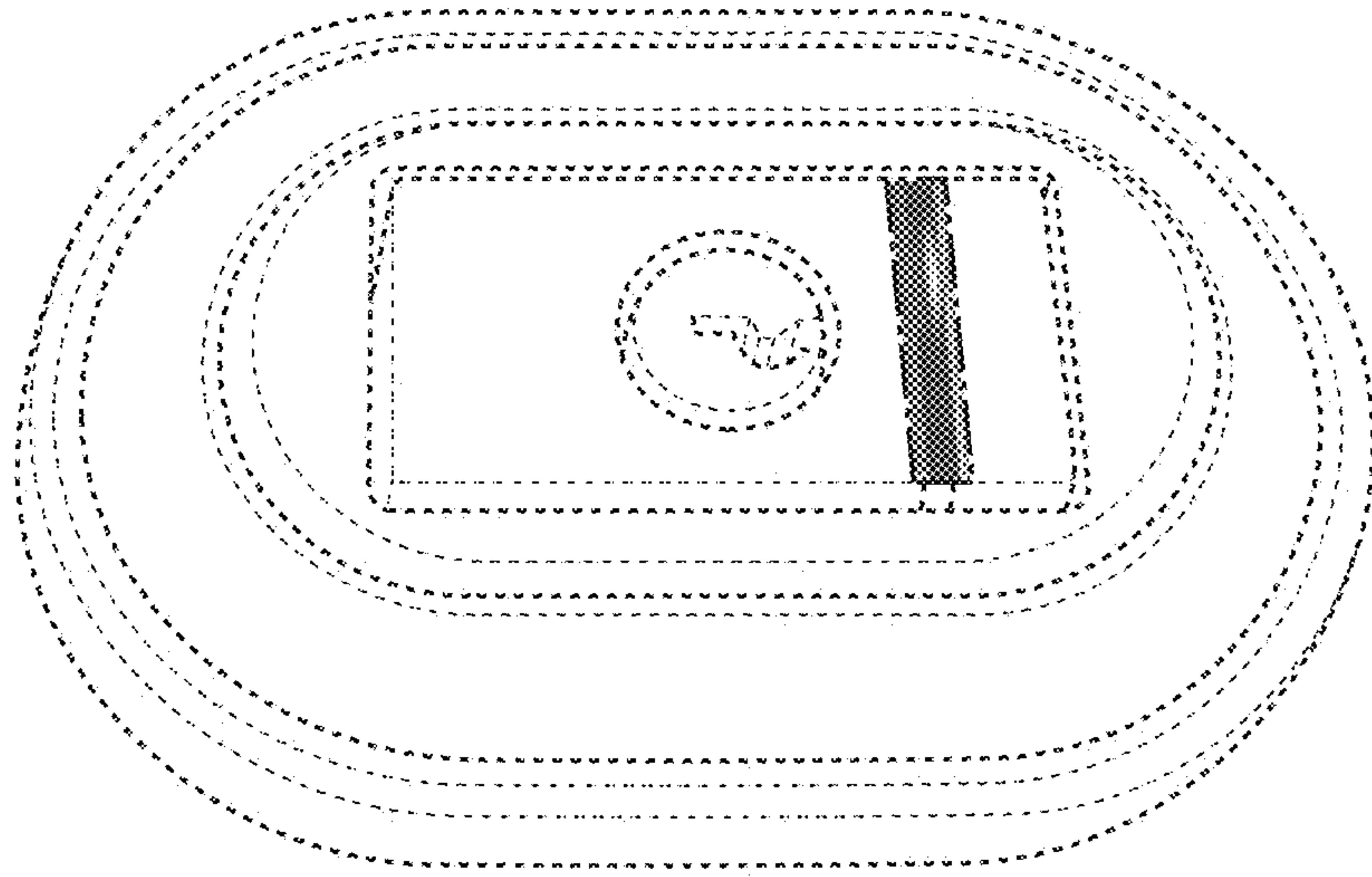

FIG. 10

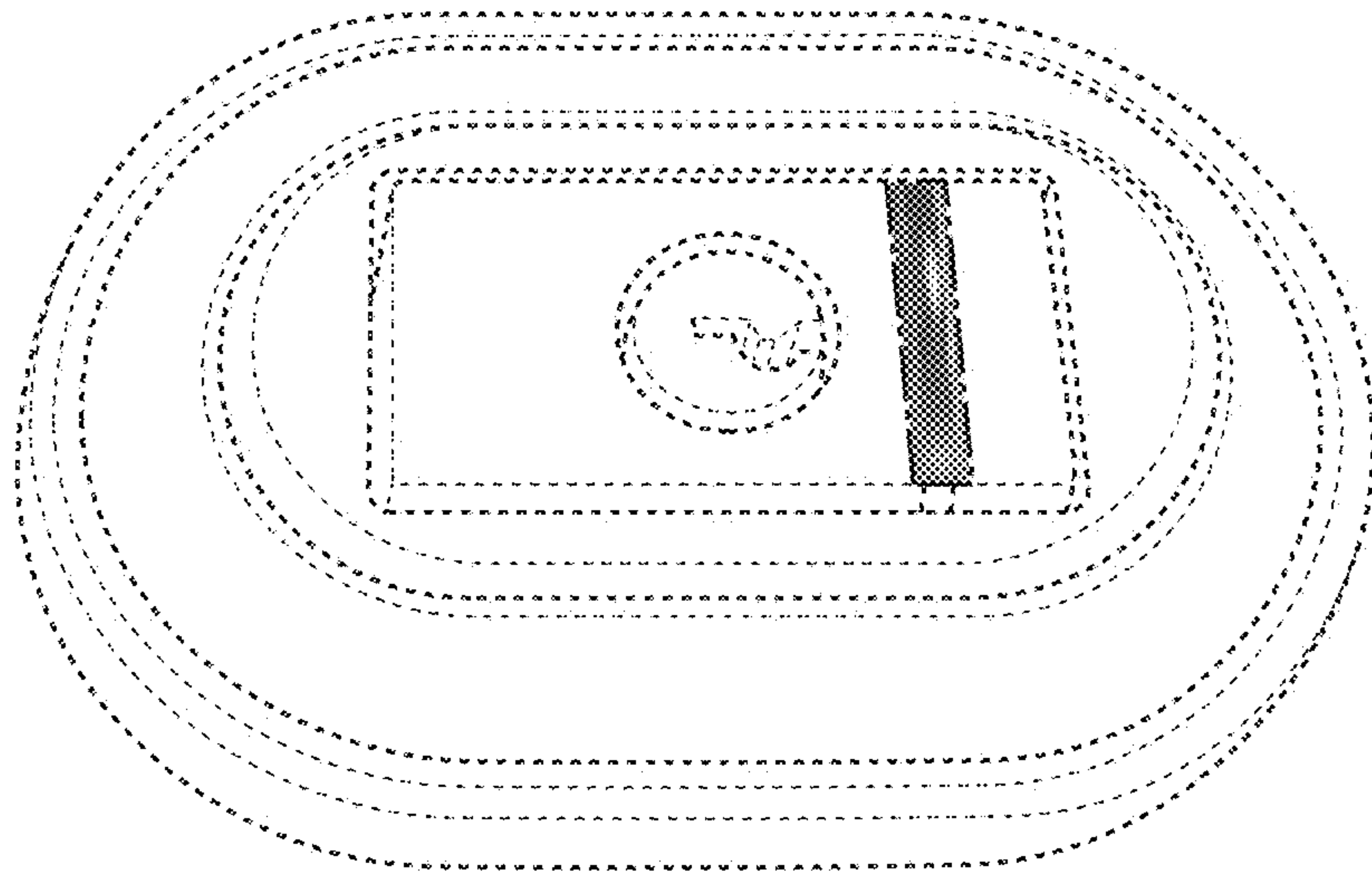

FIG. 11

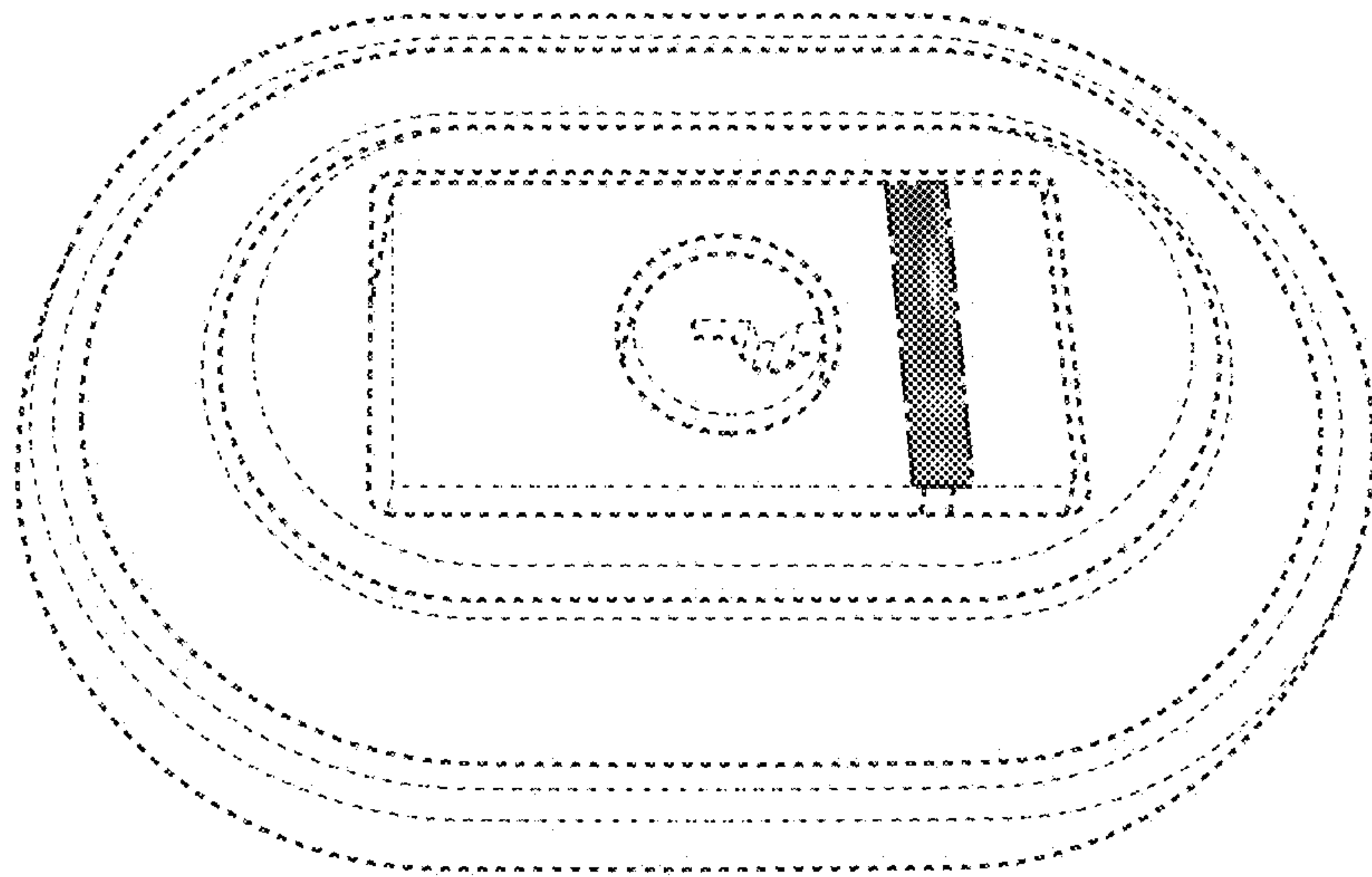

FIG. 12

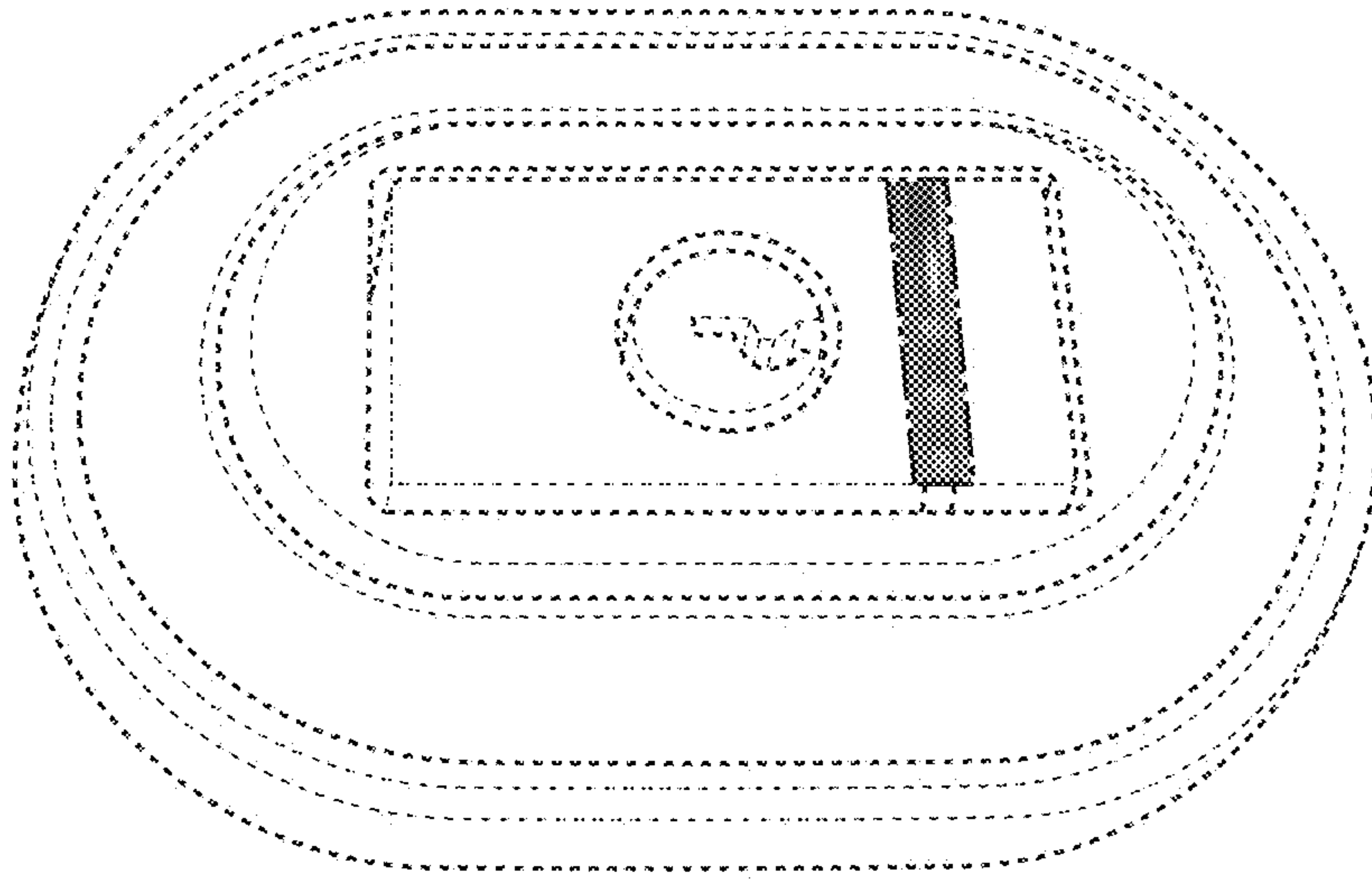

FIG. 13

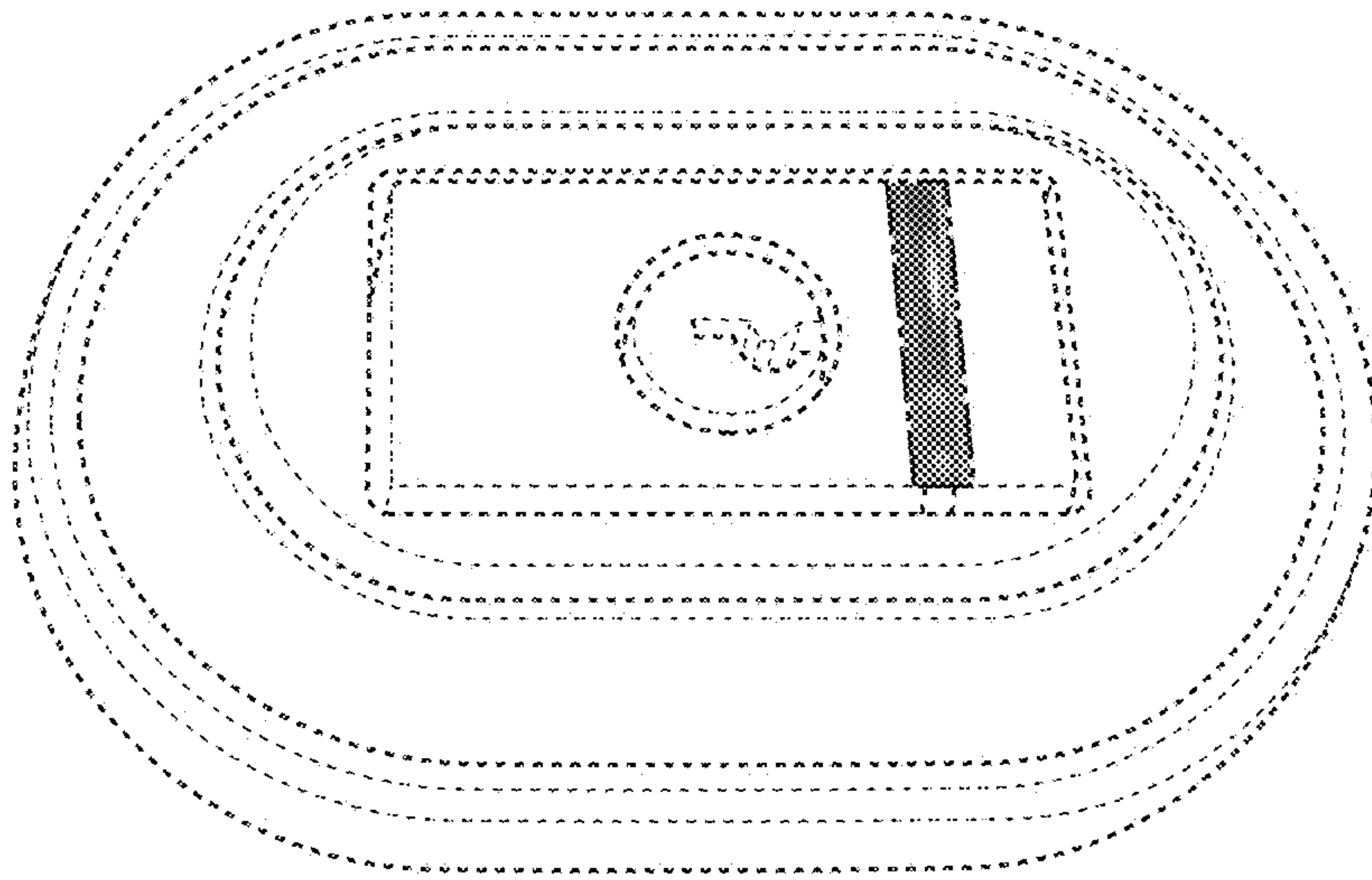

FIG. 14

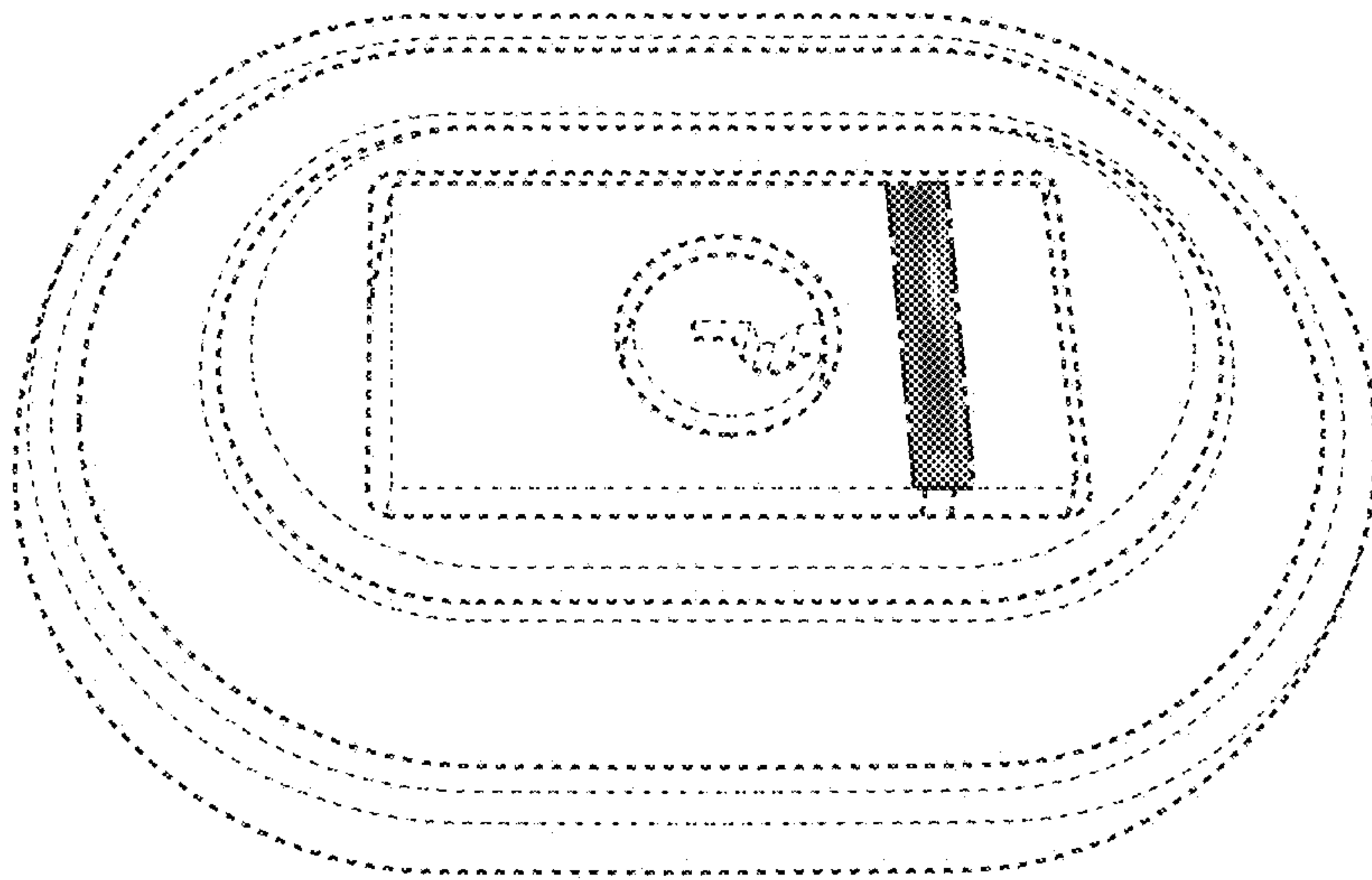

FIG. 15

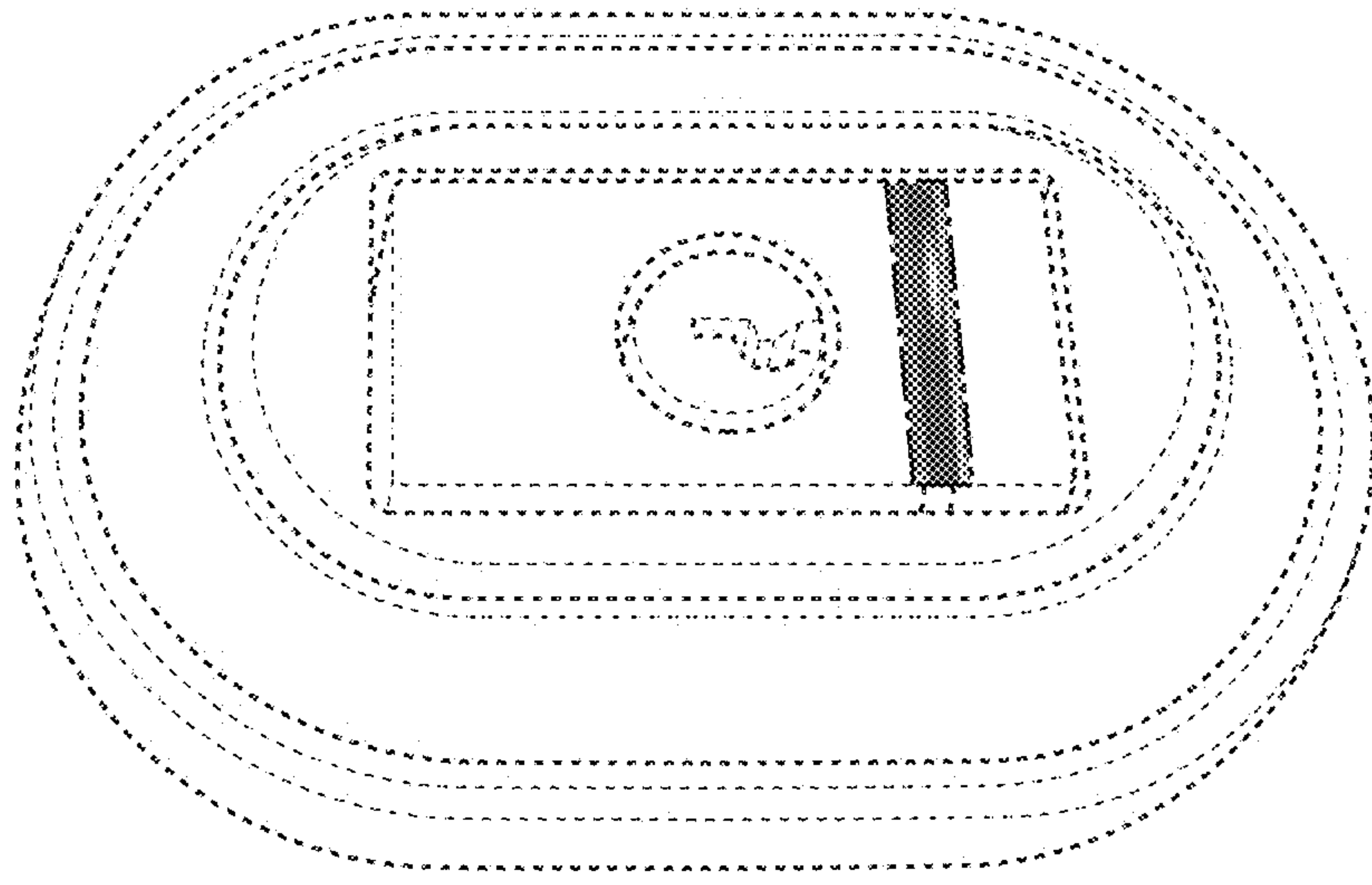

FIG. 18

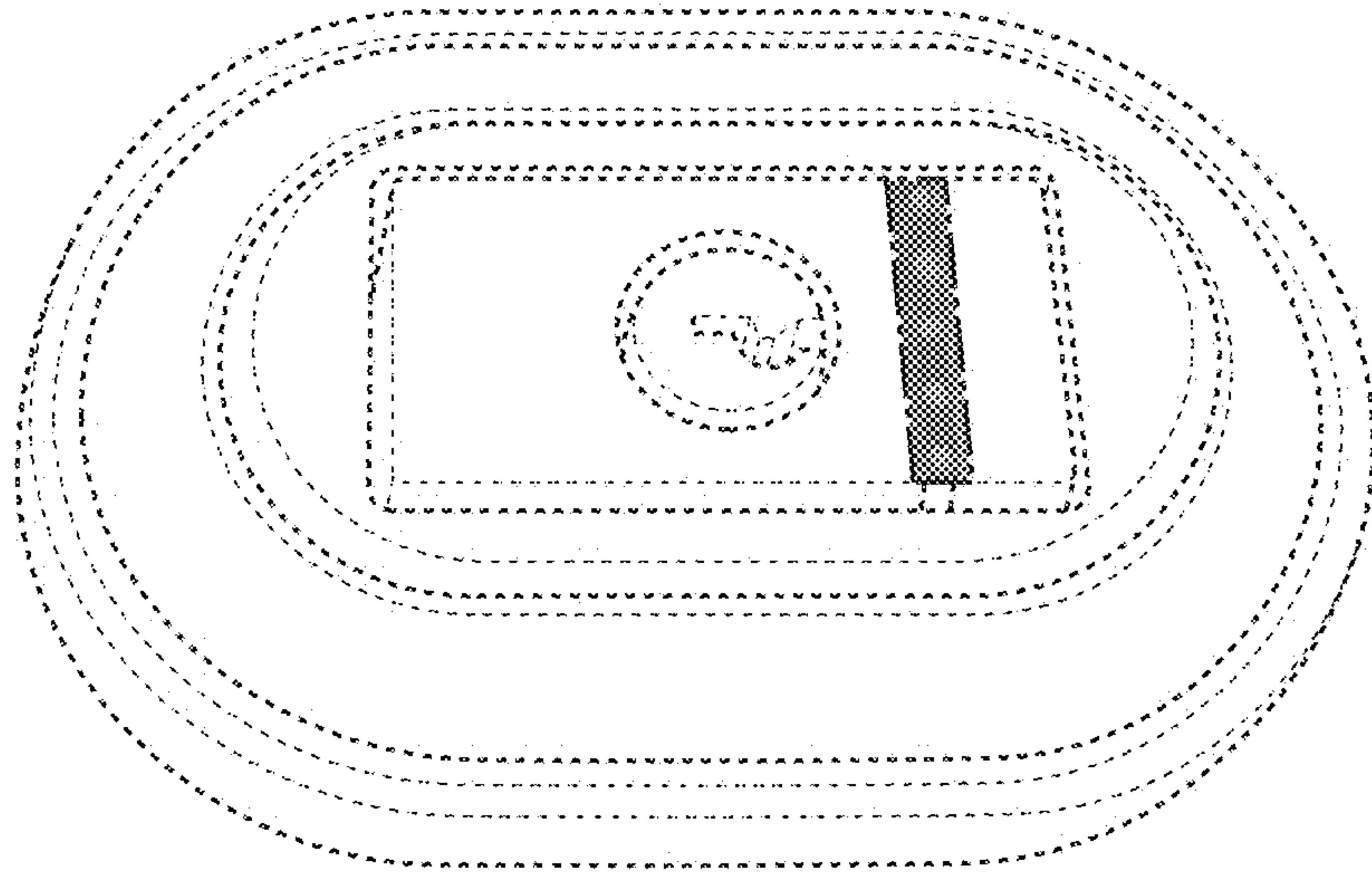

FIG. 17

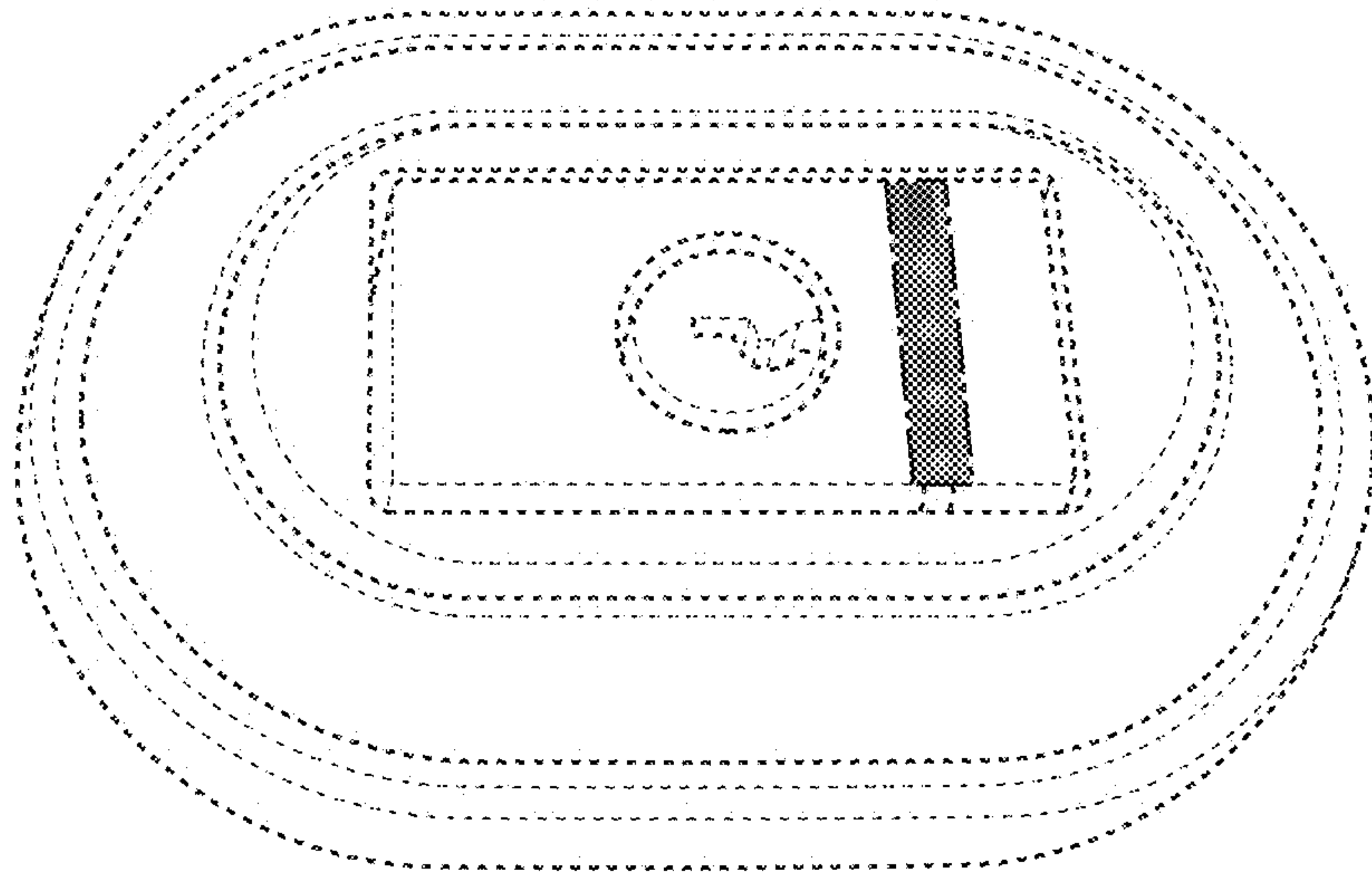

FIG. 16



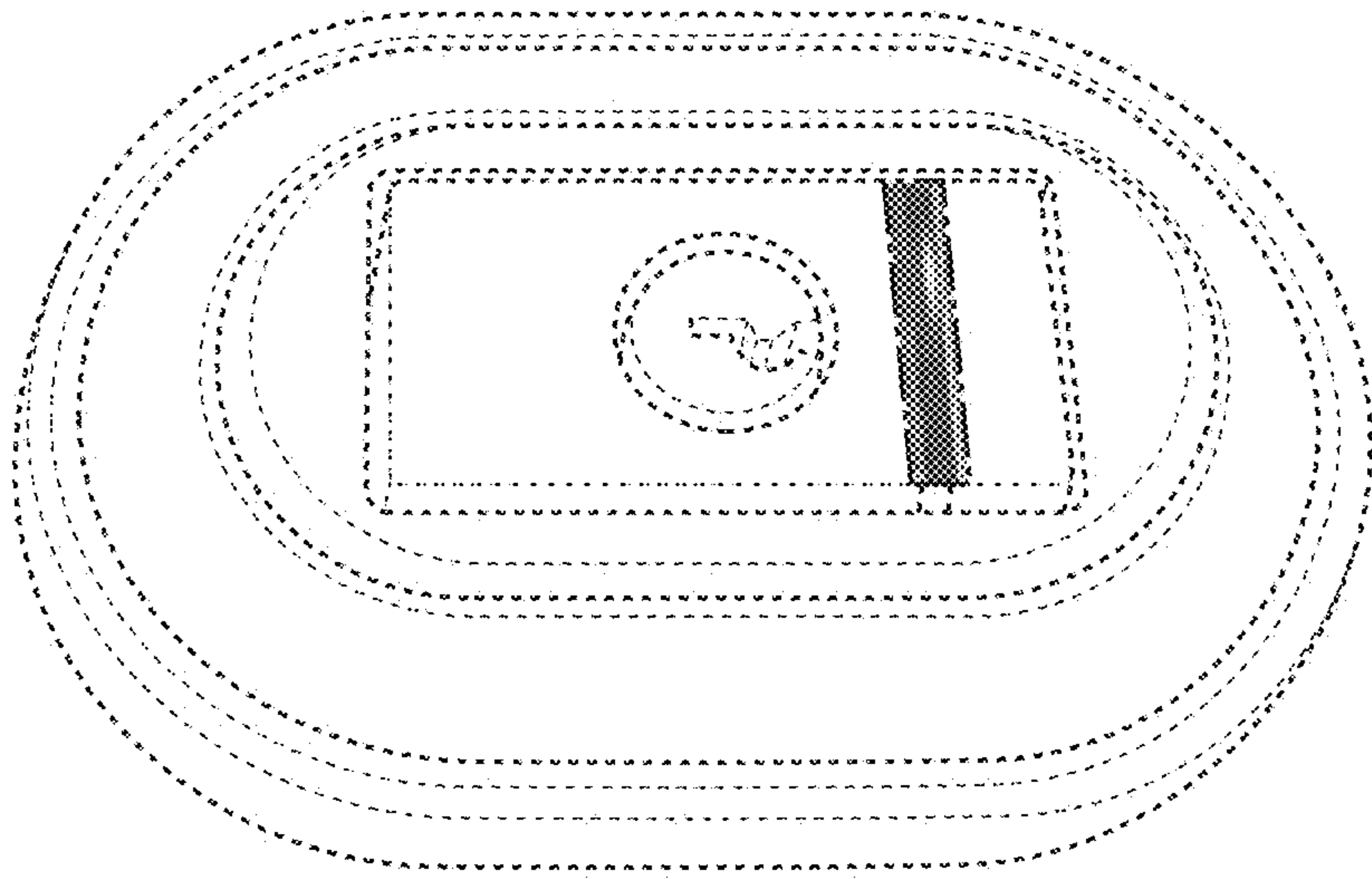

FIG. 20

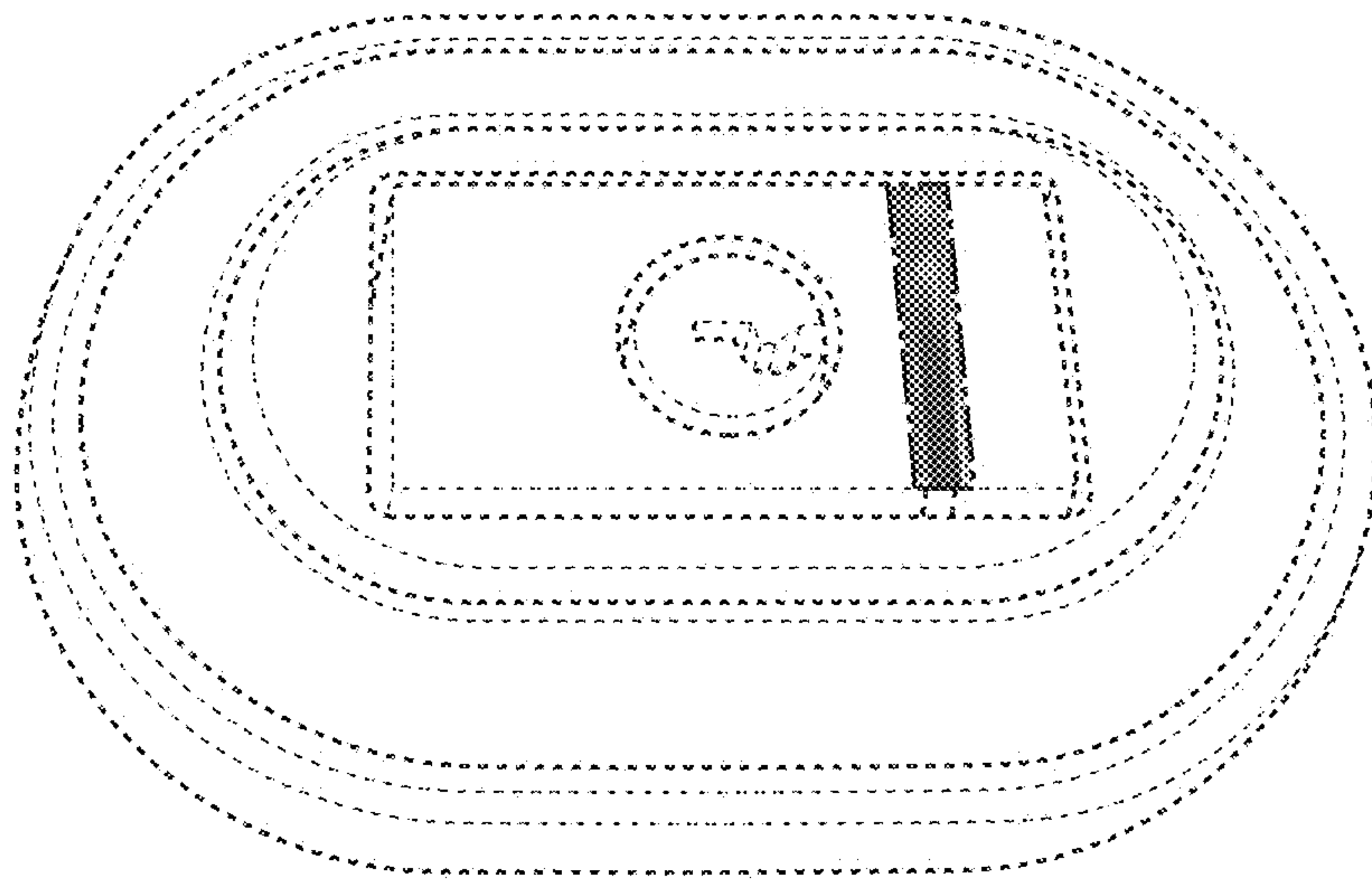

FIG. 19