

US00D927284S

(12) **United States Design Patent** (10) **Patent No.:** **US D927,284 S**
Atalla et al. (45) **Date of Patent:** **** Aug. 10, 2021**

- (54) **UNIVERSAL HINGE HANGER BRACKET** 4,903,629 A * 2/1990 Maudlin B63B 17/02
 114/361
 (71) Applicants: **Bill Martin Atalla**, Reno, NV (US); D371,950 S * 7/1996 Ressegger D8/323
Carolyn Marie Atalla, Washoe Valley, NV (US) D406,051 S * 2/1999 Ross D8/395
 D451,364 S * 12/2001 Borotto D8/323
 D665,449 S * 8/2012 Guirlinger D19/83
 (72) Inventors: **Bill Martin Atalla**, Reno, NV (US); D691,032 S * 10/2013 Chen D8/396
Carolyn Marie Atalla, Washoe Valley, NV (US) D760,583 S * 7/2016 Weilage D8/396
 D889,930 S * 7/2020 Shah D8/325
 D910,418 S * 2/2021 Walters D8/323

(**) Term: **15 Years**

* cited by examiner

(21) Appl. No.: **29/649,396**

Primary Examiner — Eliza Z Bennett-Hattan

(22) Filed: **May 29, 2018**

(74) *Attorney, Agent, or Firm* — Kerr IP Group, LLC

(51) **LOC (13) Cl.** **08-06**

(57) **CLAIM**

(52) **U.S. Cl.**

We claim the ornamental design for a universal hinge hanger bracket, as shown and described.

USPC **D8/323**

(58) **Field of Classification Search**

DESCRIPTION

USPC D8/323, 325–329
 CPC . Y10T 74/1293; Y10T 16/524; Y10T 16/525;
 Y10T 16/526; Y10T 16/5326; Y10T
 16/5358; Y10T 16/5383; Y10T 16/53864;
 Y10T 16/54025; Y10T 16/5478; Y10T
 29/4984; Y10T 403/315; Y10T
 403/32663; Y10T 403/459; Y10T 403/54;
 Y10T 16/5345; Y10T 16/53613; Y10T
 16/539; Y10T 24/1437

See application file for complete search history.

FIG. 1 is an isometric top view of a universal hinge hanger bracket, showing our new design;
 FIG. 2 is an isometric bottom view thereof;
 FIG. 3 is a front elevation view thereof;
 FIG. 4 is a left elevation view (at 90° from the front view) thereof;
 FIG. 5 is a back elevation view thereof;
 FIG. 6 is an enlarged isometric top view thereof;
 FIG. 7 is an enlarged top view thereof; and,
 FIG. 8 is an enlarged bottom view thereof.
 The broken lines shown represent unclaimed subject matter and form no part of the claimed design.

(56) **References Cited**

U.S. PATENT DOCUMENTS

- 3,106,994 A * 10/1963 Scott F16B 5/0291
 403/231
 3,313,009 A * 4/1967 Beckerer F16L 3/13
 248/74.2

1 Claim, 3 Drawing Sheets

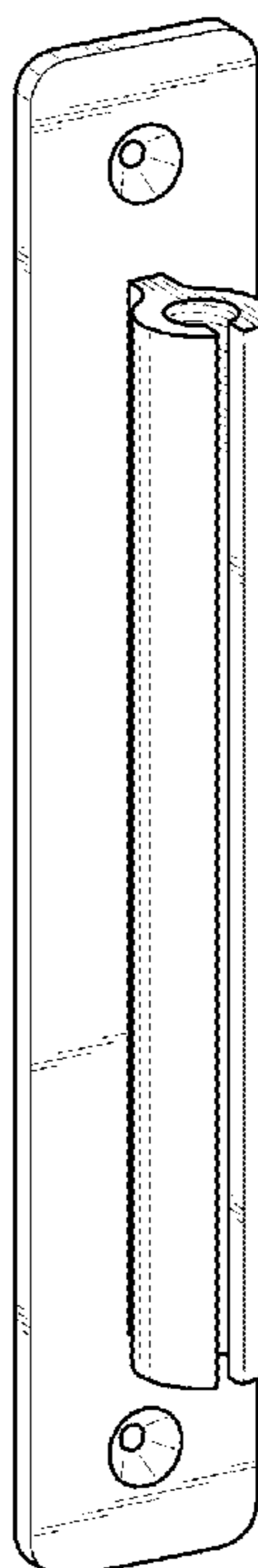

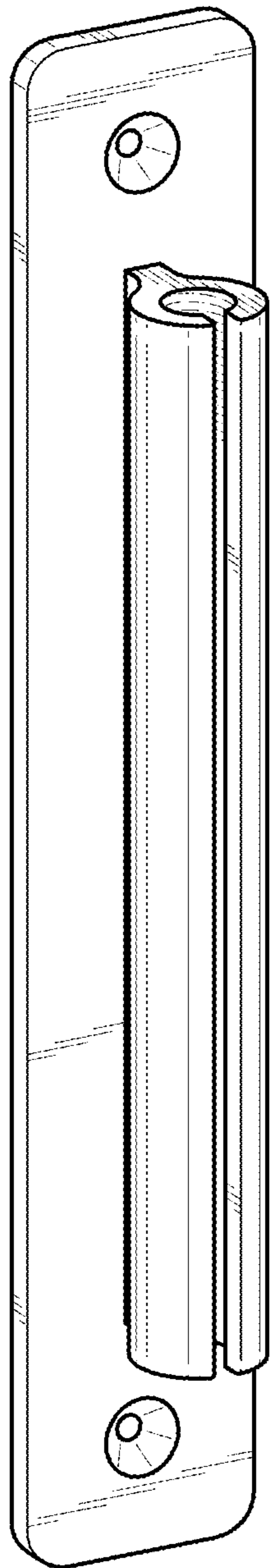

FIG. 1

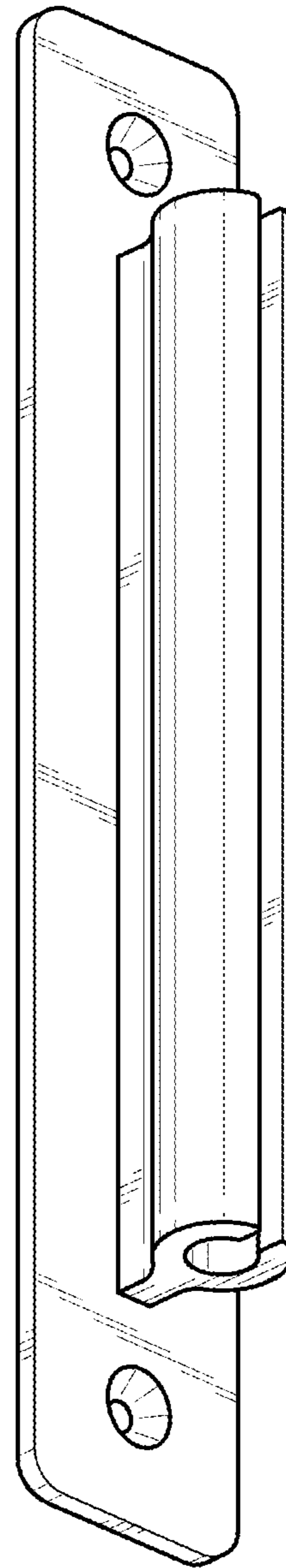

FIG. 2

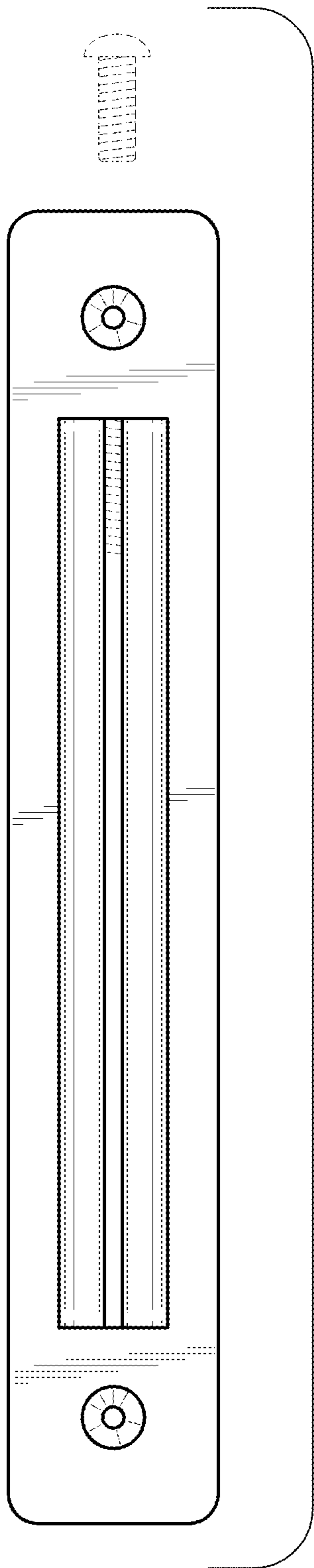

FIG. 3

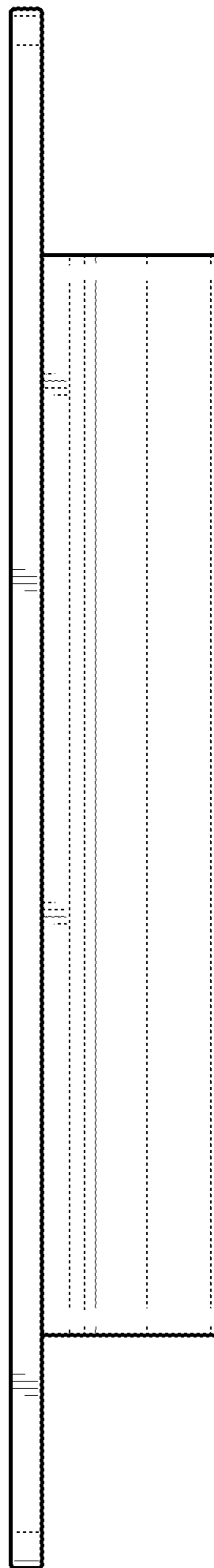

FIG. 4

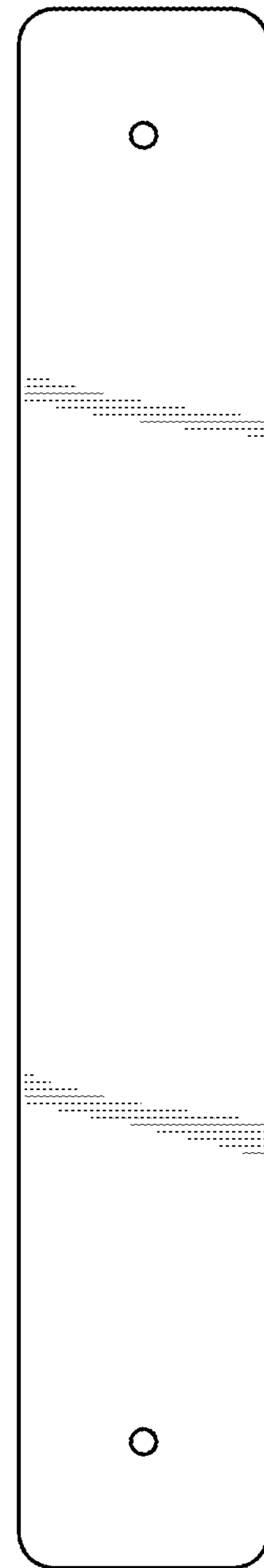

FIG. 5

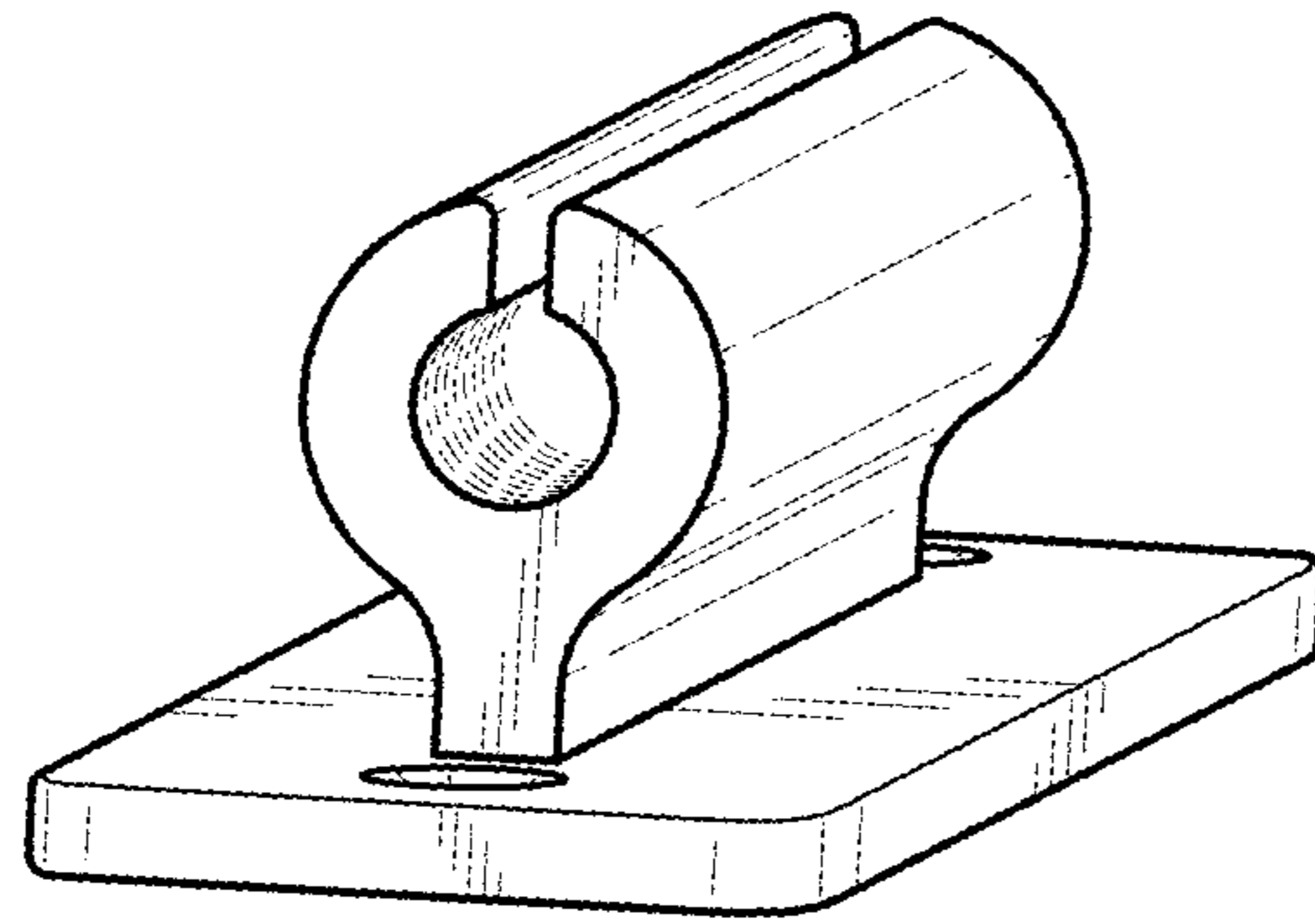

FIG. 6

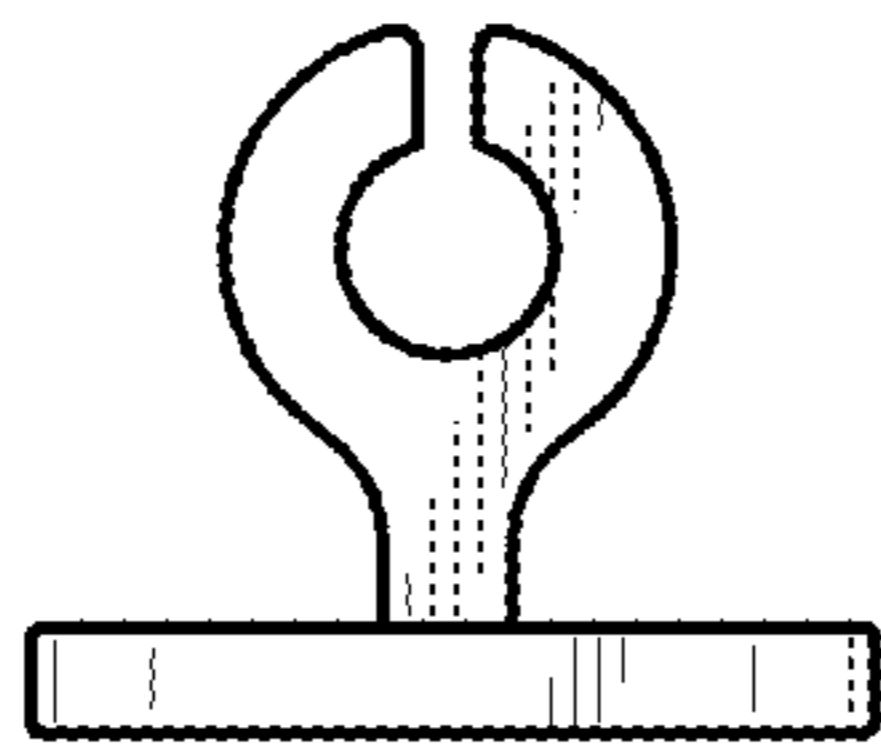

FIG. 7

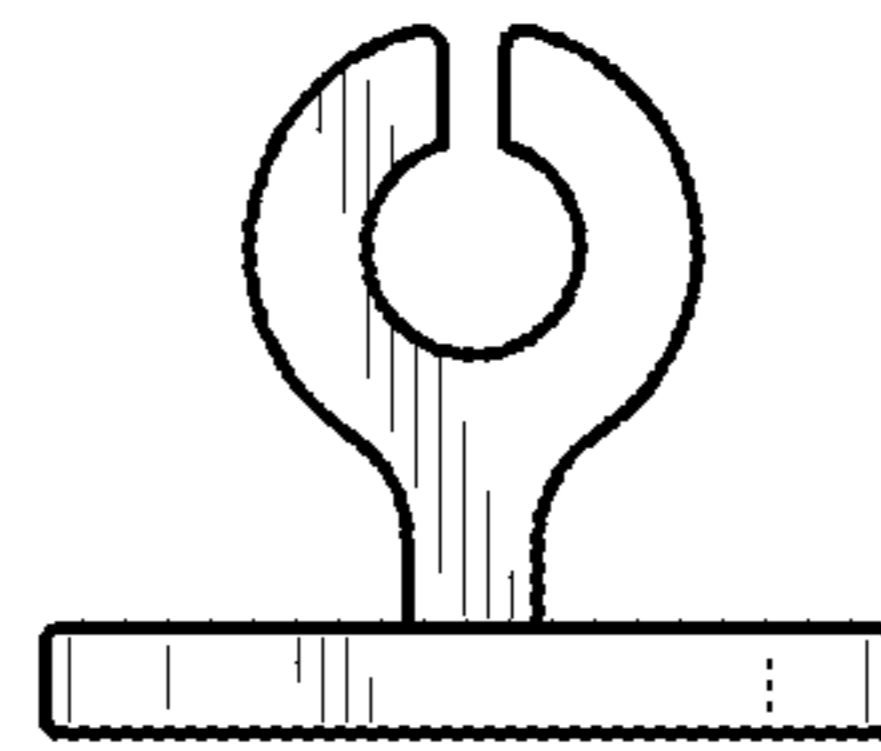

FIG. 8