



US00D927242S

(12) **United States Design Patent** (10) **Patent No.:** **US D927,242 S**
Sarnoff et al. (45) **Date of Patent:** **** *Aug. 10, 2021**

(54) **PAN**

(71) Applicant: **HFA, INC.**, Wheeling, IL (US)

(72) Inventors: **Brad Sarnoff**, Highland Park, IL (US);
Norton Sarnoff, Boca Raton, IL (US);
Raj Patel, Kildeer, IL (US)

(73) Assignee: **HFA, Inc.**, Wheeling, IL (US)

(*) Notice: This patent is subject to a terminal disclaimer.

(**) Term: **15 Years**

(21) Appl. No.: **29/708,703**

(22) Filed: **Oct. 9, 2019**

Related U.S. Application Data

(62) Division of application No. 29/640,931, filed on Mar. 19, 2018, now Pat. No. Des. 876,878.

(51) **LOC (13) Cl.** **07-02**

(52) **U.S. Cl.**
USPC **D7/359**

(58) **Field of Classification Search**
USPC D7/323, 338, 352, 354, 355, 356, 357,
D7/358, 359, 360, 361, 362, 363, 364,
(Continued)

(56) **References Cited**

U.S. PATENT DOCUMENTS

3,021,990 A * 2/1962 Duskey B6D 21/0233
206/519
3,144,974 A * 8/1964 Eichner B21D 22/201
220/608

(Continued)

FOREIGN PATENT DOCUMENTS

CA 181393 * 5/2018
JP 09051853 2/1997
JP 09051853 A * 2/1997

OTHER PUBLICATIONS

Full Curl Packaging, announced © 2018 [online], retrieved Oct. 1, 2020, retrieved from internet, <https://www.handi-foil.com/hfa/full-curl/>.*

(Continued)

Primary Examiner — Dana K Weiland
Assistant Examiner — Messina L Smith

(74) *Attorney, Agent, or Firm* — Adam K. Sacharoff;
Much Shelist, P.C.

(57) **CLAIM**

The ornamental design for a pan, as shown and described.

DESCRIPTION

FIG. 1 is a front side perspective view of a pan showing the new design;
FIG. 2 is a left side view thereof;
FIG. 3 is a right side view thereof;
FIG. 4 is a front view thereof;
FIG. 5 is a rear side view thereof;
FIG. 6 is a top plan view thereof;
FIG. 7 is a bottom plan view thereof;
FIG. 8 is a bottom perspective view thereof;
FIG. 9 is an enlarged front side perspective view of the circled portion of the pan in FIG. 1; and,
FIG. 10 is an enlarged bottom front side perspective view of the circled portion of the pan in FIG. 8.

The broken lines shown in the drawings depict portions of the pan that form no part of the claimed design. The broken lines encircling portions of the claimed design that are illustrated in the enlargements form no part of the claimed design.

1 Claim, 6 Drawing Sheets

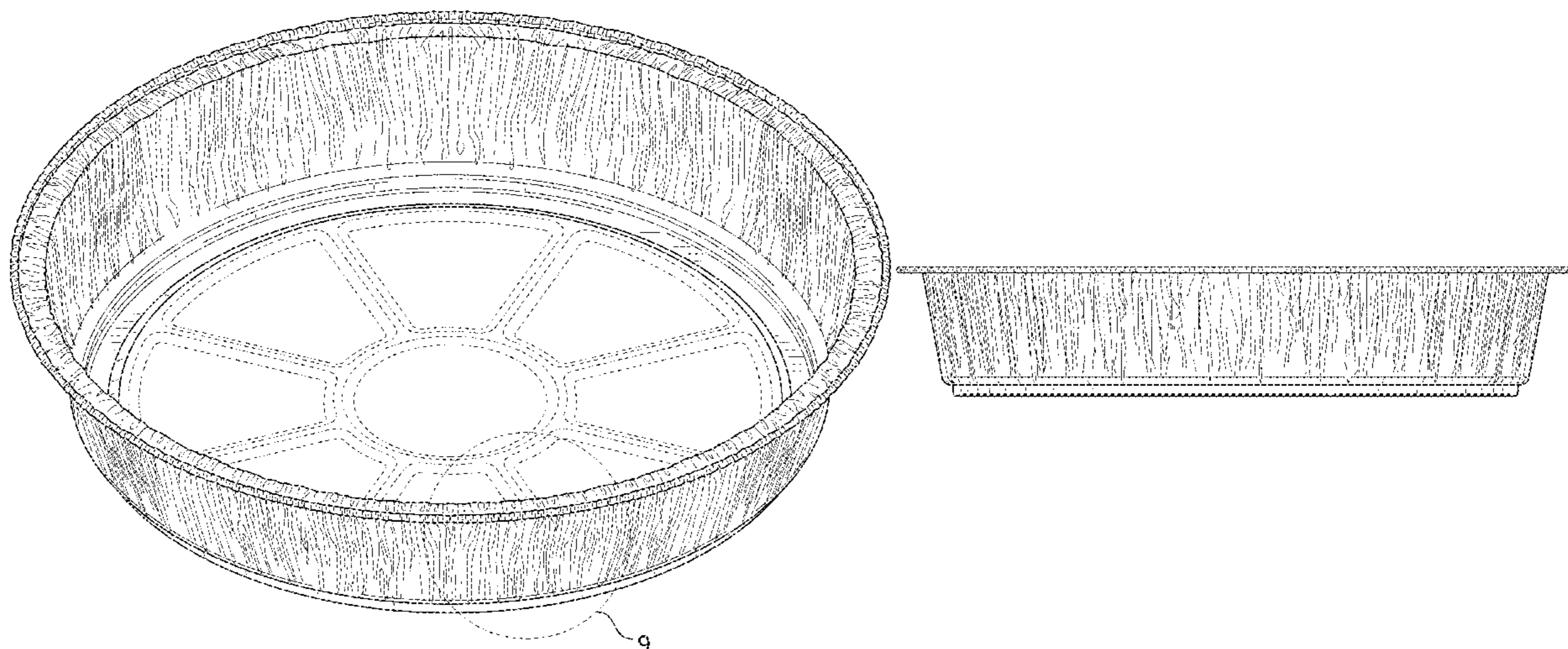

(58) **Field of Classification Search**

USPC D7/365, 366, 367, 402, 407, 409;
 D9/736, 749, 755, 758, 760, 456
 CPC .. A21B 3/00; A21B 3/13; A21B 3/131; A21B
 3/132; A21B 3/135; A21B 3/136; A21B
 3/137; A21B 3/15; A21B 5/00; A21B
 5/02; A21B 5/04; A47J 27/00; A47J
 36/00; A47J 36/02; A47J 36/06; A47J
 36/16; A47J 36/24; A47J 36/022; A47J
 36/027; A47J 37/00; A47J 37/01; A47J
 37/04; A47J 37/06; A47J 37/10; A47J
 37/07; A47J 37/0781; A47J 43/20

See application file for complete search history.

D807,704 S	1/2018	Epstein	
D810,495 S	2/2018	Yau	
D815,898 S	4/2018	Castriota	
D820,027 S	6/2018	Weernink	
D821,140 S	6/2018	Mirchandani	
D830,110 S	10/2018	Mirchandani	
D876,879 S *	3/2020	Sarnoff	D7/359
D878,140 S *	3/2020	Peretz	D7/354
D884,486 S *	5/2020	Chiang	D9/756
2013/0199380 A1	8/2013	Pugh	
2014/0238997 A1 *	8/2014	Sarnoff	A47J 47/14 220/573.1

(56) **References Cited**

U.S. PATENT DOCUMENTS

3,191,520 A *	6/1965	Halter	B65D 1/36 249/135
D321,809 S	11/1991	Zobrist	
D391,479 S *	3/1998	Poitras	D9/429
D391,850 S	3/1998	Krupa	
D438,466 S *	3/2001	Fletcher	D9/415
6,401,602 B1	6/2002	Lin	
D545,627 S	7/2007	Chatterton	
D553,819 S	10/2007	Brothers	
D554,316 S	10/2007	Brothers	
D598,744 S	8/2009	Sheilds	
D648,976 S	11/2011	Thurlaw	
D766,110 S	9/2016	Whitis	

OTHER PUBLICATIONS

Handi-Foil 9" Round Foil Take-Out/Cake Pan, announced Jul. 22, 2016 [online], retrieved Oct. 1, 2020, retrieved from internet, <https://www.amazon.com/Handi-Foil-Round-Take-Out-Disposable-Container/dp/B01IWKUNT2>.*

Handi-Foil 2046-00-200W 9" Round Foil Pan w/ Board Lid, announced © 2001-2018 [online], retrieved Oct. 1, 2020, retrieved from internet, <https://www.katom.com/428-204600200W.html>.*

HandiFoil 7" Takeout to-Go Round Disposable Aluminum Foil Pan Sets with Plastic Dome Lids, reviewed Mar. 12, 2016 [online], retrieved Sep. 11, 2019, retrieved from internet, https://www.amazon.com/Handi-Foil-Takeout-Disposable-Aluminum-Plastic/dp/BOOWOH MEGY/ref=cm_cr arp_d_product_top?ie=UTF8 (Year: 2016).

Office Action, U.S. Appl. No. 29/640,931, copending parent application; dated Sep. 18, 2019.

* cited by examiner

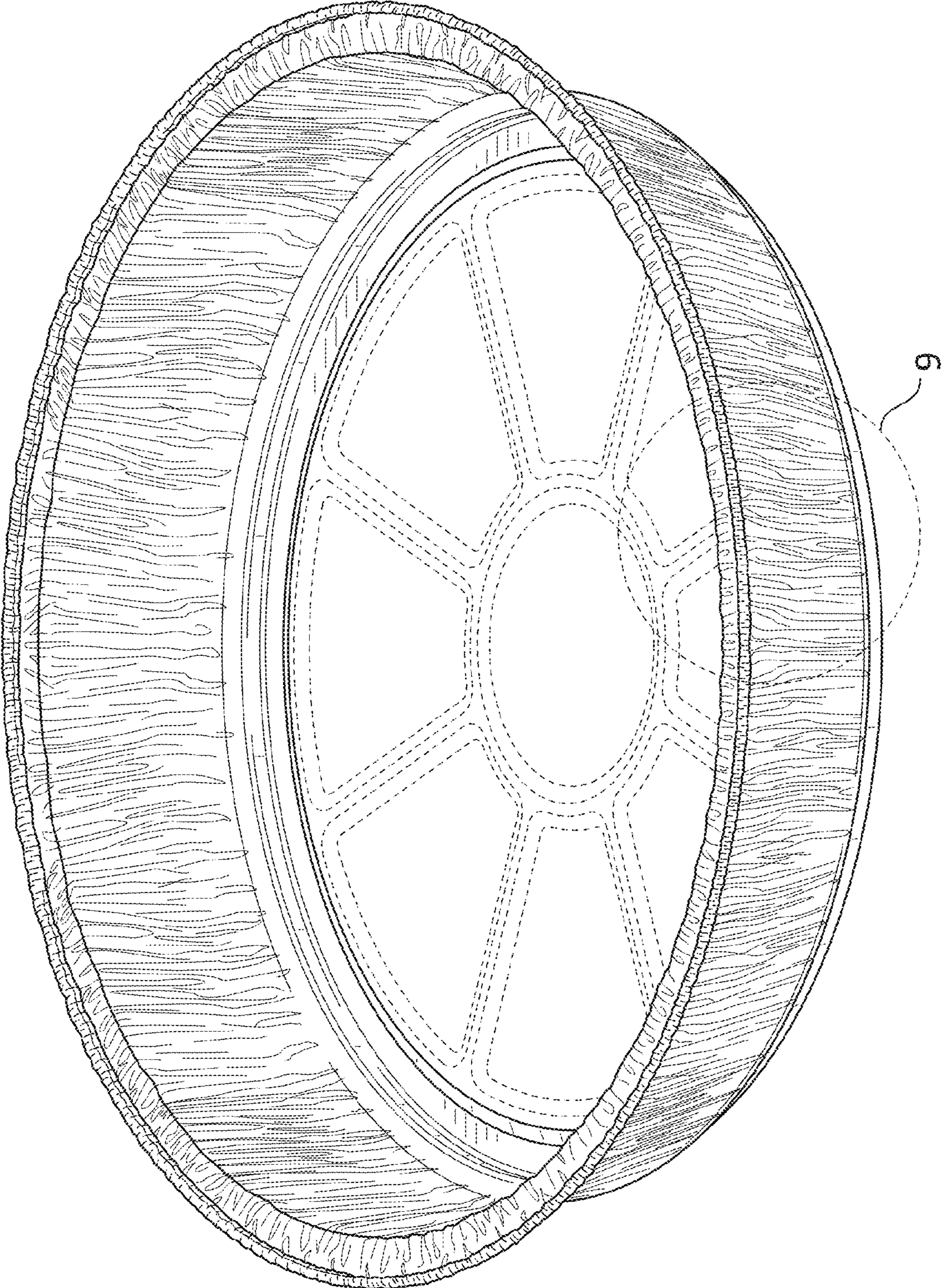

FIG. 1

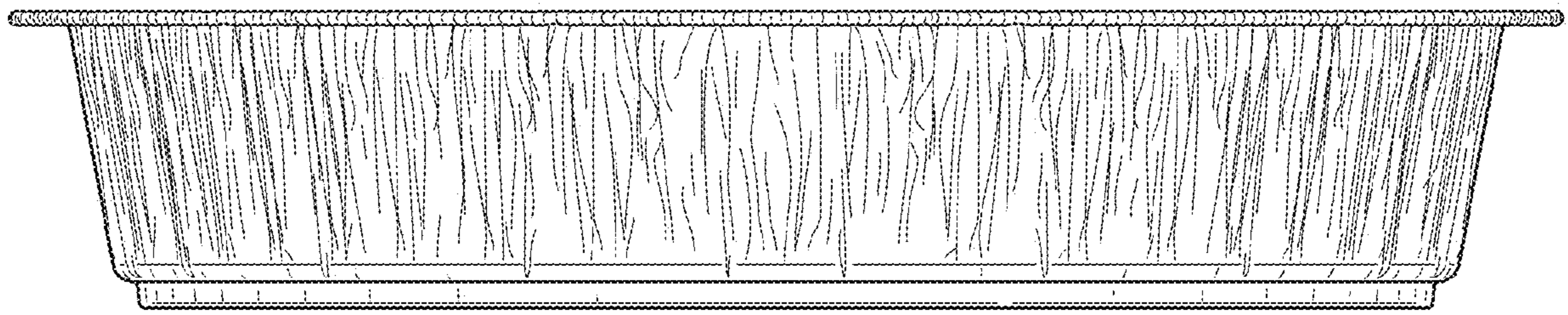

FIG. 2

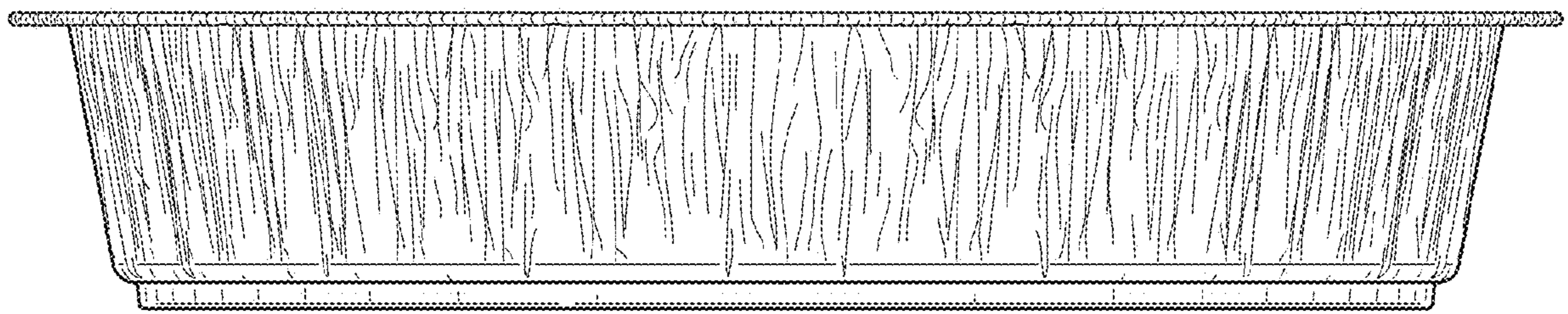

FIG. 3

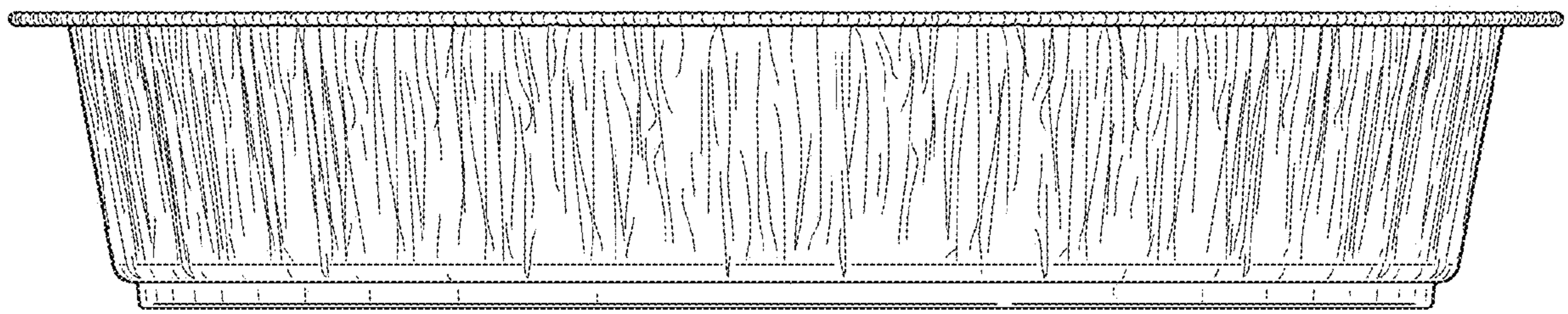

FIG. 4

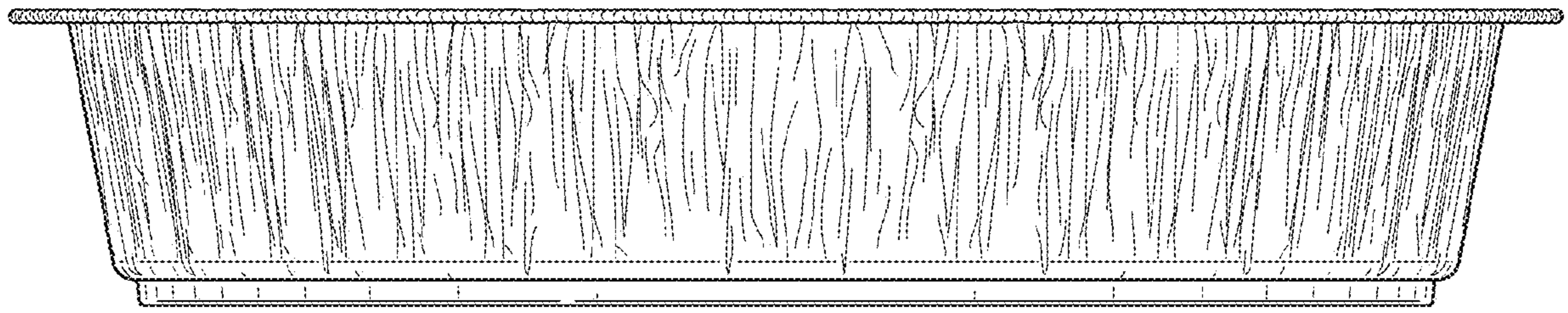

FIG. 5

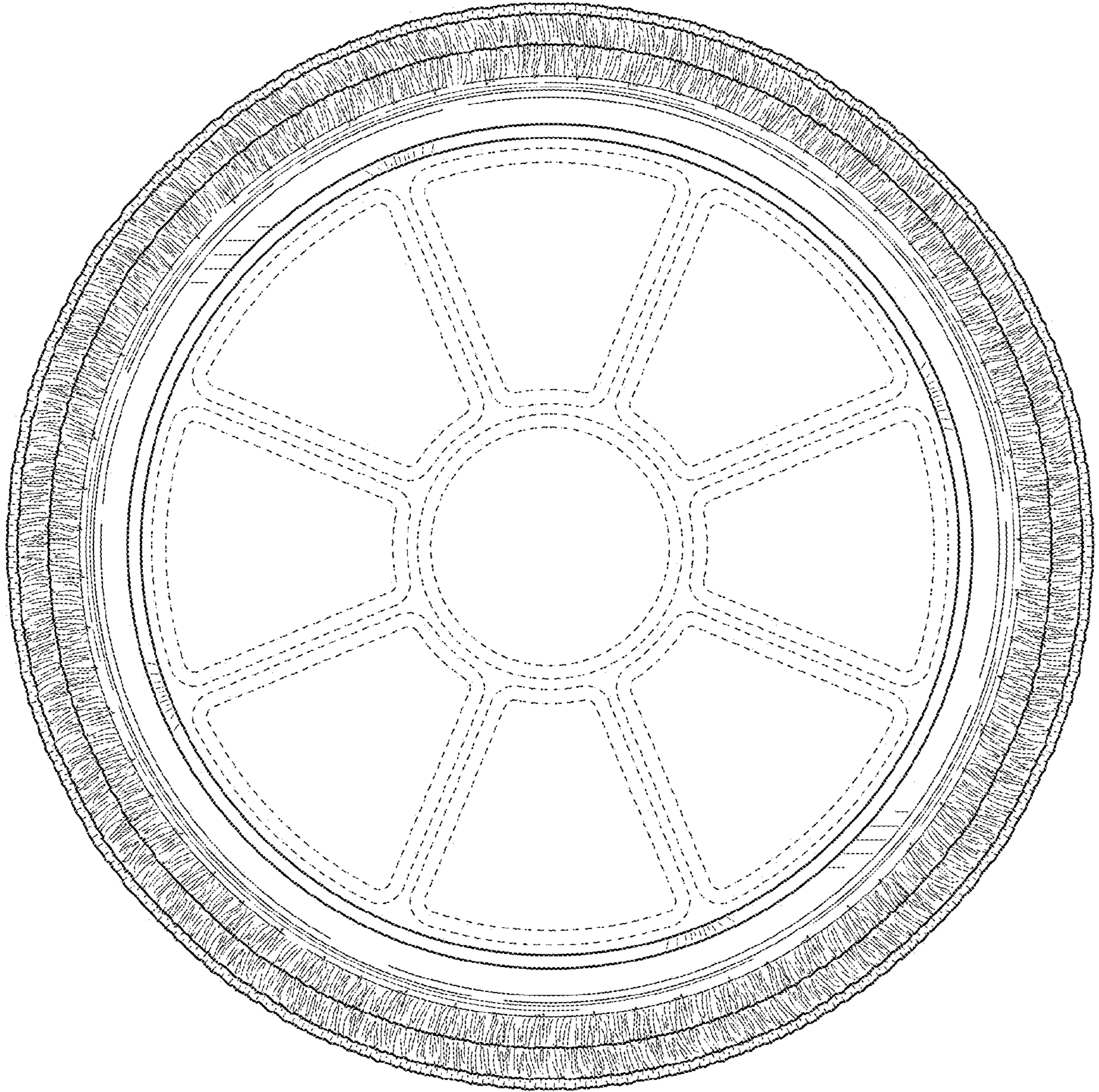

FIG. 6

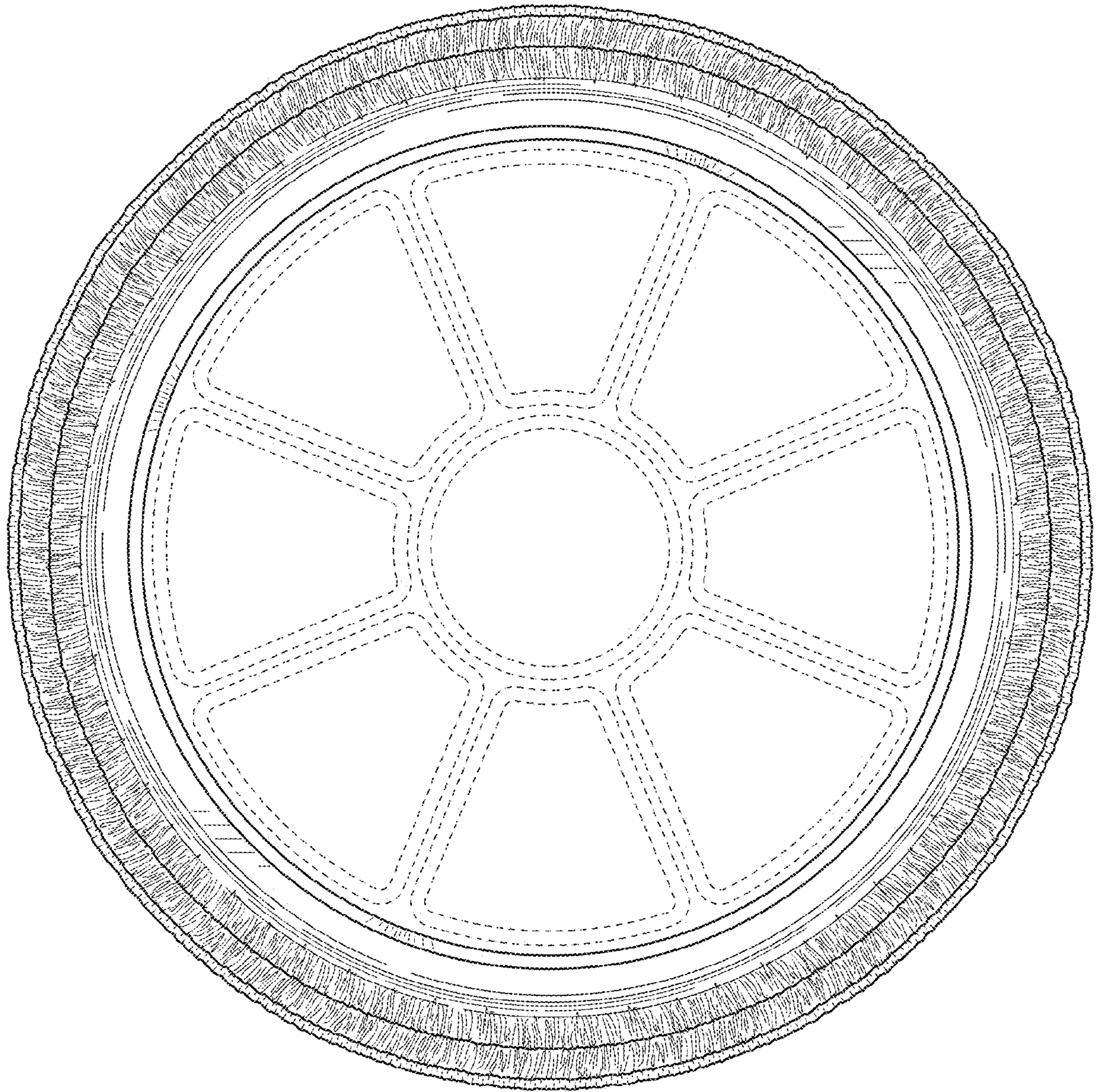

FIG. 7

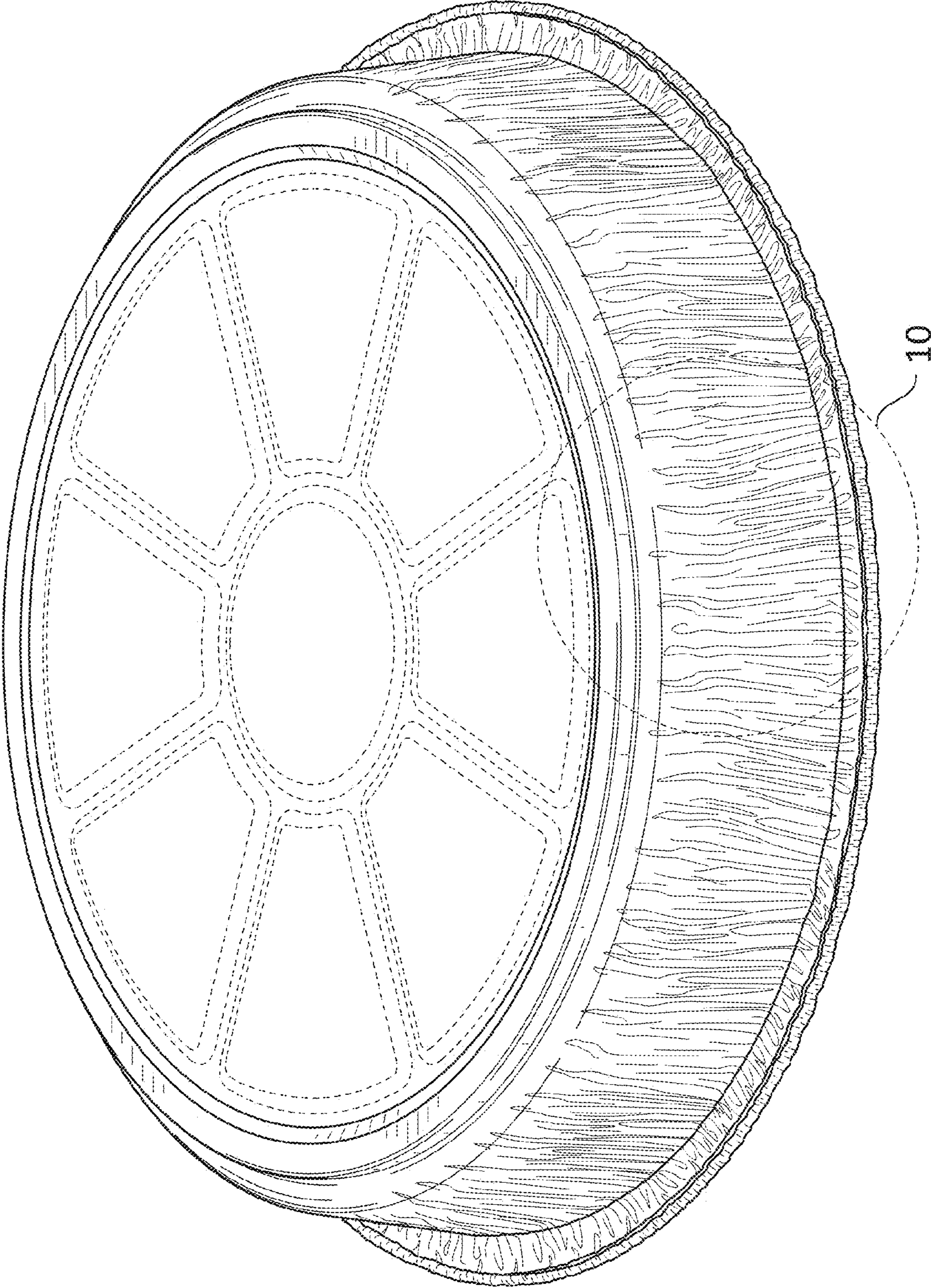

FIG. 8

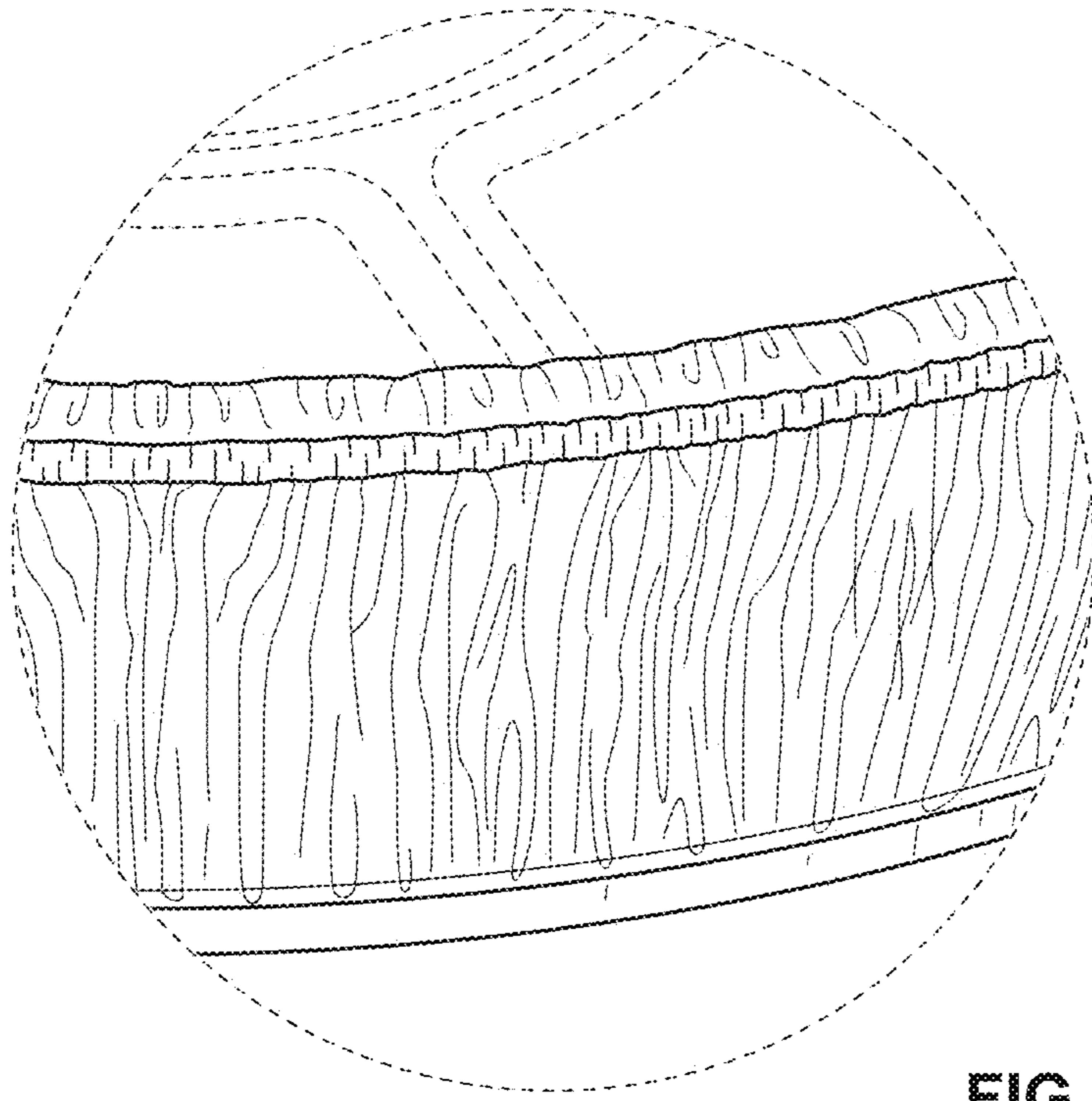

FIG. 9

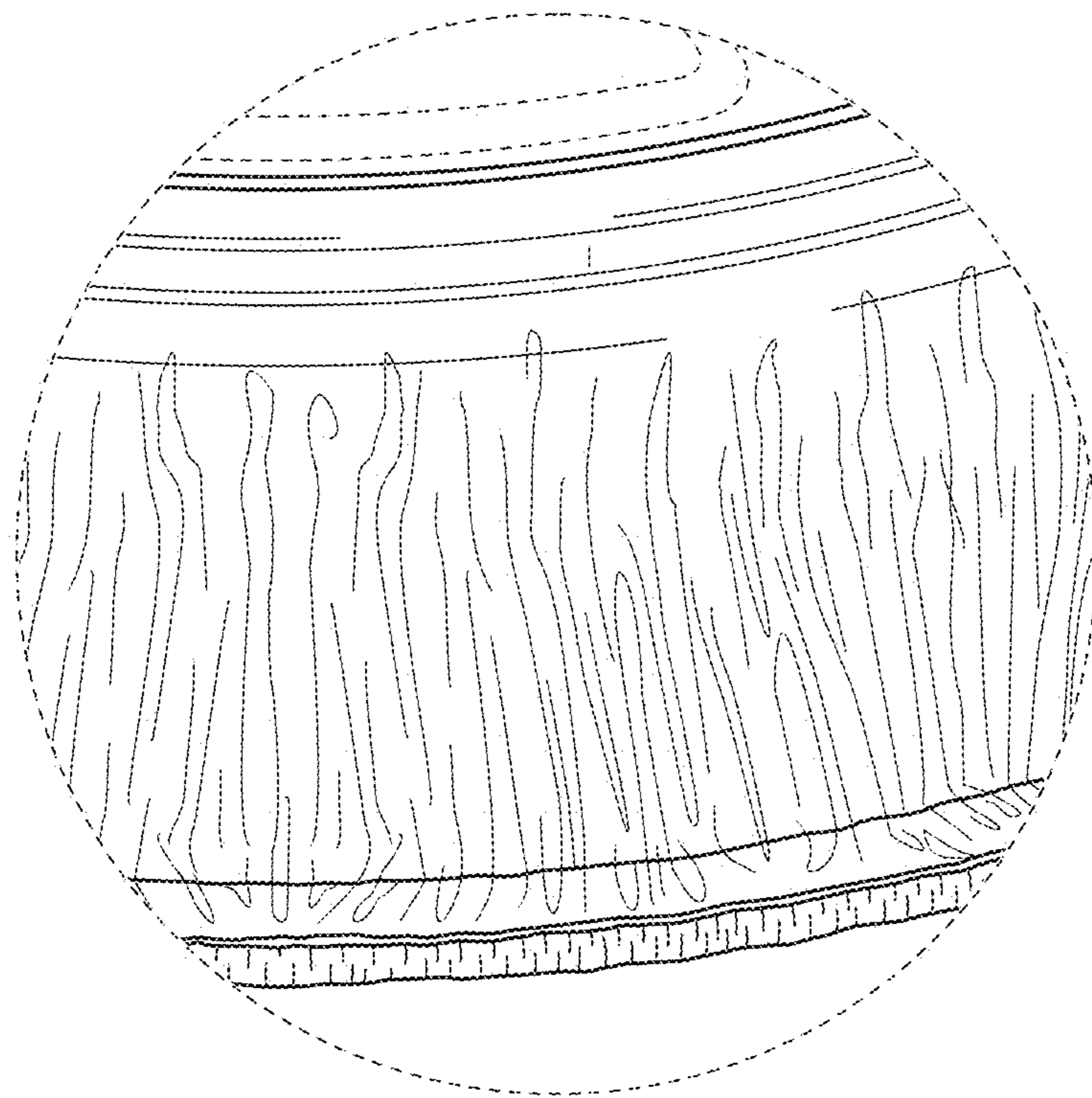

FIG. 10