



US00D927217S

(12) **United States Design Patent** (10) **Patent No.:** **US D927,217 S**
Holzmann et al. (45) **Date of Patent:** **** Aug. 10, 2021**

(54) **TOWEL DISPENSER**

- (71) Applicant: **Bradley Corporation**, Menomonee Falls, WI (US)
- (72) Inventors: **Simon Holzmann**, Zorneding (DE); **Stefan Hillenmayer**, Munich (DE); **Ning Zhou**, Munich (DE); **Laura Beth Stang**, Mukwonago, WI (US)
- (73) Assignee: **Bradley Corporation**, Menomonee Falls, WI (US)
- (**) Term: **15 Years**
- (21) Appl. No.: **29/710,947**
- (22) Filed: **Oct. 28, 2019**

Related U.S. Application Data

- (63) Continuation-in-part of application No. 29/708,038, filed on Oct. 2, 2019.
- (51) **LOC (13) Cl.** **20-02**
- (52) **U.S. Cl.**
USPC **D6/522**
- (58) **Field of Classification Search**
USPC D6/515-523, 545; 211/13.1, 173, 180, 211/45, 86.01, 87.02, 87.01; 248/309.1, 248/309.2, 904; 242/570, 590; 206/225, 206/233, 389, 391, 77.1; 221/26, 33, 221/282, 283, 14, 92, 105; 222/173, 180, 222/281-282
- CPC A47K 10/424; A47K 10/42; A47K 10/24; A47K 5/1217; A47K 5/02; A47K 10/025; A47K 10/10; A47K 10/04; A47K 1/09; A47K 17/003; A47F 1/085; A47F 7/163; A47F 7/16; B65H 75/141; B65D 83/267; B65D 23/003; B65D 83/40; B65D 77/065;

(Continued)

(56) **References Cited**

U.S. PATENT DOCUMENTS

- D530,125 S * 10/2006 Vignot D6/545
D530,555 S 10/2006 Karraker et al.
(Continued)

OTHER PUBLICATIONS

EMCO Liquid Soap Dispenser, <https://www.emco-bath.com/en/products/accessories/details/product/show/fluessigseifenspender-manuell-en/3521-001-04-chrome-en.html>.
(Continued)

Primary Examiner — Nathan M Johnston
(74) *Attorney, Agent, or Firm* — Boyle Fredrickson, S.C.

(57) **CLAIM**

The ornamental design for a towel dispenser, substantially as shown and described.

DESCRIPTION

FIG. 1 is a front, raised perspective view of a towel dispenser according to a first embodiment of the invention; FIG. 2 is a front view of the towel dispenser of FIG. 1; FIG. 3 is a rear view of the towel dispenser of FIG. 1; FIG. 4 is a right side view of the towel dispenser of FIG. 1; FIG. 5 is a left side view of the towel dispenser of FIG. 1; FIG. 6 is a top view of the towel dispenser of FIG. 1; FIG. 7 is a bottom view of the towel dispenser of FIG. 1; FIG. 8 is a front, lowered perspective view of the towel dispenser of FIG. 1; FIG. 9 is a front, raised perspective view of a towel dispenser according to a second embodiment of the invention, the second embodiment being similar to the first embodiment but with a transparent lower section; and, FIG. 10 is a front, lowered perspective of the towel dispenser of FIG. 9.

The dashed broken lines in the drawings show environmental structures and form no part of the claimed design.

1 Claim, 10 Drawing Sheets

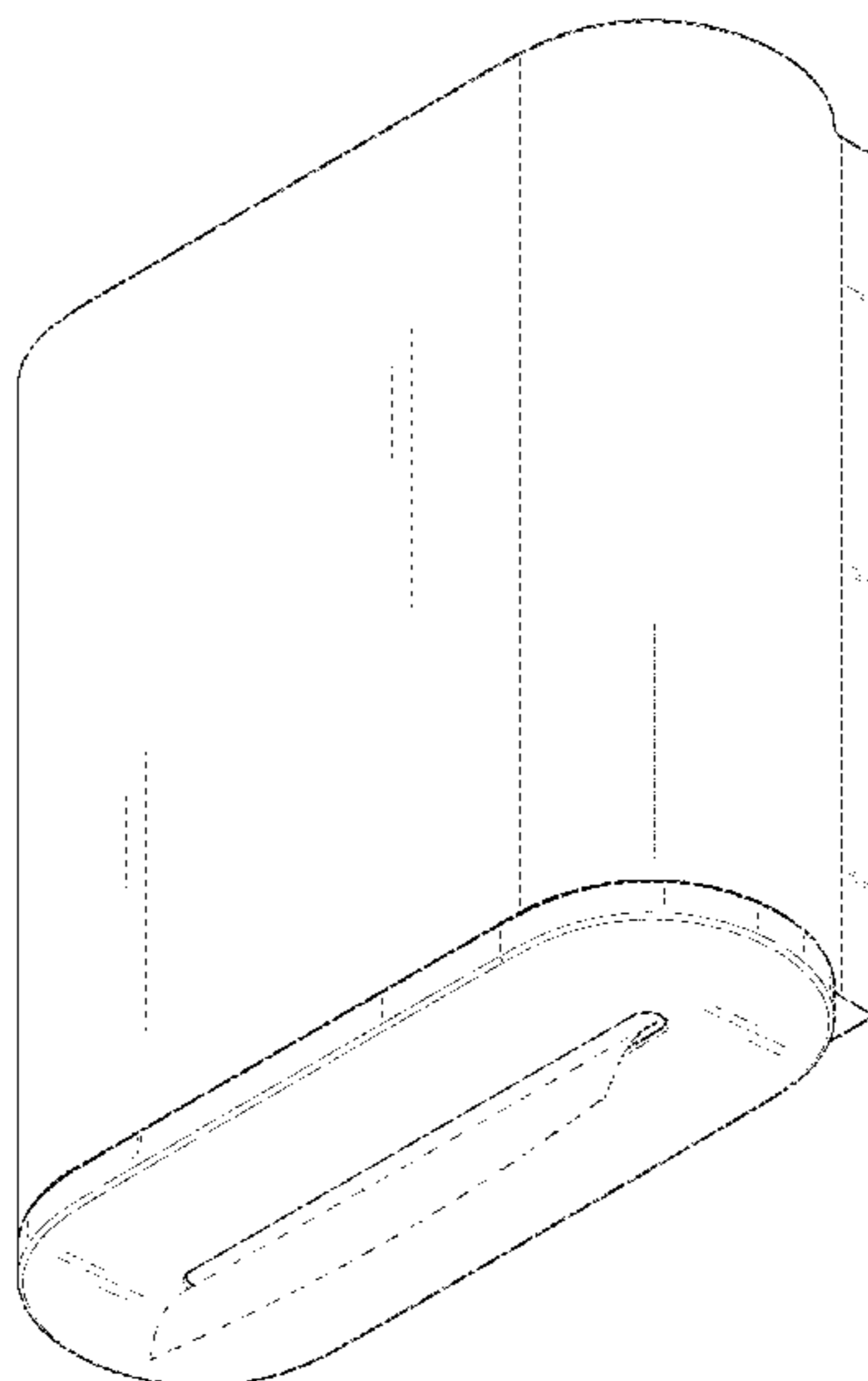

(58) **Field of Classification Search**

CPC B65D 35/242; B65D 85/672; B65D 83/08;
B65D 83/05; B65D 85/04; B67D 3/0029;
B67D 1/07; A61C 5/06

See application file for complete search history.

(56) **References Cited**

U.S. PATENT DOCUMENTS

D615,329 S 5/2010 Meyerhoffer
D616,683 S 6/2010 Law et al.
D624,340 S 9/2010 Benedetti
D634,142 S 3/2011 Meyerhoffer
D634,953 S 3/2011 Meyerhoffer
D641,578 S 7/2011 Meyerhoffer
D648,585 S 11/2011 Meyerhoffer
D653,888 S 2/2012 Velazquez et al.
D662,342 S * 6/2012 Daniel D6/545
D677,085 S * 3/2013 Velazquez D6/518
D686,840 S 7/2013 Mackay
D687,653 S 8/2013 Giovannoni
D695,542 S * 12/2013 Niada D6/518
D696,041 S 12/2013 Mackay
8,622,242 B2 * 1/2014 Pelfrey G07C 9/00896
222/23
D703,463 S 4/2014 Giovannoni
D726,443 S 4/2015 Giovannoni
D726,444 S 4/2015 Giovannoni
D726,445 S 4/2015 Giovannoni
D740,587 S * 10/2015 Sun Ting Kung D6/518
D790,873 S 7/2017 Ku et al.
D796,866 S 9/2017 Johnson
D796,867 S 9/2017 Johnson

D796,868 S 9/2017 Johnson
D798,080 S * 9/2017 Duncan D6/542
D802,329 S * 11/2017 Brownley D6/545
D806,435 S * 1/2018 Santoro D6/545
D809,819 S 2/2018 Johnson
D811,120 S 2/2018 Johnson
D811,770 S * 3/2018 Brownley D6/545
D830,636 S 10/2018 Loong
D831,377 S * 10/2018 Blick D6/545
D840,171 S 2/2019 Buell et al.
D840,712 S 2/2019 Buell et al.
D840,713 S 2/2019 Buell et al.
D855,348 S 8/2019 Buell et al.
D869,193 S 12/2019 Peterson
D871,672 S 12/2019 Hongfei
D901,930 S * 11/2020 Reilly D6/542
2018/0206684 A1 * 7/2018 Tedesco A47K 10/3818

OTHER PUBLICATIONS

EMCO Liquid Soap Dispenser, <https://www.emco-bath.com/en/products/accessories/details/product/show/fluessigseifenspender-sensorgesteuert-en/3521-001-03-chrome-en.html>.
EMCO Paper Towel Dispenser, <https://www.emco-bath.com/en/products/accessories/details/product/show/papierspender-en/3549-001-00-chrome-en.html>.
EMCO Paper Holder, <https://www.emco-bath.com/en/products/accessories/details/product/show/papierhalter-2-fach-en/3500-001-04-chrome-en.html>.
EMCO Paper Holder, <https://www.emco-bath.com/en/products/accessories/details/product/show/papierhalter-3-fach-en/3500-001-05-chrome-en.html>.

* cited by examiner

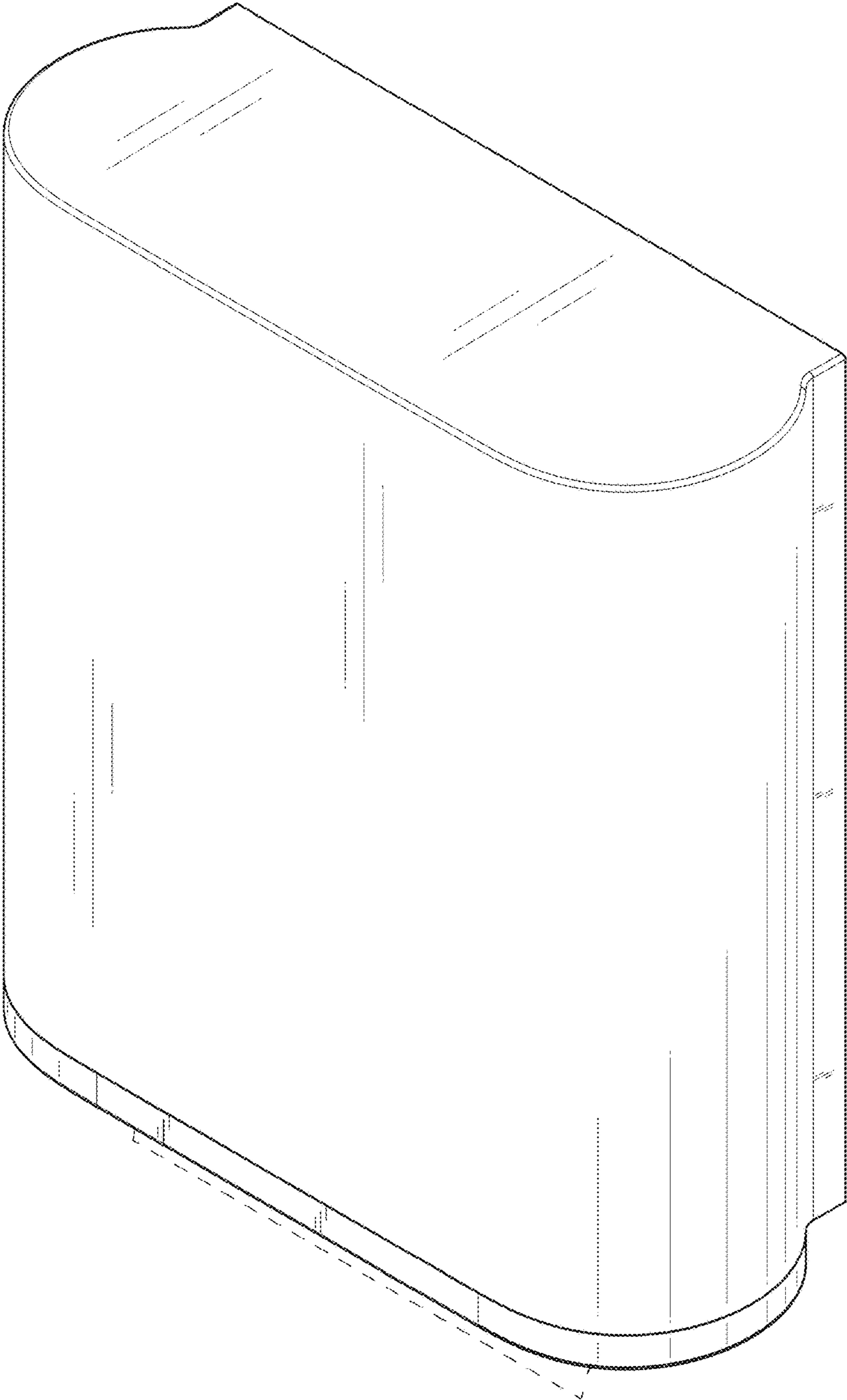

FIG. 1

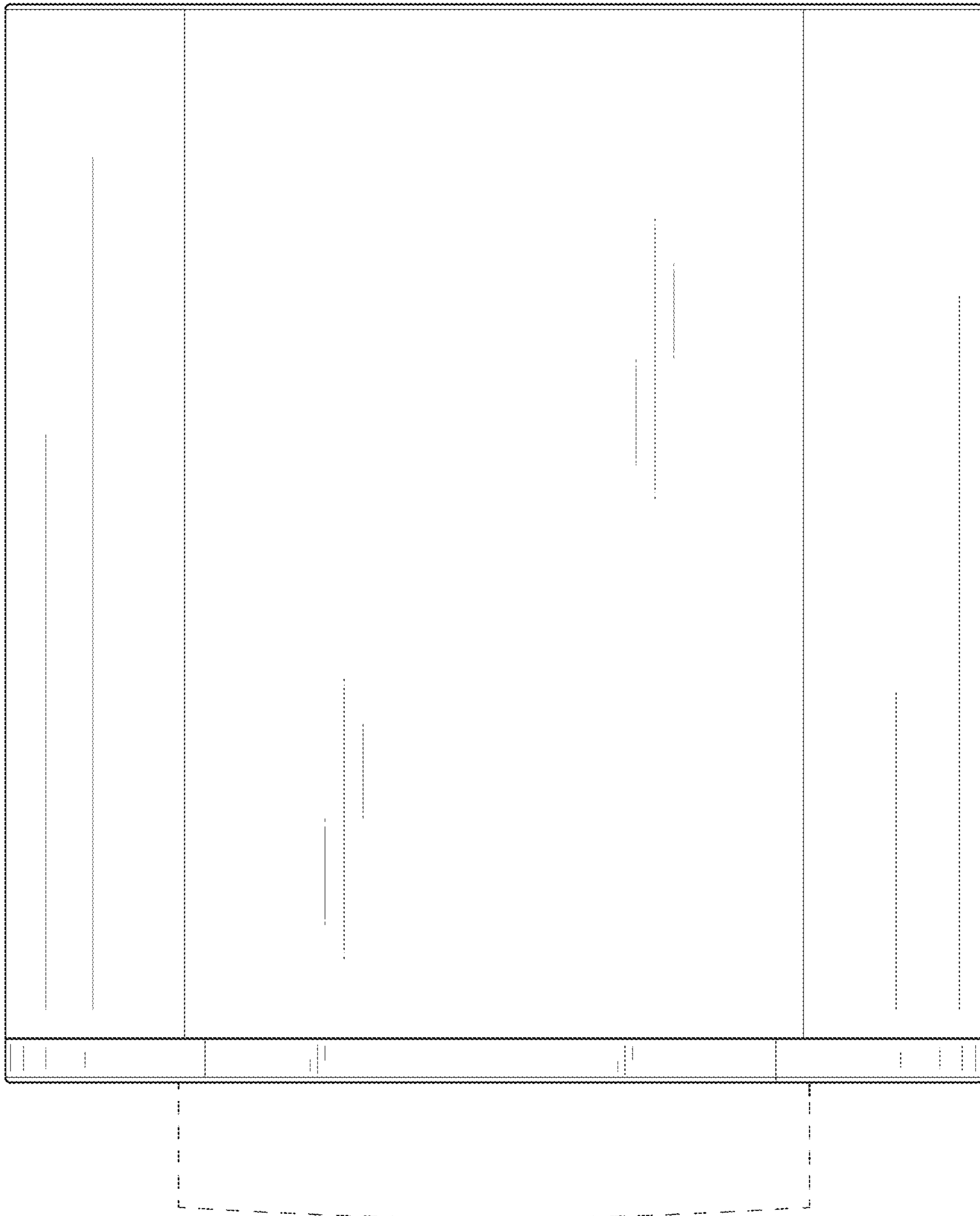

FIG. 2

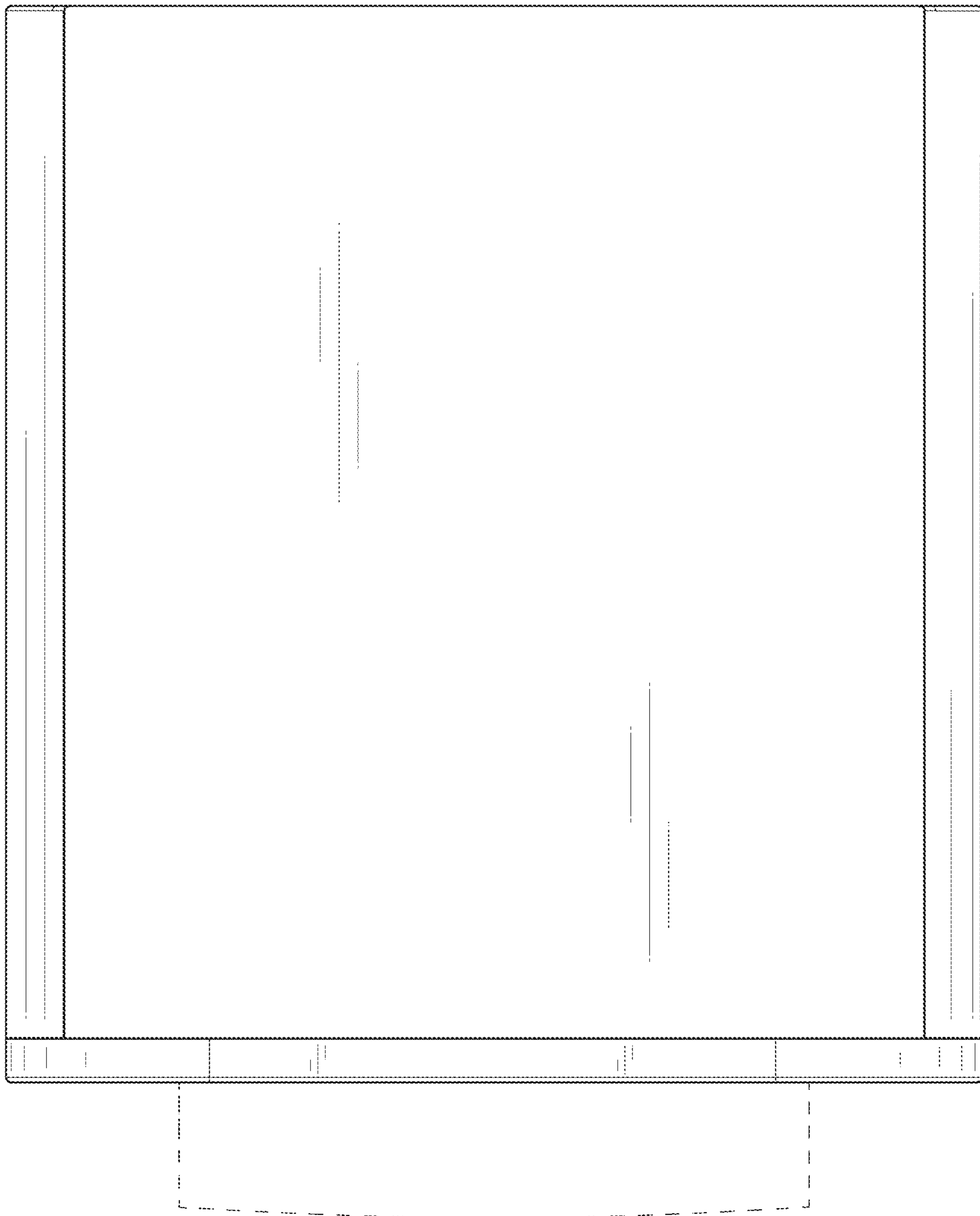

FIG. 3

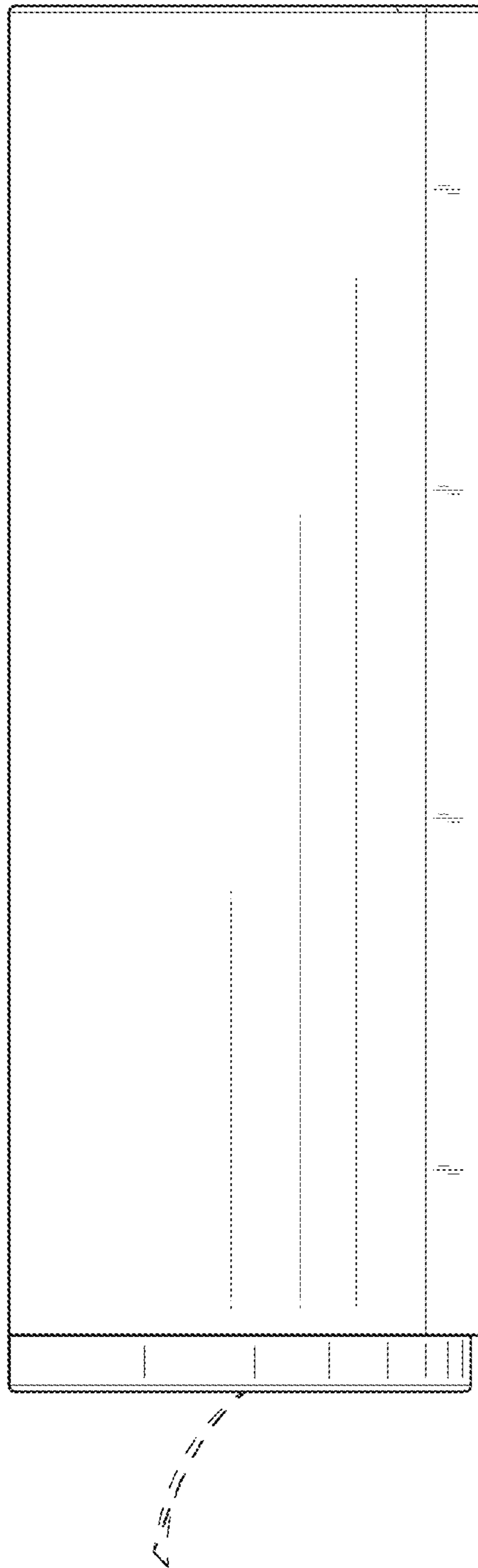

FIG. 4

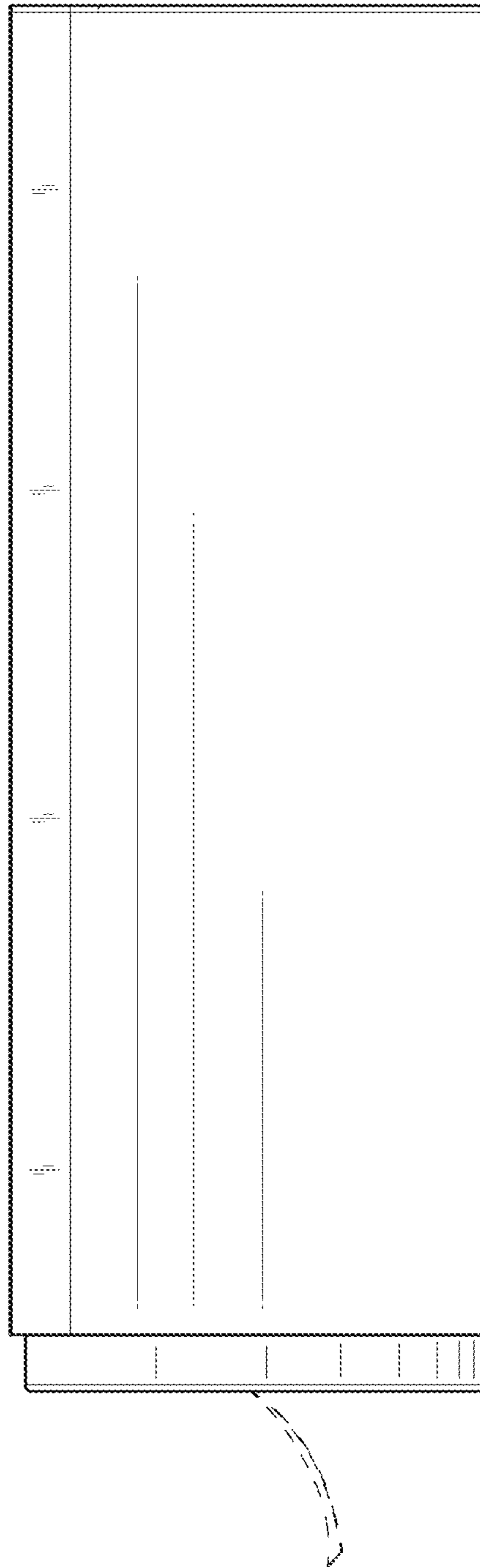

FIG. 5

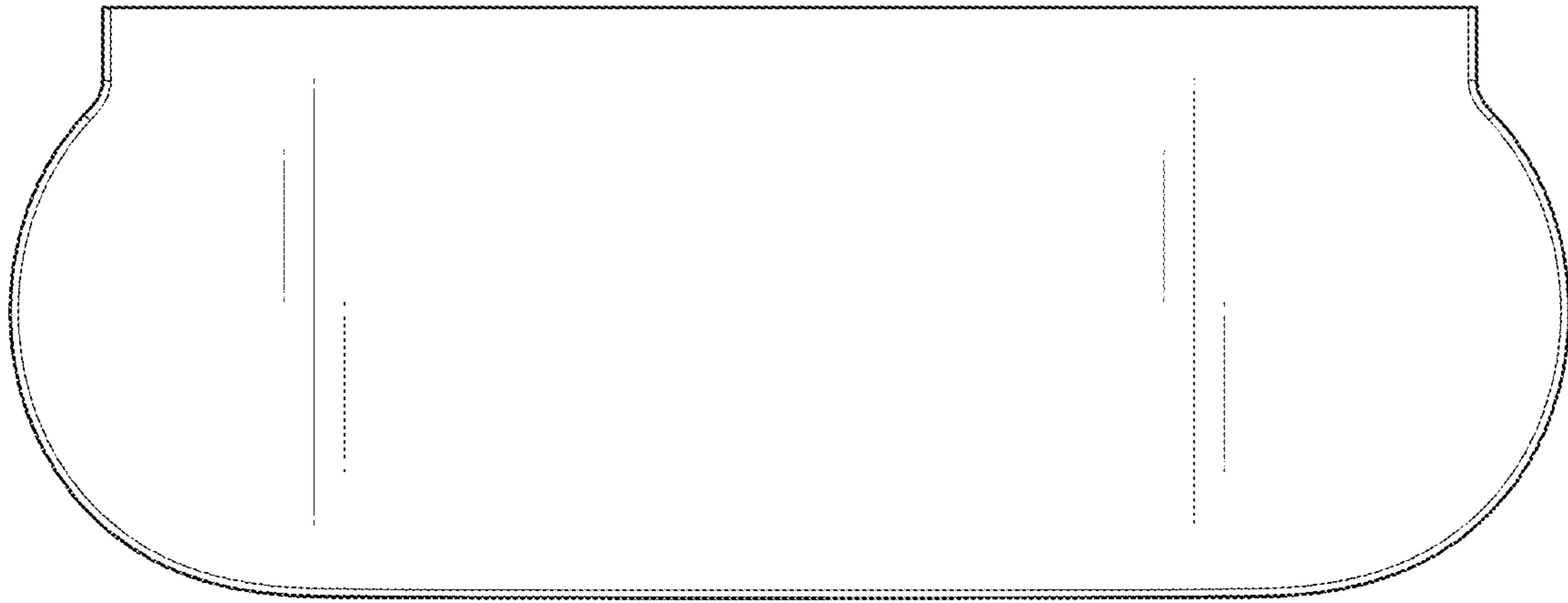

FIG. 6

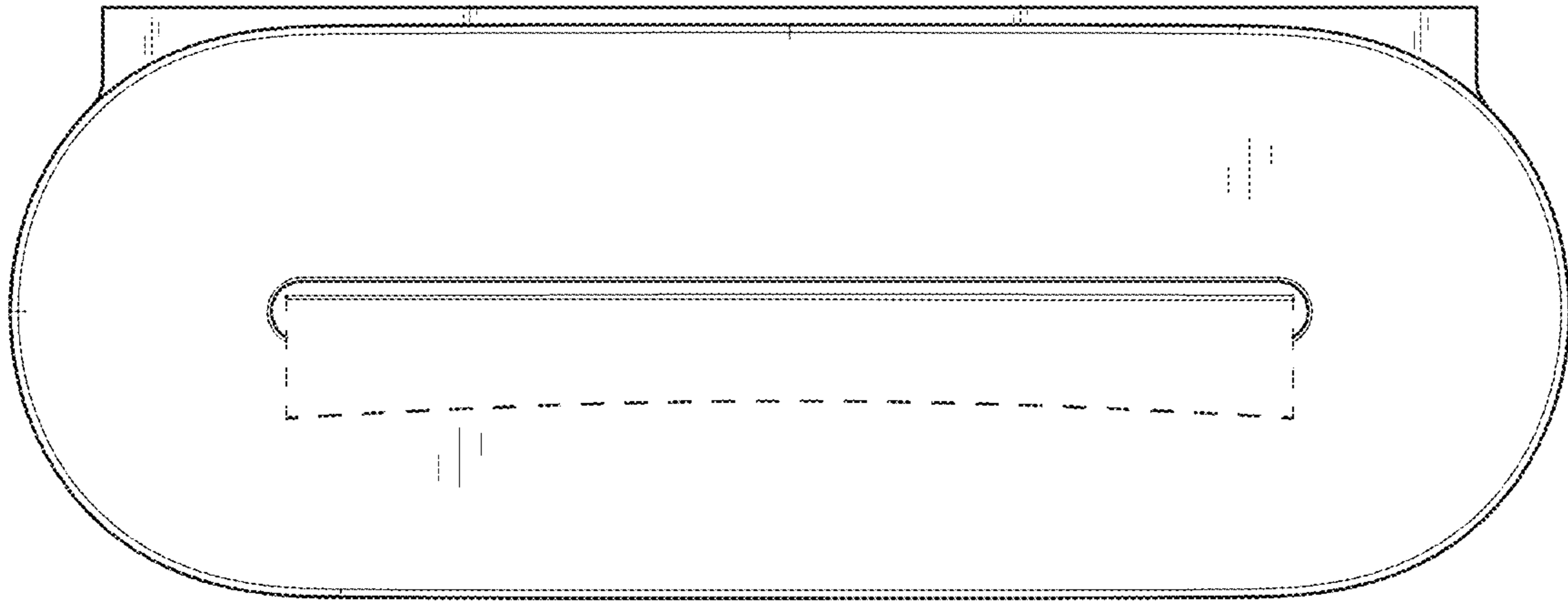

FIG. 7

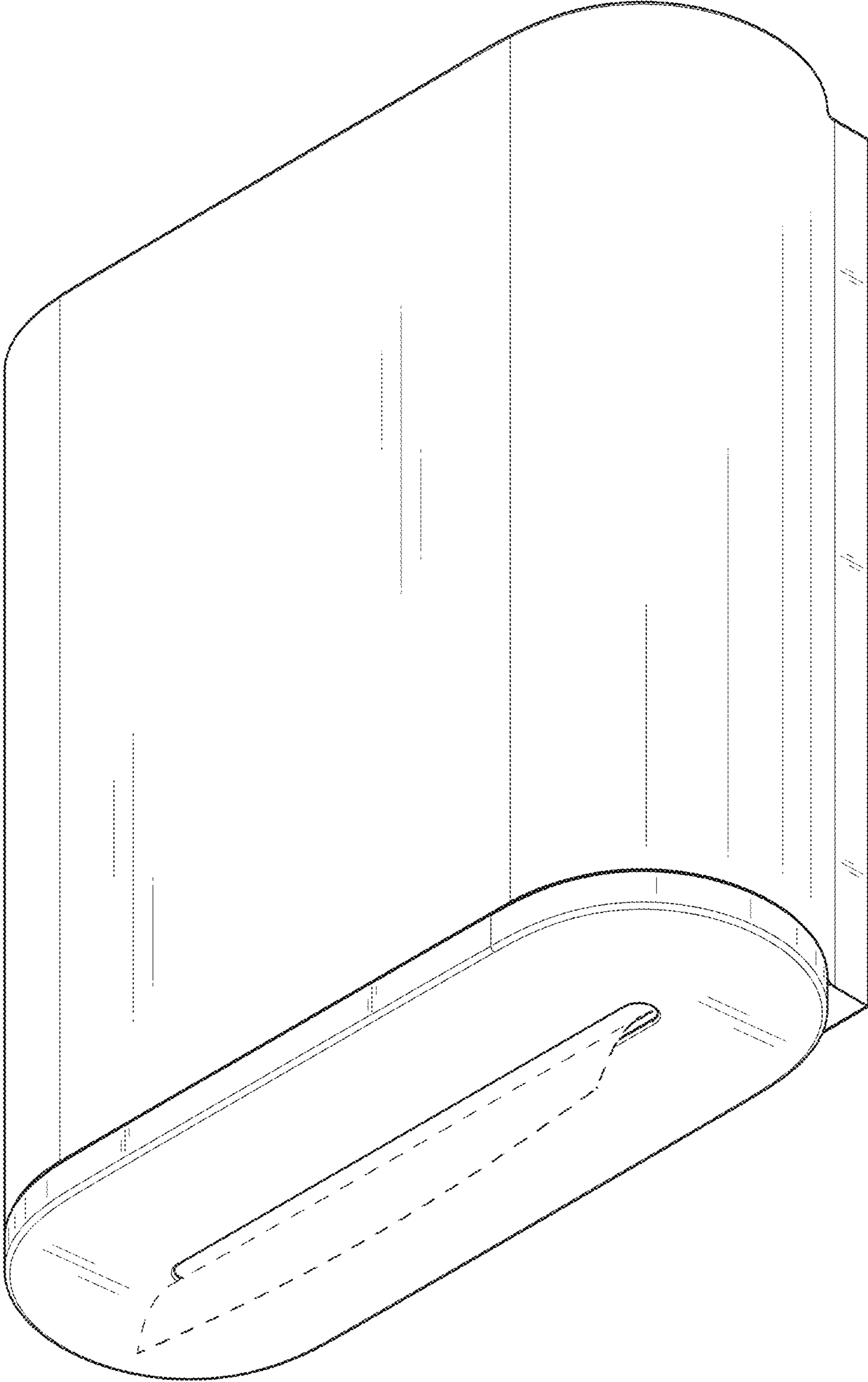

FIG. 8

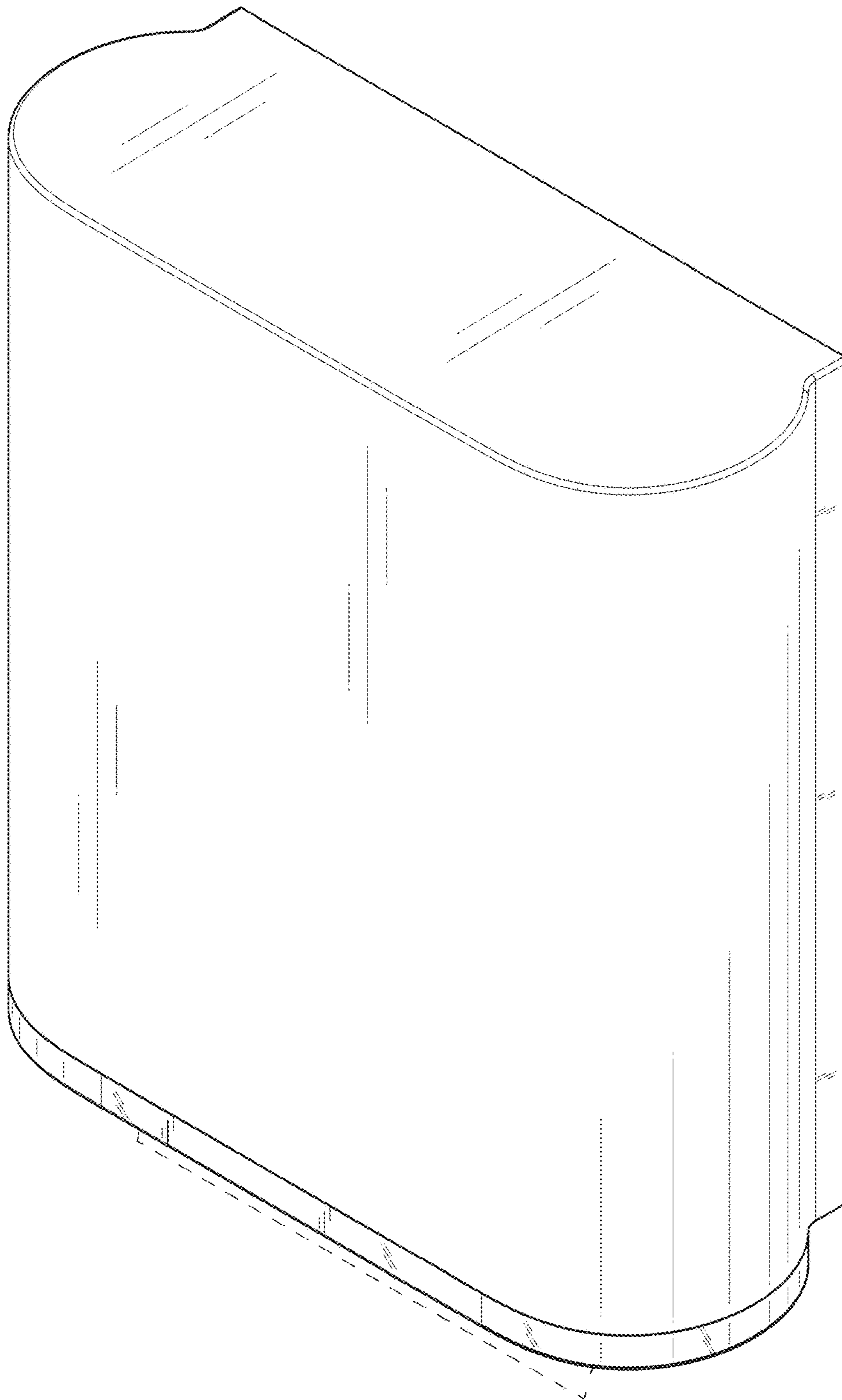

FIG. 9

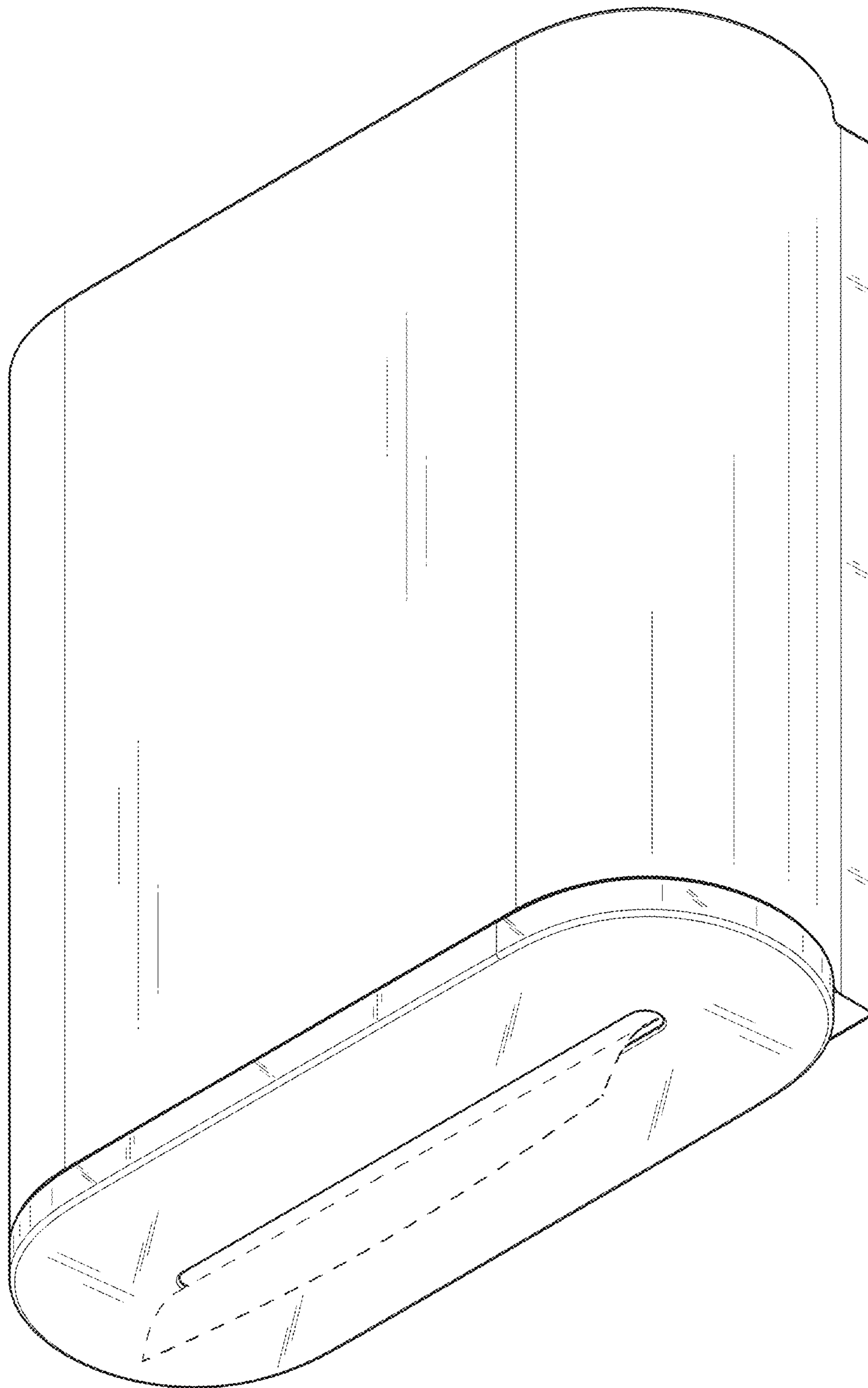

FIG. 10