



US00D927144S

(12) **United States Design Patent** (10) **Patent No.:** **US D927,144 S**  
**Tsakiris** (45) **Date of Patent:** **\*\* \*Aug. 10, 2021**

(54) **PROMOTIONAL CAP STRAP COVER**

20, 2017; URL: <https://www.youtube.com/watch?v=B4jokbKqS0s>.  
(4 pgs).

(71) Applicant: **Theodore Tsakiris**, Honolulu, HI (US)

(Continued)

(72) Inventor: **Theodore Tsakiris**, Honolulu, HI (US)

*Primary Examiner* — Jasmine Mlinarcik

(\*) Notice: This patent is subject to a terminal disclaimer.

(74) *Attorney, Agent, or Firm* — Seth M Reiss, AAL, ALLLC

(\*\*) Term: **15 Years**

(57) **CLAIM**

(21) Appl. No.: **29/677,636**

I claim the ornamental design for a promotional cap strap cover, as shown and described.

(22) Filed: **Jan. 22, 2019**

**Related U.S. Application Data**

**DESCRIPTION**

(63) Continuation of application No. 29/562,030, filed on Apr. 21, 2016.

(51) **LOC (13) Cl.** ..... **02-03**

(52) **U.S. Cl.**  
USPC ..... **D2/891**; D2/639; D20/27

(58) **Field of Classification Search**  
USPC ..... D2/500, 639, 610, 611, 705, 857, 858,  
D2/999, 865, 866, 869, 872, 874, 877,  
(Continued)

FIG. 1 is a top perspective view of the promotional cap strap cover of the subject invention mounted on the back strap of a cap, viewed from the inside of the cap;  
FIG. 2 is a top view of the promotional cap strap cover depicted in FIG. 1, the bottom view being a mirror image thereof;  
FIG. 3 is a rear view of the promotional cap strap cover of the subject invention mounted on the back strap of a cap;  
FIG. 4 is a front view of the promotional cap strap cover of the subject invention mounted on the back strap of a cap, viewed from the inside of the cap;  
FIG. 5 is a side end view of the promotional cap strap cover of the subject invention mounted on the back of a cap strap, the other side view being a mirror image thereof.  
FIG. 6 is a top perspective view of the promotional cap strap cover of the subject invention, mounted on the back strap of a cap, taken from the rear of the cap.  
The broken lines along the surfaces of the promotional cap strap cover depict environmental structure for the purpose of illustrating placement of promotional markings on the promotional cap strap cover and do not form part of the claimed design. The broken line outline of the cap illustrates the environment of the promotional cap strap cover and forms no part of the claimed design.

(56) **References Cited**

**U.S. PATENT DOCUMENTS**

2,263,651 A \* 11/1941 Silberman ..... A44B 19/34  
24/414  
4,678,205 A \* 7/1987 Wold ..... B60R 22/00  
280/808

(Continued)

**FOREIGN PATENT DOCUMENTS**

WO WO9413163 A1 6/1994

**OTHER PUBLICATIONS**

Welding Fabrication Basics—Part 1, [on-line video]; [published to the Internet on Sep. 22, 2012]; [retrieved from the Internet on Aug.

**1 Claim, 3 Drawing Sheets**

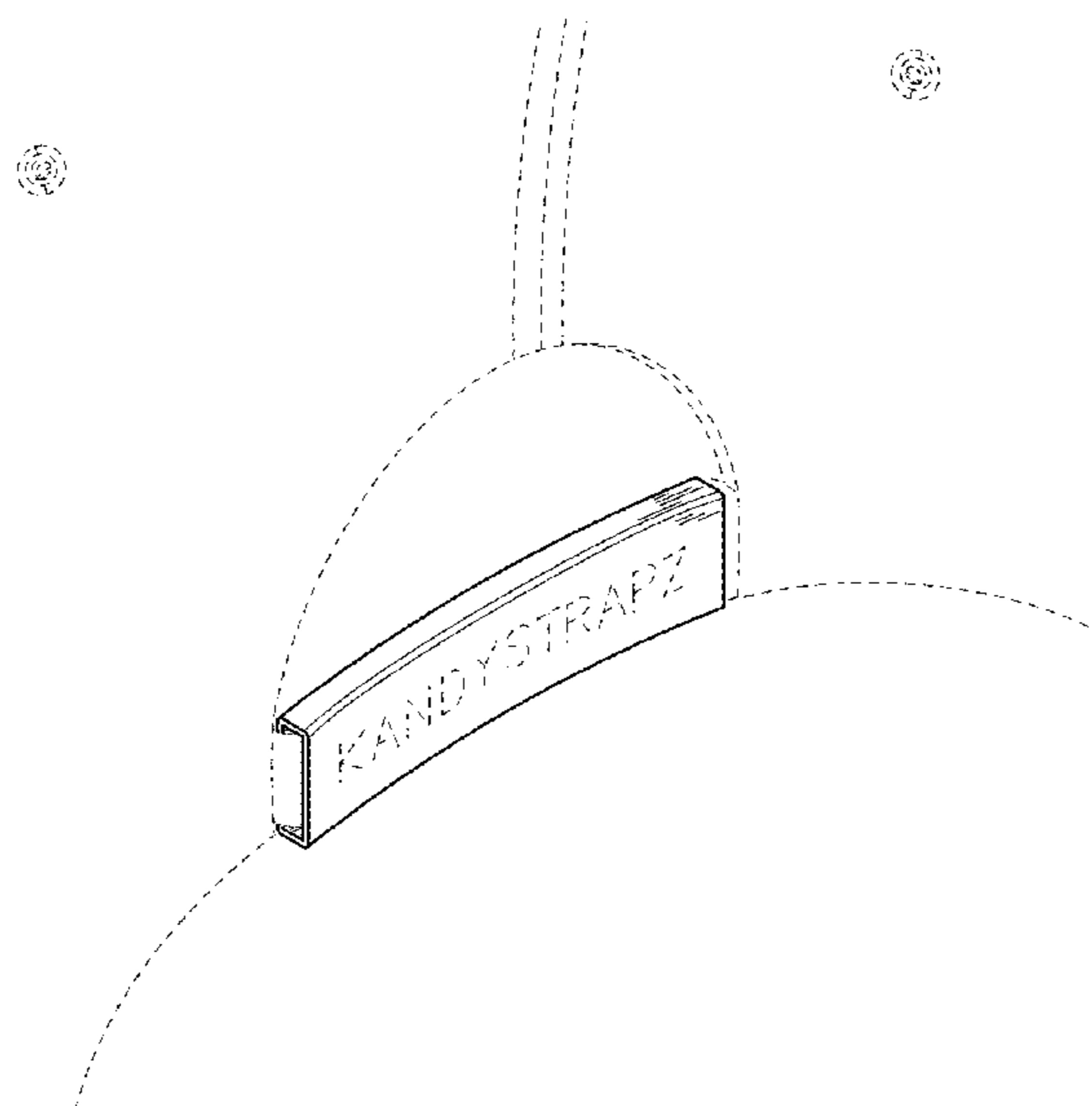

(58) **Field of Classification Search**

USPC ..... D2/880, 881, 882, 884, 891, 895;  
                   D3/221; D11/200; D20/27; D28/41;  
                   D29/114; D16/339; D25/38.1, 126, 164  
 CPC ..... A41B 7/02; A41D 13/08; A41D 13/087;  
                   A41D 20/00; A42B 1/00; A42B 1/002;  
                   A42B 1/004; A42B 1/006; A42B 1/02;  
                   A42B 1/206; A42B 1/22; A42B 1/24;  
                   A42B 1/248; A42C 5/00; A42C 5/02;  
                   A45C 1/04; A45C 13/08; A63B 21/4019;  
                   A43B 21/4021; B25G 3/00; D05C 17/00;  
                                                           Y10S 2/11

See application file for complete search history.

(56) **References Cited**

U.S. PATENT DOCUMENTS

5,315,714 A	5/1994	Peters	
D354,842 S	1/1995	Imre	
5,383,846 A *	1/1995	Short	A41D 13/087 602/59
5,428,844 A	7/1995	Dougherty	
5,499,502 A	3/1996	Rose	
5,519,892 A	5/1996	Pizzacar	
5,546,605 A *	8/1996	Mallardi	A42B 1/22 2/181
D373,454 S	9/1996	Ramirez	
5,554,076 A *	9/1996	Clark	A63D 5/00 2/21
5,600,855 A	2/1997	Ramirez	
5,687,425 A *	11/1997	Blosser	A42B 1/22 2/181.4
D396,547 S	8/1998	Capparella	

D396,938 S *	8/1998	Bugatti	D2/639
5,857,220 A	1/1999	Emey	
5,918,316 A	7/1999	Nathanson	
D412,937 S	8/1999	Franklin	
6,006,362 A	12/1999	Walsh	
6,145,131 A *	11/2000	Huff	A41D 23/00 2/171
6,279,168 B1	8/2001	Bean	
6,282,725 B1 *	9/2001	Vanidestine, Jr.	A42B 3/08 2/209.13
6,484,322 B2 *	11/2002	Christian	A42B 1/24 2/209.13
D605,381 S *	12/2009	Mastrantonio	D2/891
D606,381 S	12/2009	Mastrantonio	
D653,017 S *	1/2012	Hamlin	D2/639
D662,277 S *	6/2012	Dorsey	D2/639
8,869,314 B2 *	10/2014	Peper	A41F 15/00 2/336
D728,862 S *	5/2015	Kurowski	D29/114
D787,132 S *	5/2017	Abbate	D29/114
2002/0108165 A1 *	8/2002	Porter	A42B 1/22 2/195.2
2007/0083986 A1 *	4/2007	Kaiser	A42B 3/08 2/410
2015/0173443 A1	6/2015	Middleton	
2019/0335837 A1 *	11/2019	Kang	A44B 13/0052

OTHER PUBLICATIONS

PVC Hollow Rectangular Bar, Gray, NSF 61, [on-line]; [review posted on Jul. 4, 2012]; [retrieved from the Internet on Aug. 20, 2017]; URL: <https://www.amazon.com/PVC-Hollow-Rectangular-Bar-Gray/dp/B003Y39WCW>. (4 pgs).

\* cited by examiner

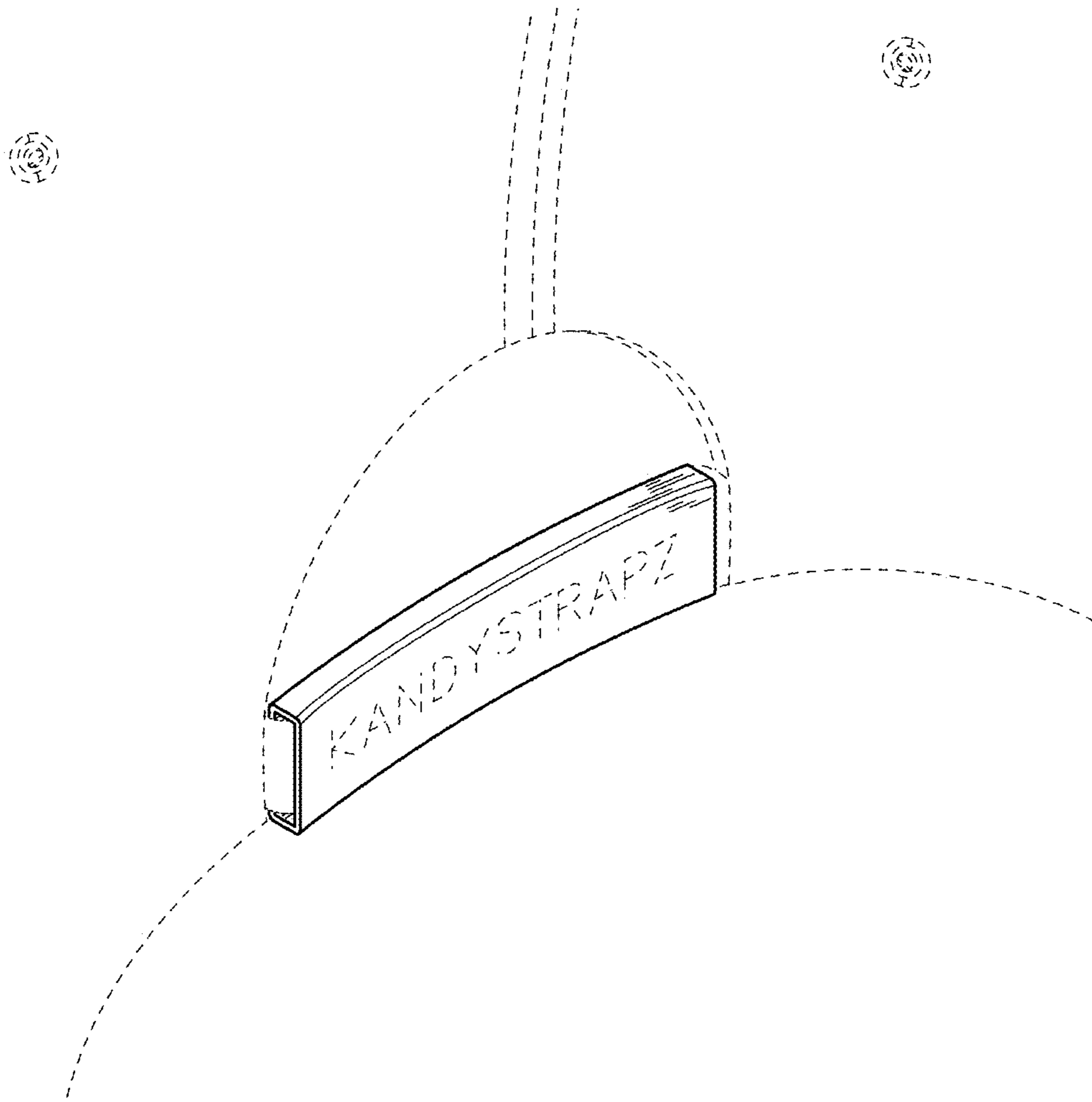

FIG. 1

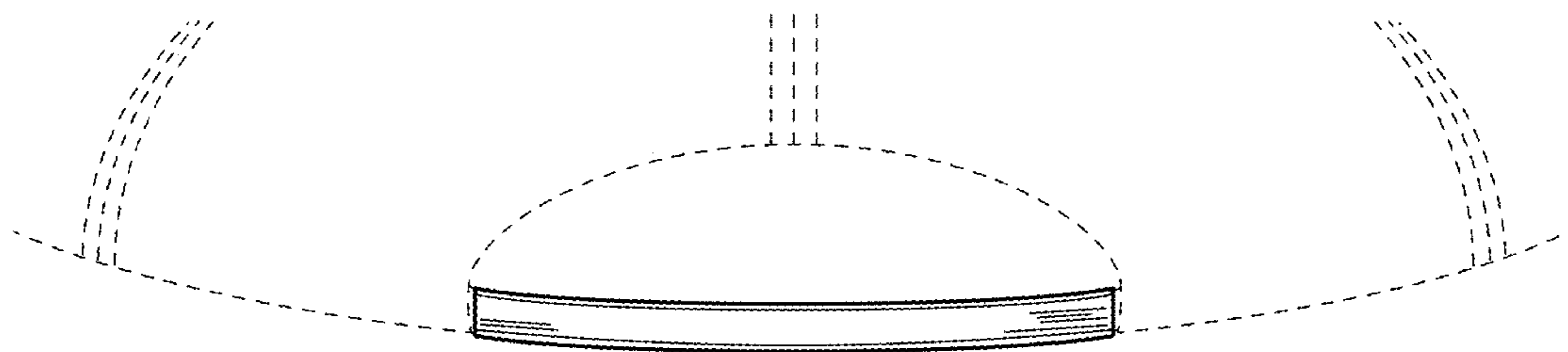

FIG. 2

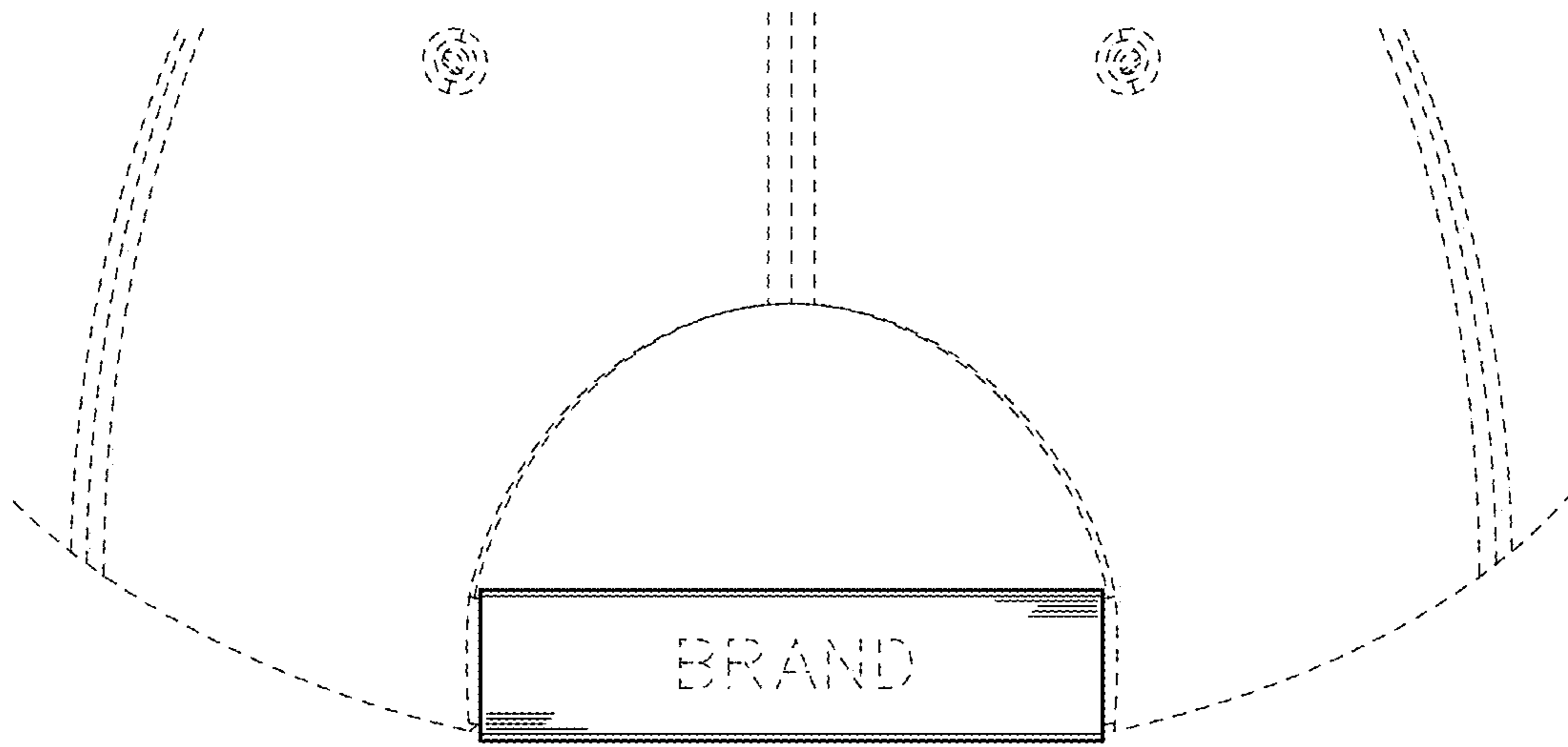

FIG. 3

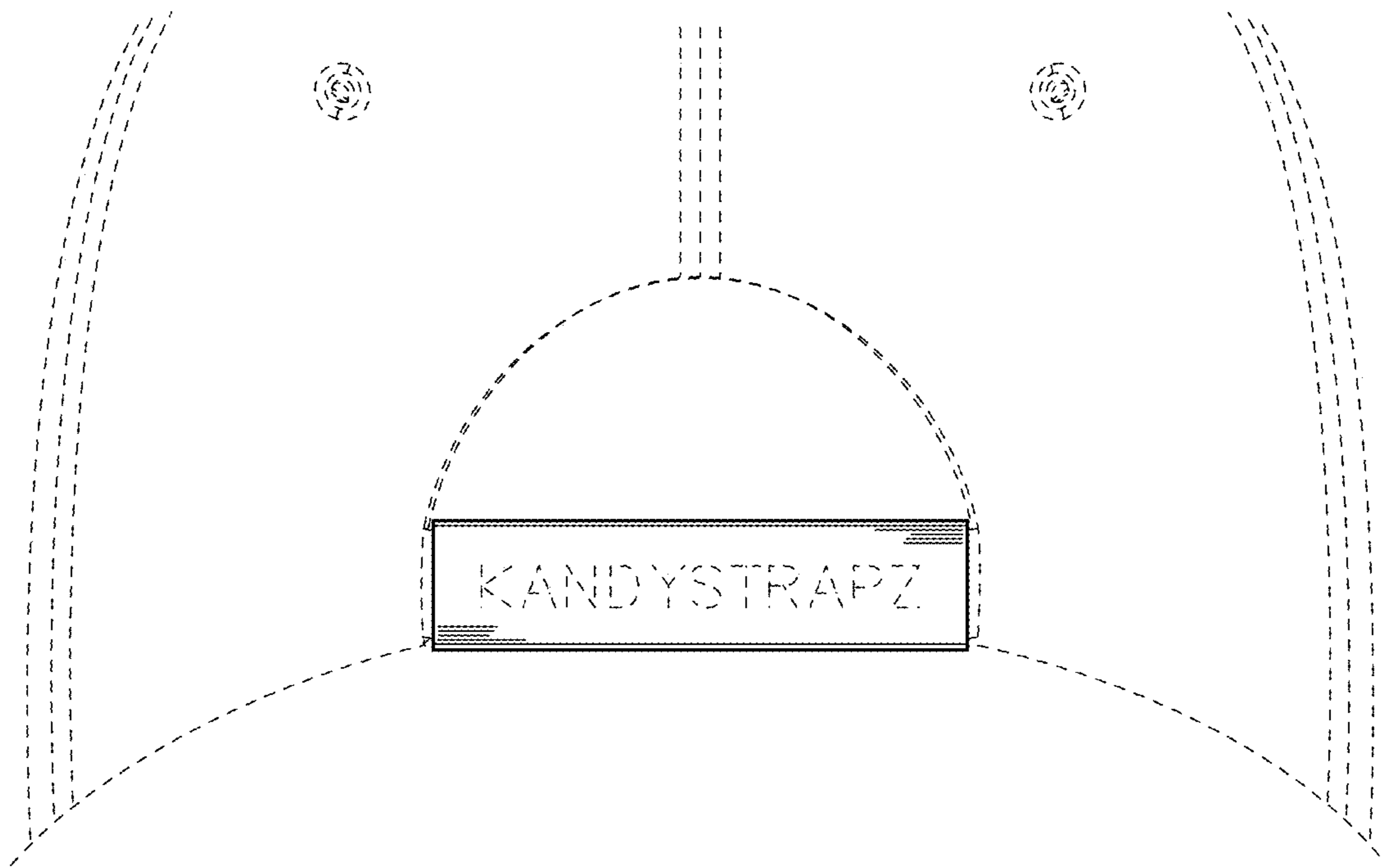

FIG. 4

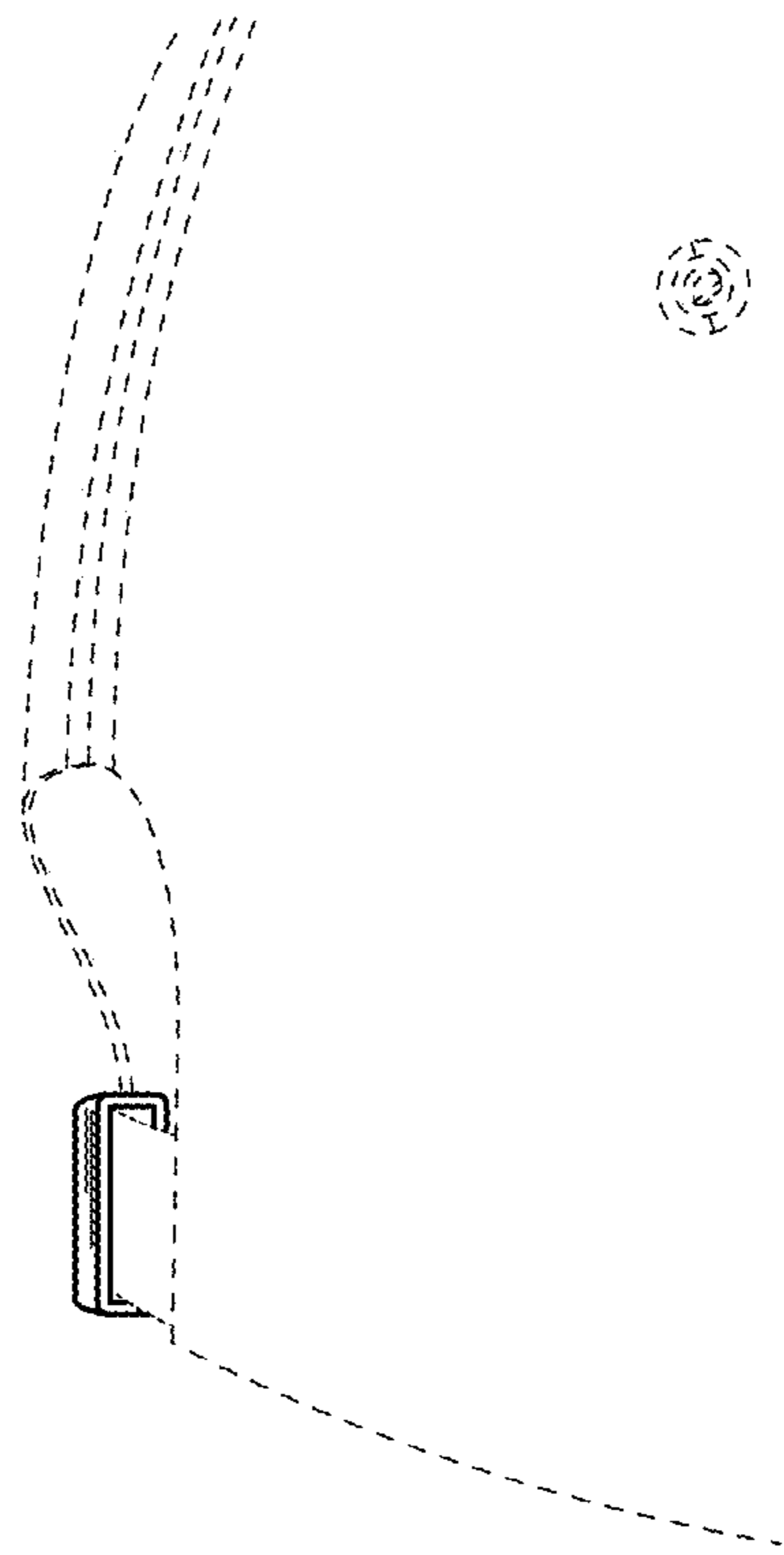

FIG. 5

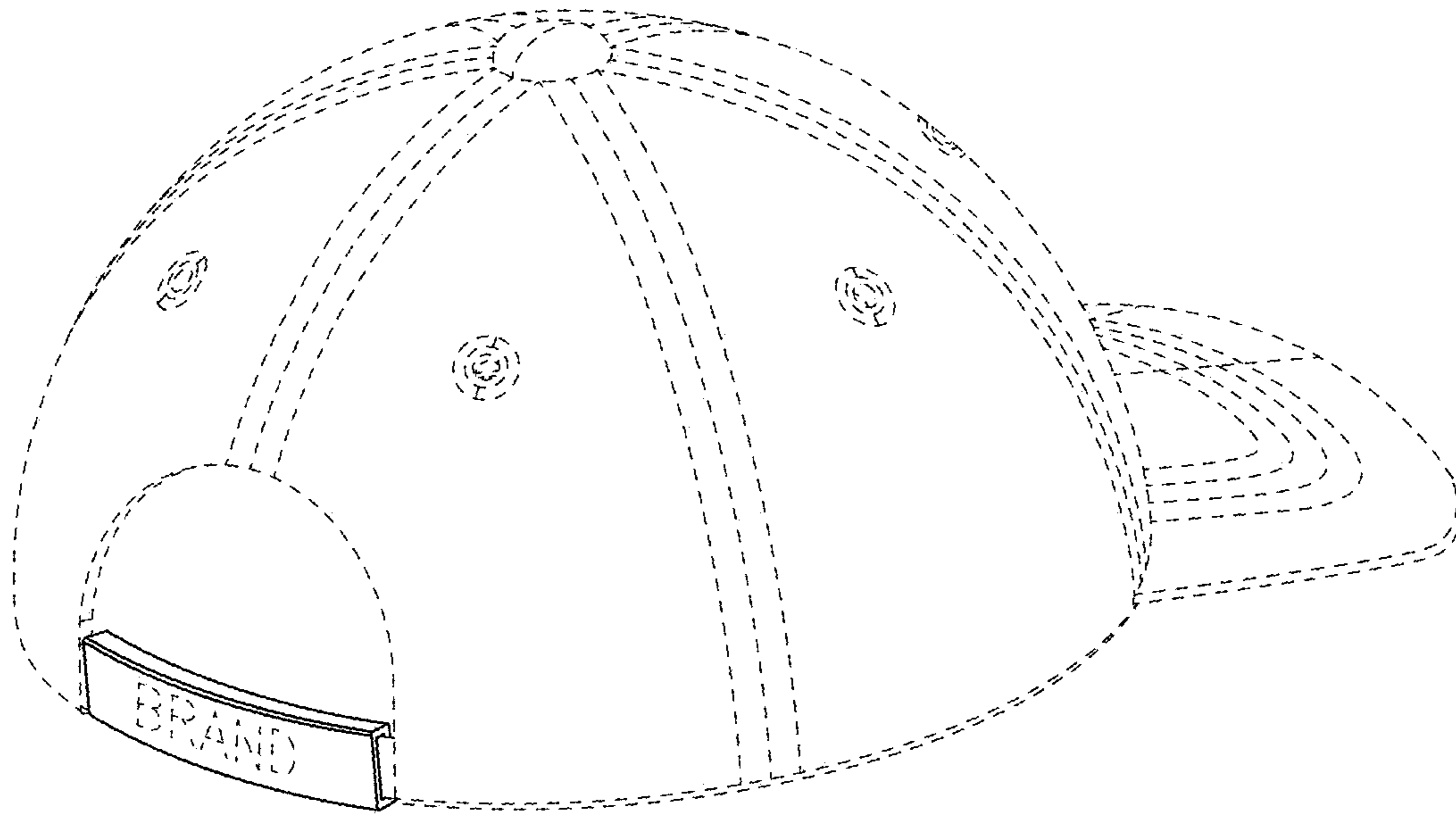

FIG. 6